

RS200

OWNER'S MANUAL



WWW.RS200.ORG

CONTENTS

	Section	Page Nos.
• Introduction	Introduction	1
• Warranty Disclaimer	Warranty	2
• RS200 Owner's Registration	Registration	3
Technical Data	01	1
• Technical Summary and General Layout	01	2
• Specification Details	01	3-5
• Dimensions, weights, and fluid capacities	01	6
• Gearing, road speed/engine speed data, and alternatives	01	6
• Fuel consumption data – Official	01	7
• Electrical wiring diagrams.....	01	8-11
Know Your Car	02	1
• Keys	02	2
• Starter switch/steering lock	02	2
• Vehicle Identification plate (Chassis identification)	02	3
• Location of engine and transmission numbers	02	3
• Interior equipment and controls	02	4-7
• Instruments, warning lights, and switches	02	8-13
• Radio installation	02	14
• Multi-function digital clock	02	15-16
• Heating and ventilation	02	17-19
• Windows, doors, and locks	02	20
Filling Station Information	03	1
• In the Engine Bay	03	2-4
• In the Front Compartment	03	5
• Fluid replenishment	03	6
• Battery checks and charging	03	7-8
• Tyres and tyre pressures	03	9

	Section	Page Nos.
Roadside Emergencies, and Minor Adjustments	04	1
• Towing and Jacking	04	2-3
• Spare Wheel, and wheel changing	04	4-5
• Starting, using 'Jumper' cables	04	6
• Bulb replacement	04	7-11
• Fuses, Relays, and replacement	04	12-15
• Drive and Alternator belt adjustment	04	16
• Wiper blades and windscreen washers	04	17-18
• Fault Finding and diagnosis	04	19-24
Driving the car	05	1
• Starting the engine from cold	05	2
• Starting with a Hot engine	05	2
• Starting a 'flooded' engine	05	2
• Running In – from New	05	3
• Running In – after a major rebuild	05	3
• Braking, and the Dual Hydraulic System	05	4-5
• Driving Methods – hints from Jackie Stewart	05	6-8
• Winter motoring	05	9
• Towing, and roof racks	05	9
Regular Maintenance, and Care	06	1
• Recommended Driver Maintenance	06	2
• Oils, fluids and greases	06	2
• Engine Oil level	06	3
• Transmission Oil level	06	4
• Brake and Clutch fluid levels	06	5
• Cooling system	06	5
• Battery	06	6
• Ignition system	06	7
• Checking for leaks, and corrosion	06	8
• Tyres and chains	06	9
• Seat belts, seats, and fittings	06	10-11
• Car care (exterior and interior)	06	12-14
• Recommended lubricants and fluids	06	15-16

	Section	Page Nos.
Specification, Equipment, and Component Changes	07	01
• Engine and turbocharging installation	07	2-20
• Cooling system	07	21-24
• Transmission	07	25-40
• Front suspension	07	41-52
• Steering	07	53-58
• Rear suspension	07	59-69
• Brakes	07	70-79
• Fuel system	07	80-82
• Body shell	07	83-93
• Electrical equipment	07	94-110

WWW.RS200.ORG

Your Personal Contact at Ford	08	1
• To learn more about your RS200	00	2
After-sales Newsletters, and Bulletins	09	1
Original Information for the Motoring Press	10	1
• The Press Pack issued for the RS200, in 1984	10	2
Parts List	11	00
• Introduction	11	00
• Body/chassis unit, trim and fittings	11	00
• Engine and turbocharging installation	11	00
• Front and rear suspension, wheels and tyres	11	00
• Front and rear axles, and drive shafts	11	00
• Brakes	11	00
• Transmission, transfer box, and controls	11	00
• Clutch, housing and controls	11	00
• Exhaust system	11	00
• Fuel tanks and Fuel lines	11	00
• Steering, column and wheel	11	00
• Ventilation and heating	11	00
• Speedometer and other electrical instruments	11	00
• Battery, alternator, distribution, wiring, switches	11	00
• Lighting equipment	11	00
• Miscellaneous	11	00

INTRODUCTION

We are delighted that you have chosen this limited-production, high-performance, FORD car, and we hope it will provide you with a great deal of fast, but safe, motoring.

The RS200 was designed, not only as a very advanced four-wheel-drive road car, but as a machine to form the basis of a truly competitive Group B rally car. Although some existing FORD parts have been used in the design, the general concept and layout is a no-compromise solution to the needs of drivers in this highly sophisticated class of motoring.

In particular, the RS200 is the first-ever FORD car to be sold with a mid-mounted engine, and a two-seater coupe body style with four wheel drive.

To provide for the owner's needs, to enjoy, maintain, and service such a sophisticated car, we are also providing a unique type of Owner's Manual. In addition to the normal information, regarding equipment, function, technical data, and maintenance, for the RS200 we also provide advice on the recommended driving techniques for a four-wheel-drive car, much more owner information than usual on major servicing requirements, and advice on the way to prepare the car for use in competitions.

There is also a complete list of components, with FORD part numbers, of the standard road car.

Because we are anxious to keep in touch with all the original owners, and with those who purchase the car from a previous owner as well, we invite you to complete the Owner's Registration Form which follows this introduction, and return it to us for our records. From time to time, we plan to issue further bulletins about the future development and improvement of the RS200s.

Great care has been taken to ensure that your FORD RS200 complies with the regulations which apply to its use on the road, or in competitions. Should adjustments be required to the car, about which you or your mechanics are not sure, the necessary advice is available from:

**Ford Motor Company Limited,
Motorsport Parts Division,
Arisdale Avenue,
South Ockendon,
Essex,
England. RM15 5TJ
Telephone: 0708-858310
Telex: 897007**

– this will enable you to optimise the settings, and provide maximum performance, roadholding, stability and security for any purpose.

Ford Rallye Sport dealers are at your disposal, to service the car properly, and expertly.

The EEC is progressively adopting a common system of unit measure utilising 'S.I.' units. These units have therefore been predominantly used throughout this publication.

In most cases the 'S.I.' and metric units are identical; therefore the 'S.I.' unit is shown together with the Imperial equivalent. Where the 'S.I.' and metric units are not the same, all three units are quoted. The current emphasis on the use of units means that the designations used must be absolutely correct. This may result in some units appearing unfamiliar. For example, where kilograms or pounds *force* are used (e.g. pressures), as distinct from kilograms or pounds *weight* (e.g. Kerb weight), the units are written as kgf (lbf) and not kg (lb).

The illustrations, technical information and data contained in this publication, to our best knowledge, were correct at the time of going to print. The right to change prices, specifications, equipment and maintenance instructions at any time, without notice, is reserved as part of our policy of continuous development and improvement.

No part of this publication may be reproduced, stored in a retrieval system or transmitted in any form, electronic, mechanical, photocopying, recording, translating or other means without prior permission of Ford Motor Company Limited.

No liability can be accepted for any inaccuracies or omissions in this publication, although every possible care has been taken to make it as complete and accurate as possible.

THE CUSTOMER ASSURANCE

FORD MOTOR COMPANY LIMITED ASSURE YOU THAT IF ANY PART OF YOUR VEHICLE BECOMES DEFECTIVE DUE TO FAULTY MANUFACTURE OR MATERIALS WITHIN 12 MONTHS FROM THE DATE YOU TOOK DELIVERY OF YOUR VEHICLE THE PART WILL BE REPAIRED OR REPLACED BY ANY OF OUR AUTHORISED FORD DEALERS COMPLETELY FREE OF CHARGE.

THE ONLY CONDITIONS ARE:

- The vehicle must not have been neglected, misused, modified or used for racing or rallying.
- The vehicle plated weights must not have been exceeded.
- The vehicle must have been serviced as recommended in the Ford Service Plan.
- This Assurance does not apply to tyres* or to bodywork not supplied by us or to defects arising from the fitting of parts not made or approved by Ford.

The above covers your vehicle against corrosion resulting from faulty manufacture or materials for a period of 12 months from the date you took delivery of your vehicle.

IN ADDITION, IF ANY PART OF THE BODYWORK OF YOUR VEHICLE IS PERFORATED BY CORROSION WITHIN 6 YEARS FROM THE DATE YOU TOOK DELIVERY, THE PART WILL BE REPAIRED OR REPLACED BY AN AUTHORISED FORD DEALER COMPLETELY FREE OF CHARGE.

THE ONLY CONDITIONS ARE:

- The corrosion must not have been caused by, or result from, damage to the bodywork.
- The bodywork of the vehicle must have been cared for in line with the recommendations contained in the Owner Literature relevant to your vehicle.
- Bodywork damage from whatever cause must have been repaired in line with FORD Corrosion Prevention Service and Repair Procedures.
- This Assurance does not apply to bodywork not supplied by us or to body parts other than FORD or Motorcraft, wherever fitted.
- The perforation must have been brought to the attention of an Authorised FORD Dealer at the earliest possible date.

*Tyre manufacturers' own policies for dealing with defects will apply.

- These Assurances apply to FORD cars and estate cars.
- Any part repaired or replaced under these Assurances will be covered for the balance of the appropriate Assurance period.
- These Assurances are given to the first owner and may be transferred for the balance of the appropriate Assurance period to subsequent owners.
- If we have any disagreement about these Assurances which we are unable to resolve we will both abide by the decision of an agreed Arbitrator or, if we are unable to agree, one appointed by the President of the Law Society.
- These Assurances are in addition to, and do not detract from, the contractual rights you have under Statute or at Common Law.
- Batteries receive the additional benefit of a sliding scale adjustment in the event of becoming defective during the second year of service.

Explanatory Notes

In the event of breakdown you should contact your nearest FORD Dealer. Where breakdown occurs during the Assurance period, and is the result of a manufacturing or material defect, reimbursement will be made for roadside or towing assistance provided by this Dealer. Quite naturally, the routine replacement of servicing items which are subject to wear, such as oil filters, spark plugs, ignition points, wiper blades, clutch linings and brake linings, are a part of the normal cost of operating a vehicle and will be carried out under the Assurance only when necessary as a result of a defect in manufacture or material. The same applies to such items as brake adjustment, wheel balancing, and headlamp alignment which may be required from time to time depending on the operating conditions. Nevertheless, in the interests of customer satisfaction any adjustments to door locks and striker plates or adjustments to wheel alignment that are necessary other than as a result of damage will be carried out free of charge during the first 6 months or 6,000 miles, whichever occurs first.

How to benefit from the Customer Assurance

Whenever possible please take your car to the Dealer from whom it was purchased. If it is difficult or impracticable for you to do so you may contact any other Authorised FORD Dealer who will assist or advise you in the same way.

When your vehicle is still operational and safe to drive it is recommended that you arrange an appointment with the FORD Dealer by telephone to avoid having to be without it for a longer time than absolutely necessary. You should have all services carried out in accordance with the FORD Service Plan and recorded in the Vehicle Service Record to ensure full protection under the customer Assurance. The advantages of having your servicing carried out only by Authorised FORD dealers are explained elsewhere in this booklet.

When arriving at the Dealer your 'Owner Certificate', which you will find inside the front cover of this booklet, will introduce you to the Service Department. For this reason it is advisable always to keep this document in your car.

The International Assurance

The Customer Assurance is not restricted to the country in which your vehicle was bought. Throughout Western Europe there are Authorised Dealers in FORD vehicles who will honour the Customer Assurance. A comprehensive list can be obtained from your Dealer on request. Normally, the Customer Assurance will be provided by the Dealer who sold you your vehicle. Should you, however, be travelling outside Western Europe, any Authorised FORD Dealer can undertake emergency type repairs on request. To obtain emergency service under the FORD Customer Assurance you should present your service voucher book to the Dealer.

Very occasionally, circumstances may make it necessary for you to meet the cost of such service. When this happens, retain all invoices, and, if possible, displaced parts, for discussion with your own Dealer on your return home. He will raise the matter with FORD and obtain any reimbursement to which you may be entitled.

WWW.RS200.ORG

RS200 : OWNER'S REGISTRATION

So that we, at FORD, can keep in touch with owners, and so that we can keep a check on the history, and career, of every RS200 built, we invite owners to complete the attached Owner's Registration Form (which has no legal status, nor any legal implication on the owner), and return it to us at:

**Registrar, Graham Robson,
Gint House,
Burton Bradstock,
Bridport,
Dorset,
DT6 4QF.**

We intend to circulate regular bulletins and newsletters regarding the cars, the improvements we develop as a result of further experience with road and competition cars, together with the news of modifications, and new parts (for road and competitions use) which become available for the RS200. Such bulletins will always be issued to the latest known owner of a particular car.

This request does not merely apply to the purchase of a new RS200, but to those drivers who buy the machines in later years. Accordingly, we invite the purchaser of a new RS200 to let us have the White registration form, the second owner the Yellow form, the third owner the Green form, and the fourth owner the Blue form.

Thank you for helping us keep in touch with you!

WWW.RS200.ORG

FORD RS200 : OWNER'S REGISTRATION

First Owner

Vehicle Chassis No. :

Vehicle Engine No. :

Left Hand Drive/Right Hand Drive ? (Please delete inapplicable description)

Date Car Purchased :

Owner's Name :

Owner's Address :

.....

.....

Owner's Telephone No: (Home)..... (Business)

Owner's Telex Number, if any

Mechanic's/Specialist Dealer's Phone number

Mechanic's/Specialist Dealer's Telex number

Mechanic's/Specialist Dealer's Address

.....

.....

.....

.....

Thank you for helping us to keep in contact with this car. Please return this Registration form to:

**Ford Motor Company Limited,
Motorsport Parts Division,
Arisdale Avenue,
South Ockendon,
Essex,
England. RM15 5TJ**

WWW.RS200.ORG

FORD RS200 : OWNER'S REGISTRATION

Second Owner

Vehicle Chassis No. :

Vehicle Engine No. :

Left Hand Drive/Right Hand Drive ? (Please delete inapplicable description)

Date Car Purchased :

Owner's Name :

Owner's Address :

Owner's Telephone No: (Home)..... (Business)

Owner's Telex Number, if any

Mechanic's/Specialist Dealer's Phone number

Mechanic's/Specialist Dealer's Telex number

Mechanic's/Specialist Dealer's Address

Thank you for helping us to keep in contact with this car. Please return this Registration form to:

**Ford Motor Company Limited,
Motorsport Parts Division,
Arisdale Avenue,
South Ockendon,
Essex,
England.
RM15 5TJ**

WWW.RS200.ORG

FORD RS200 : OWNER'S REGISTRATION

Third Owner

Vehicle Chassis No. :

Vehicle Engine No. :

Left Hand Drive/Right Hand Drive ? (Please delete inapplicable description)

Date Car Purchased :

Owner's Name :

Owner's Address :

Owner's Telephone No: (Home)..... (Business)

Owner's Telex Number, if any

Mechanic's/Specialist Dealer's Phone number

Mechanic's/Specialist Dealer's Telex number

Mechanic's/Specialist Dealer's Address

Thank you for helping us to keep in contact with this car. Please return this Registration form to:

**Ford Motor Company Limited,
 Motorsport Parts Division,
 Arisdale Avenue,
 South Ockendon,
 Essex,
 England.
 RM15 5TJ**

WWW.RS200.ORG

FORD RS200 : OWNER'S REGISTRATION

Fourth Owner

Vehicle Chassis No. :

Vehicle Engine No. :

Left Hand Drive/Right Hand Drive ? (Please delete inapplicable description)

Date Car Purchased :

Owner's Name :

Owner's Address :

.....

.....

Owner's Telephone No: (Home)..... (Business)

Owner's Telex Number, if any

Mechanic's/Specialist Dealer's Phone number

Mechanic's/Specialist Dealer's Telex number

Mechanic's/Specialist Dealer's Address

.....

.....

.....

.....

Thank you for helping us to keep in contact with this car. Please return this Registration form to:

**Ford Motor Company Limited,
Motorsport Parts Division,
Arisdale Avenue,
South Ockendon,
Essex,
England.
RM15 5TJ**

WWW.RS200.ORG

TECHNICAL DATA 01

Index

	Page
Technical Summary and General Layout	2
Specification Details	3-5
Dimensions, Weights and Fluid capacities	6
Gearing, road speed/engine speed data	6
Fuel consumption data	7
Electrical wiring diagrams.....	8-11

WWW.RS200.ORG

TECHNICAL SUMMARY

The FORD RS200 has been specially designed by our engineers, not only to be a very fast, stable, and safe road car, but also to form the advanced basis for preparation as a Group B competition car. Compared with all other FORD passenger cars, therefore, it has a unique mechanical layout and body style, though some standard FORD components have been included in the specification.

The RS200 is the first FORD passenger car to combine:

- A mid-mounted turbocharged engine.

- A two-seater sports coupe body style.

- High-technology composite material chassis and body sections.

Specification details of the RS200 are as follows:

GENERAL LAYOUT

Two-seater fixed-roof sports coupe model, with engine mounted behind the seats. Unit-construction chassis/passenger cabin structure, in a combination of aluminium honeycomb sandwich, carbon fibre composite, and steel. Integral tubular roll cage, and additional tubular space-frame sub-assemblies, front and rear, to increase rigidity, provide suspension attachments, and to carry ancillary equipment. 1.8-litre, all-alloy, four-cylinder, D.O.H.C. 16-valve turbocharged engine, with clutch attached, driving forward to front-mounted transaxle assembly containing the five-speed gearbox, and the four-wheel-drive mechanism. Choice of rear-wheel drive or four-wheel-drive, driver-controlled from the driving seat. Cars are delivered with the transmission fixed in four-wheel-drive.

Hinged advanced composite material body sections at front and rear.

All independent suspension, rack-and-pinion steering (left-hand or right-hand steering position), and disc brakes at front and rear.

Complete mechanical, trim, instrumentation, comfort and safety equipment.

WWW.RS200.ORG

SPECIFICATION DETAILS

Engine

Four-cylinder turbocharged Type BDT unit, with aluminium alloy cylinder block and cylinder head. Twin overhead camshafts, belt-driven from nose of crankshaft, and four valves per cylinder. Five crankshaft main bearings. Ford/Bosch fuel injection, allied to turbocharging, with EEC IV electronic engine management system.

Engine mounted behind the passenger compartment, installed at an angle of 23 degrees to the right of vertical, and 6.0 in./152.4 mm to the left of the car's longitudinal centre line.

Dimensions

(Cylinder bore, stroke and cubic capacity)

86.0 mm x 77.62 mm, 1,803.5 c.c. (3.385 x 3.06 in., 110.0 cu. in.)

Compression Ratio

8.2 : 1 (geometric)

Induction

Ford/Bosch fuel injection, allied to electronic engine management system, with Ford EEC IV control.

Fuel grade required: 96 Octane (Super)

Supply by electric fuel pumps.

Turbocharger

Garrett AiResearch T31/T04E, feeding pressurised air through air-to-air intercooler. Maximum boost 0.75 Bar (11.0 psi),

Ignition System

Ford EEC IV microprocessor electronic engine management system.

12 volt Ford EEC IV ignition coil.

Motorcraft HG2 (Resistive) sparking plugs, with 0.025 in. gap. For sustained high speed usage use 461 plugs.

Lubrication

By 'dry sump' installation, with separate oil reservoir mounted above and behind engine, on chassis cross-member. Capacity 10 litres (17.6 Imperial pints).

Cooling System

Water (with permanent 50/50 per cent anti-freeze additive mixture), engine driven pump, and thermostat. Cooling radiator at front of car, with thermostatically controlled, electrically driven, cooling fan.

Maximum engine speed 7,400 rpm

Maximum power

(DIN) PS 187 (250)
at revs/min 6,500-7,000

Maximum torque

mkg (lb.ft.) 29.8.0(215)
at revs/min 4,000-5,000

Transmission

Five-speed, manual gearbox, with synchromesh on all forward gears in transaxle at front of car, separate from engine. Clutch and transfer gears in unit with engine. Cars are delivered with the transmission fixed in four-wheel-drive, but after a simple modification, to be made by the driver, there is a choice of four-wheel-drive, or rear-wheel-drive only, by driver control of lever on transmission tunnel, in passenger cabin. Front, centre and rear differentials. Lockable centre differential. Exposed drive shafts to all driven wheels.

Clutch and Transfer Gears

Mounted at front of engine. Twin-plate, diaphragm spring clutch, with 7.25 in/18.4 cm diameter friction discs, and hydraulic actuation. Quick change, helical spur, primary drive transfer gears, ratio 1.043:1.

Gearbox

Five-speed and reverse, synchromesh on all forward gears, mounted in same casing as centre differential, rear-drive/four-wheel-drive control, and front differential. Centrally positioned, remote control, gear change lever, on transmission tunnel, between passenger seats.

Gear Ratios

Gear	Ratio	Overall ratio including transfer gear	Overall ratio to wheels
Transfer	1.043	–	–
First	2.692	2.809	12.289
Second	1.824	1.903	8.326
Third	1.318	1.375	6.016
Fourth	1.043	1.088	4.760
Fifth	0.786	0.820	3.587
Reverse	3.083	3.216	14.070
Final drive	4.375	–	–

Drive to Wheels

From front of gearbox to cuff-joint selector controlling drive to front wheels. In rear-wheel-drive mode, full engine torque passes to the rear differential only. In four-wheel-drive mode, torque passes to central torque splitting differential, with outputs to the front differential (between front drive shafts), and by propeller shaft to the rear differential (mounted behind the engine).

Two propeller shafts. Primary shaft links clutch/transfer gear housing to main transaxle. Two-piece shaft links transaxle, to rear differential. Constant velocity joints throughout.

All differentials are Ferguson viscous-coupling type, with epicyclic gear trains and limited-slip mechanisms, by specially-shaped discs interfaced through silicone fluid in shear.

Cars are delivered with the transmission fixed in four-wheel-drive mode, with an unlocked centre differential. Normal torque split is 37 per cent (front)/ 63 per cent (rear), in four-wheel-drive mode. On rally specification vehicles, centre differential may be locked by moving the two-wheel-drive/four-wheel-drive lever to an extra position. This provides direct mechanical connection between front and rear differentials, and a 50 per cent/50 per cent torque split. The lever may also be used to select RWD with all power going to the rear wheels.

Exposed, universally jointed, drive shafts to all four wheels.

Front suspension

Independent, by double wishbones, including castor adjustment at angled front lower links. Twin concentric coil spring/damper units, with screw-collar ride height adjustment, mounted between upper wishbone and structural sub-frame. Two alternative chassis mounting attachments, to provide different ground clearance settings for smooth or rough road running.

Anti-roll bar linking bottom wishbones.

Ride height: 180 mm (7.09 in) ground clearance, measured from sill to ground at kerb weight.

Castor: 2½ degrees positive subject to bump steer.

Wheel camber: 1½ degrees negative.

Toe in: Nil (parallel wheels).

Steering

Rack and pinion, with choice of left-hand or right-hand steering. Steering column with two universal joints. 2.6 turns lock-to-lock.

Rear Suspension

Independent, by double wide-based wishbones, combined with a 'toe-in control' Lower link. Twin concentric coil spring/damper units, with screw collar ride-height adjustment, mounted between cast vertical link, and structural sub-frame. Two alternative chassis mounting attachments, to provide different ground clearance settings for smooth or rough-road running.

Anti-roll bar linking bottom wishbones.

Ride height: 180 mm (7.09 in.) ground clearance, measured from sill to ground at kerb weight.

Camber: 1 degree negative.

Toe in: 0 deg. 15 min. toe-in.

Brakes

Hydraulic, with dual circuits, split front to rear, and ventilated discs at front and rear. Fluid reservoirs mounted near tubular cross-member between front suspension pick-up points. Mechanical, cable-operated, handbrake, by separate calipers, with lever mounted on transmission tunnel, between passenger seats. Front discs 285 mm diameter x 25 mm thick (11.2 x 1.0 in.), with four-piston light alloy caliper. Rear discs 285 mm diameter x 25 mm thick (11.2 x 1.0 in.), with four-piston light alloy caliper. Separate mechanical actuation caliper for hand-brake operation.

Wheels and Tyres

Ford RS eight-spoke alloy road wheels, and Pirelli P700 tyres, with four dowelled-stud fixings.

Wheel diameter 16 in./406 mm; rim section 8J (8.0 in./203 mm rim width).

Tyres: 225/50-VR-16 in., radial ply, with nominal rolling radius of 308.8 mm/12.15 in., rolling circumference 1940 mm/76.4 in. 515.5 revs/km, or 829.4 revs/mile.

Tyre pressures (Front and Rear): 2.0 Bar/29 psi. One spare wheel/tyre, normally mounted behind the engine/rear final drive, accessible by raising rear body section.

Bodywork: Paint System employed

Although a variety of body shell and structural chassis materials have been used in the construction of the RS200, it has been painted in exactly the same way as any other 1985 model-year British Ford.

Every RS200 has been painted DIAMOND WHITE, a colour which is coded XSC 691.

DIMENSIONS, WEIGHTS AND FLUID CAPACITIES

DIMENSIONS

Overall length	4000 mm (13ft. 1.5 in.)
Overall width	1764 mm (5ft. 9.4 in.)
Overall height	1322 mm (4ft. 4.0 in.)
Wheelbase	2530 mm (8ft. 3.6 in.)
Front track	1502 mm (4ft. 11.1 in.)
Rear track	1498 mm (4ft. 11.0 in.)
Ground clearance	180 mm (7.1 in.)
Overhang (front)	788 mm (2ft. 6.6 in.)
Overhang (rear)	692 mm (2ft. 3.2 in.)
Kerb weight (with full fuel tank, all liquids, tools and spare wheel)	1180 kg (2607 lb)
Axle weights – front	545 kg (1204 lb)
– rear	635 kg (1403 lb)
Maximum permissible weight	1360 kg (3004 lb)
Maximum front axle weight	680 kg (1502 lb)
Maximum rear axle weight	680 kg (1502 lb)

Capacities

Fuel tanks	89.9 litres + 10 litres Expansion Capacity (19.8 + 2.2 Imp. galls)
Engine sump (incl. tank)	10 litres (17.6 Imperial pints)
Transaxle	3 litres
Rear axle	1.3 litres (2.25 Imperial pints)

GEARING, AND ROAD SPEED/ENGINE SPEED DATA

Gear Used	Kph/mph per 1,000 engine rpm	Kph/mph at 6,000 engine rpm (peak of power curve)	Kph/mph at 7,000 engine rpm
First	9.47/5.88	56.82/35.28	66.29/41.16
Second	13.98/8.68	83.88/52.08	97.86/60.76
Third	19.34/12.02	116.04/72.12	135.38/84.14
Fourth	24.45/15.19	146.70/91.14	171.15/106.33
Fifth (Top)	32.44/20.16	194.64/120.96	227.08/141.12
Reverse	8.27/5.14	49.62/30.84	57.89/35.98

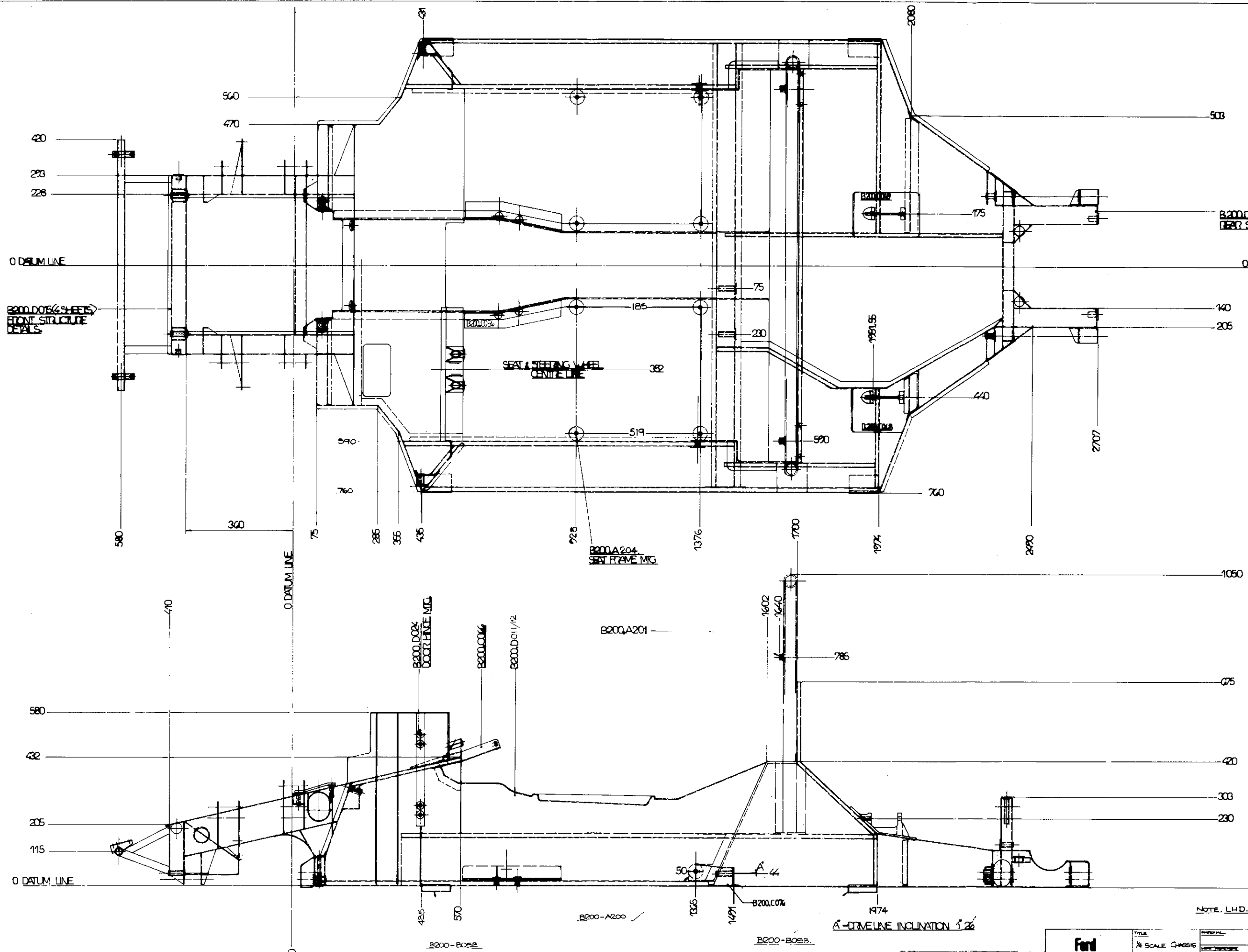

NOTE: L.H.D. CHASSIS DRAWN.

1985	571	NOV 84	1
2	A204	HGAPTB	(376
NOV 84			
DRAWN DATE			

Ford
tel. 0804 830423

1/4 SCALE CHASSIS
FRAME LAYOUT.

APPROVED	DRAWN	DATE
		6 Nov 84

DRAWING No. B200-

FUEL CONSUMPTION DATA

Fuel Consumption:

The results recorded in an official fuel economy certificate of the officially approved tests for determining fuel consumption are given in this section. All figures in mpg are from officially approved tests under the Passenger Car Fuel Consumption Order 1977.

These results do not express or imply any guarantee of the fuel consumption of any individual car. Individual vehicles are not tested and there are inevitable differences between different examples. In addition, any car may incorporate particular modifications.

Elsewhere in this Manual are details of the car's fuel capacity, and of the minimum octane rating of fuel required. Using fuel of inferior quality can cause engine damage.

The fuel consumption has been measured for each of the following driving conditions with the vehicle loaded to approximately half the permitted maximum payload:

- A – simulated urban driving (ECE 15 cycle)
- B – constant speed driving at 90 km/h (56 mph)
- C – constant speed driving at 120 km/h (75 mph)

Driving habits, road, vehicle and weather conditions will cause actual fuel consumption to vary from the figures given below. The way you drive, and regular maintenance of the vehicle by a FORD dealer, are decisive factors towards economic driving.

Model	Body Style	Trans- mission	Final Drive Ratio	Tyre Size	Fuel consumption					
					A mpg	B mpg	C mpg	A L/100 Km	B L/100 Km	C L/100 Km
RS200	Coupe	5-speed	4.375	225/50 VR-16	14.3	31.5	25.0	19.81	8.97	11.3

Ignition Timing Data: FORD EEC IV Engine Management System

The following ignition advance curve applies to the standard production RS200, with the engine vacuum *off*:

Engine rpm	Ignition Advance (before TDC) (degrees)
590	9.1
700	10.2
850	11.9
1100	13.7
1600	17.9
2000	14.4
2500	16.0
3000	16.8
3500	17.2
4000	22.5
4900	23.2
5800	21.1
6600	23.9

There is one Top Dead Centre mark on the RS200's engine, this being on the crankshaft pulley.

ELECTRICAL WIRING DIAGRAMS

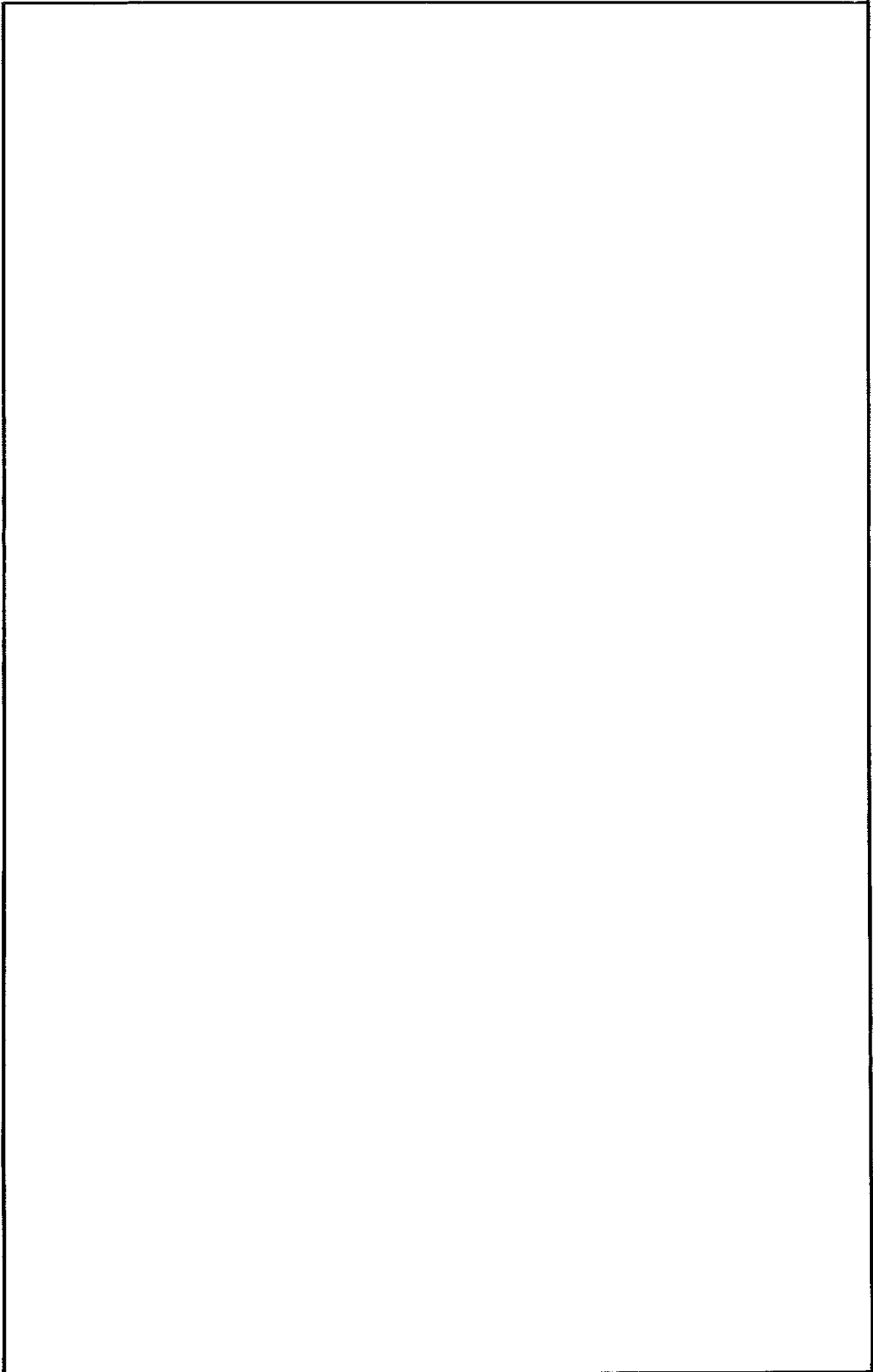

WWW.RS200.ORG

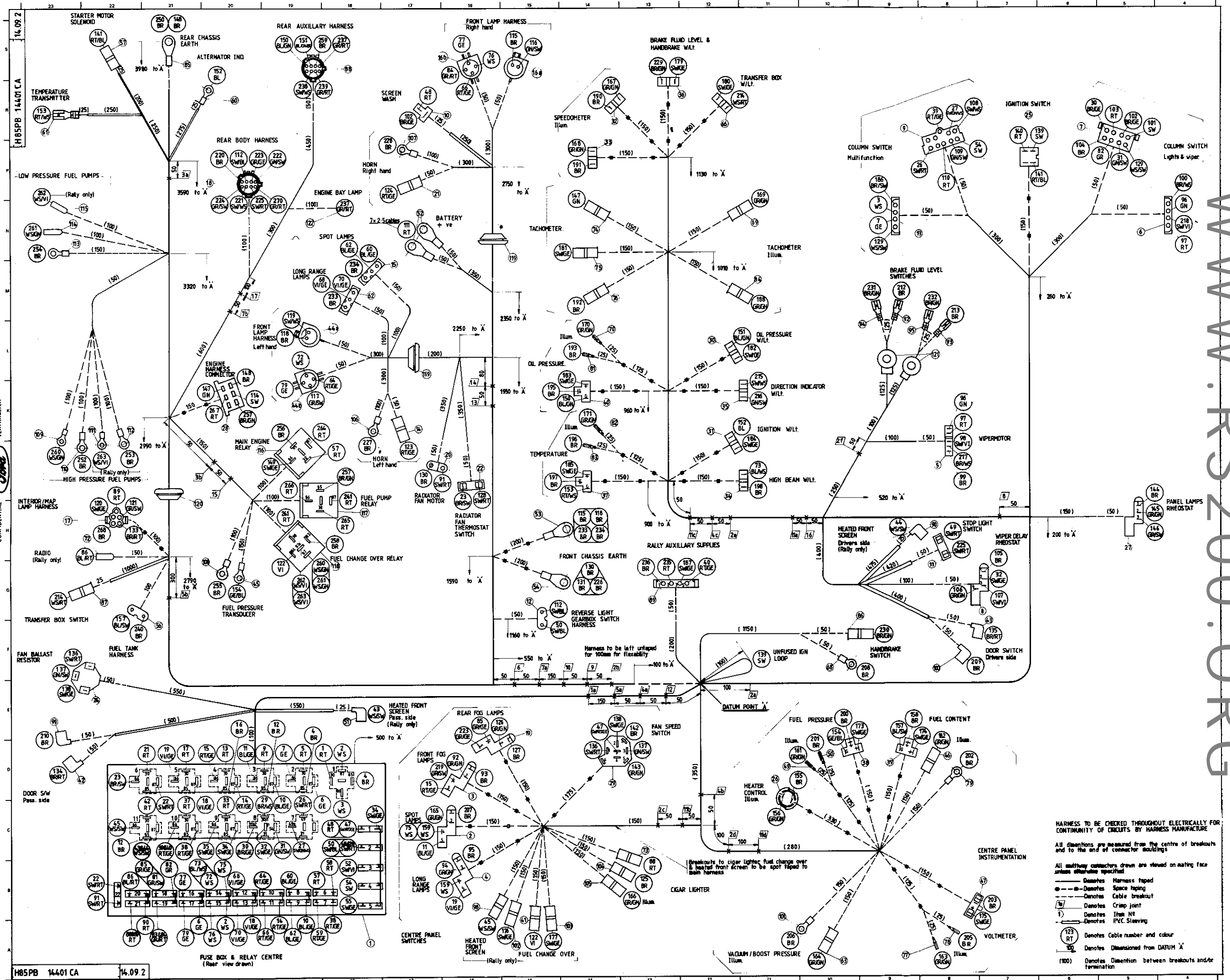

H85PB 14401 CA 14.09.2

ISSUE 1

WIRING ASSY - MAIN HARNESS 1 of 11 RS200 SECTION 01 - 8

WWW.RS200.ORG

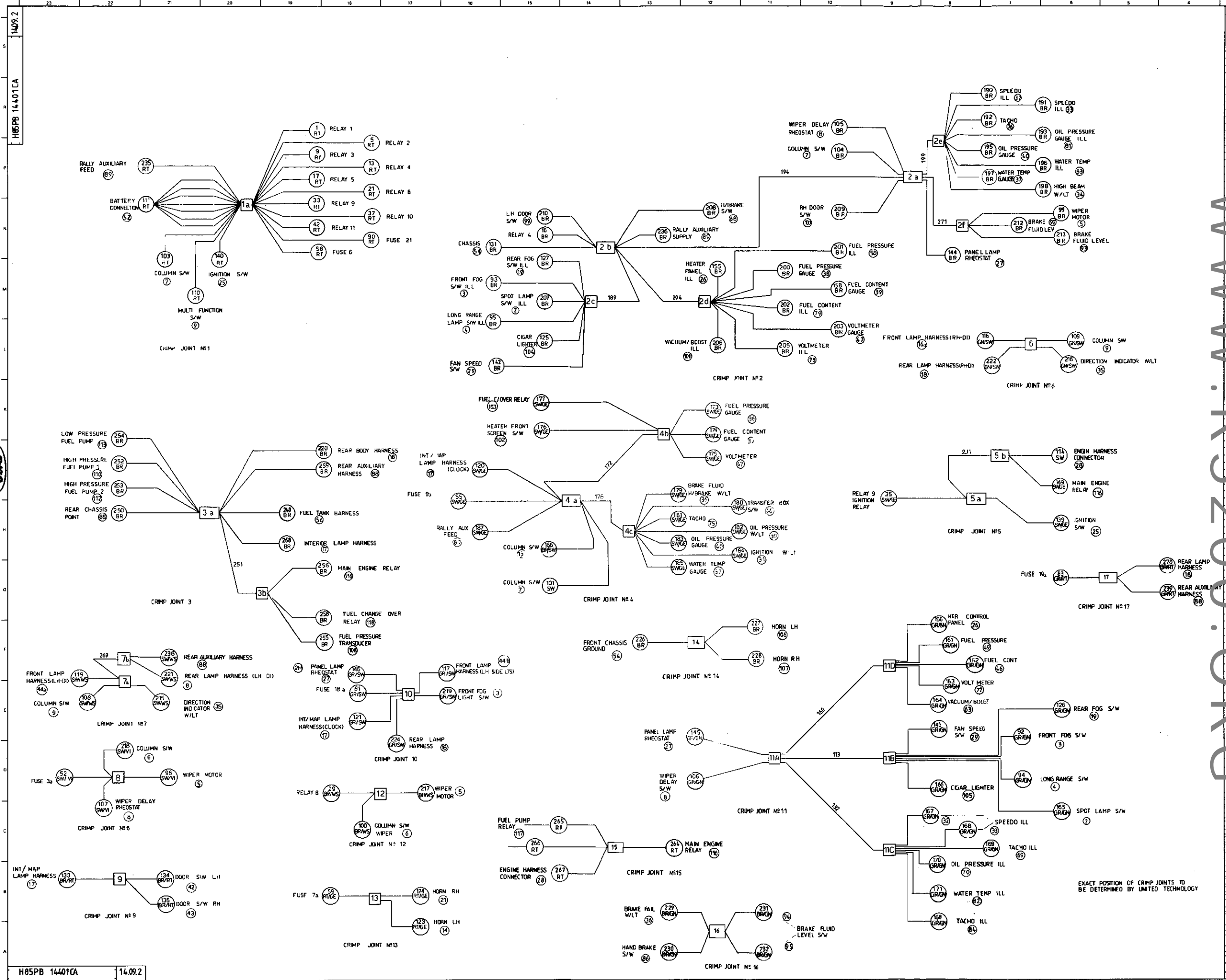

VERTRAULICH
CONFIDENTIAL

WWW.RS200.ORG

ITEM	DESCRIPTION	PART NO
1	MODULE EEC IV	446-14489-C
2	THROTTLE POSITION SENSOR	25AB144624 AA
3	WATER TEMP SENSOR	51EB 144654 DA
4	AIR TEMP SENSOR	05AB 144656 BA
5	PRESSURE SENSOR	05AB 144656 BA
6	WATER TEMP TRANSDUCER	25AB 144624 AA
7	INJECTOR # 8	43B 144544 AA
8	INJECTOR # 9	43B 144544 AA
9	INJECTOR # 10	43B 144544 AA
10	INJECTOR # 11	43B 144544 AA
11	DISTRIBUTOR SOCKET	73G 21 208 BA
12	DIAGNOSTIC SOCKET	208 144604 BA
13	SOLENOID	51 102 03
14	SOLENOID	51 102 03
15	SOLENOID	51 102 03
16	SOLENOID	51 102 03
17	SOLENOID	51 102 03
18	SOLENOID	51 102 03
19	SOLENOID	51 102 03
20	SOLENOID	51 102 03
21	SOLENOID	51 102 03
22	SOLENOID	51 102 03
23	SOLENOID	51 102 03
24	SOLENOID	51 102 03
25	SOLENOID	51 102 03
26	SOLENOID	51 102 03
27	SOLENOID	51 102 03

ITEM	COLOR	SIZE	DESTINATION
1	GN	1mm ²	CRIMP JOINT Z1
2	RT/SW	1mm ²	WATER TEMP TRANSDUCER
3	BR	1mm ²	TFI
4	RT/SW	1mm ²	TFI
5	RT/SW	1mm ²	TFI
6	RT/SW	1mm ²	TFI
7	RT/SW	1mm ²	TFI
8	RT/SW	1mm ²	TFI
9	RT/SW	1mm ²	TFI
10	RT/SW	1mm ²	TFI
11	RT/SW	1mm ²	TFI
12	RT/SW	1mm ²	TFI
13	RT/SW	1mm ²	TFI
14	RT/SW	1mm ²	TFI
15	RT/SW	1mm ²	TFI
16	RT/SW	1mm ²	TFI
17	RT/SW	1mm ²	TFI
18	RT/SW	1mm ²	TFI
19	RT/SW	1mm ²	TFI
20	RT/SW	1mm ²	TFI
21	RT/SW	1mm ²	TFI
22	RT/SW	1mm ²	TFI
23	RT/SW	1mm ²	TFI
24	RT/SW	1mm ²	TFI
25	RT/SW	1mm ²	TFI
26	RT/SW	1mm ²	TFI
27	RT/SW	1mm ²	TFI

ITEM	COLOR	SIZE	DESTINATION
1	GN	1mm ²	CRIMP JOINT Z1
2	RT/SW	1mm ²	WATER TEMP TRANSDUCER
3	BR	1mm ²	TFI
4	RT/SW	1mm ²	TFI
5	RT/SW	1mm ²	TFI
6	RT/SW	1mm ²	TFI
7	RT/SW	1mm ²	TFI
8	RT/SW	1mm ²	TFI
9	RT/SW	1mm ²	TFI
10	RT/SW	1mm ²	TFI
11	RT/SW	1mm ²	TFI
12	RT/SW	1mm ²	TFI
13	RT/SW	1mm ²	TFI
14	RT/SW	1mm ²	TFI
15	RT/SW	1mm ²	TFI
16	RT/SW	1mm ²	TFI
17	RT/SW	1mm ²	TFI
18	RT/SW	1mm ²	TFI
19	RT/SW	1mm ²	TFI
20	RT/SW	1mm ²	TFI
21	RT/SW	1mm ²	TFI
22	RT/SW	1mm ²	TFI
23	RT/SW	1mm ²	TFI
24	RT/SW	1mm ²	TFI
25	RT/SW	1mm ²	TFI
26	RT/SW	1mm ²	TFI
27	RT/SW	1mm ²	TFI

CONFIDENTIAL

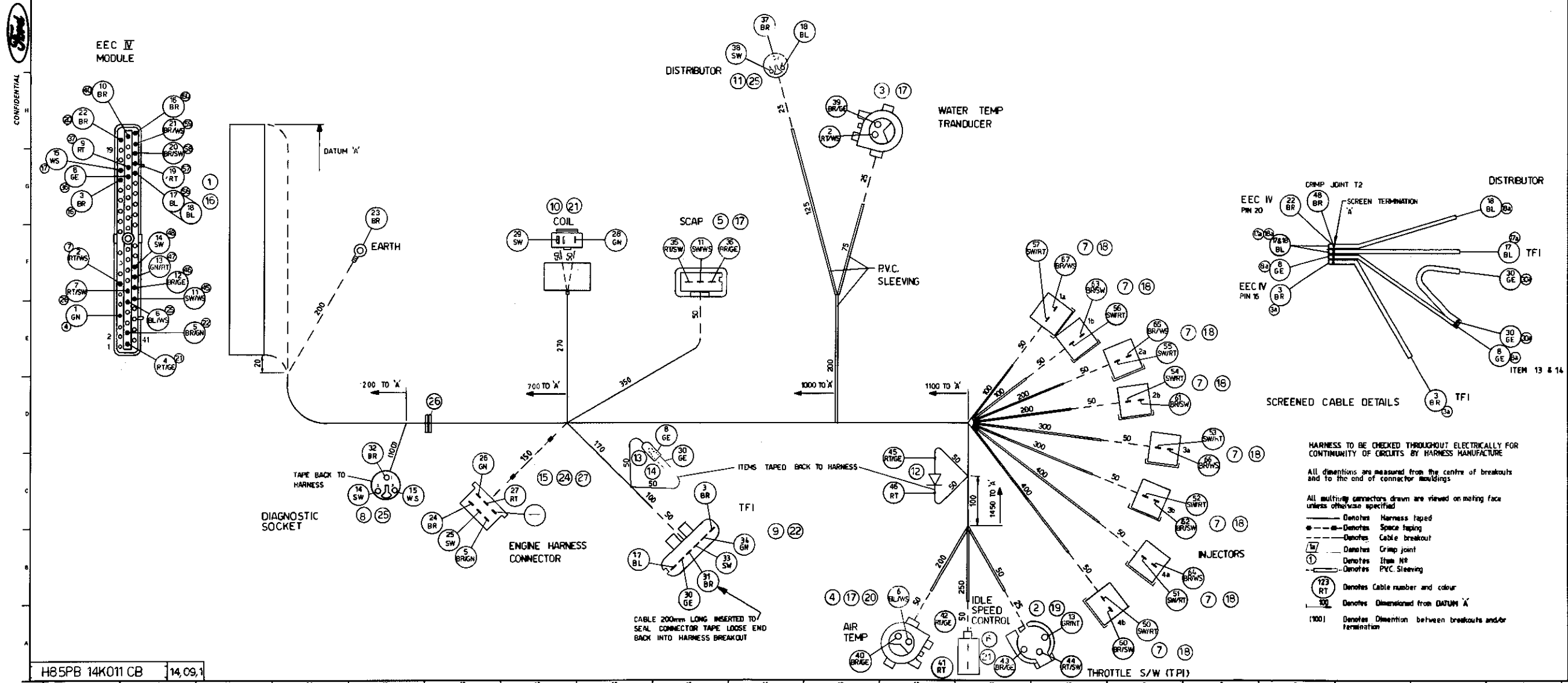

H85PB 14K011 CB 14.09.1

ISSUE 1

WIRING ASSY - ENGINE MANAGEMENT HARNESS RS200 SECTION 2A - 11

WWW.RS200.ORG

DATE	LET	REVISIONS	REL. NR.	DR.	CK.	APP.
20.8.86		T.F.I. REWIRED			T.B.	

SUBJECT TO CERTIFICATION / HOMOLOGATION
 GENEHMIGUNGSPFLICHTIG / HOMOLOGIERUNG

YES NO
 JA NEIN

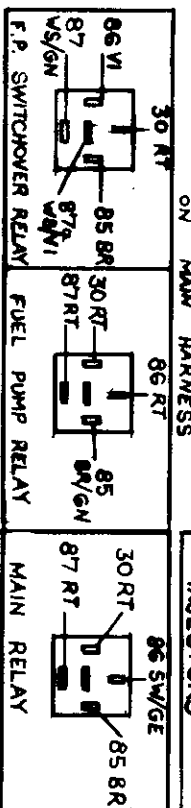
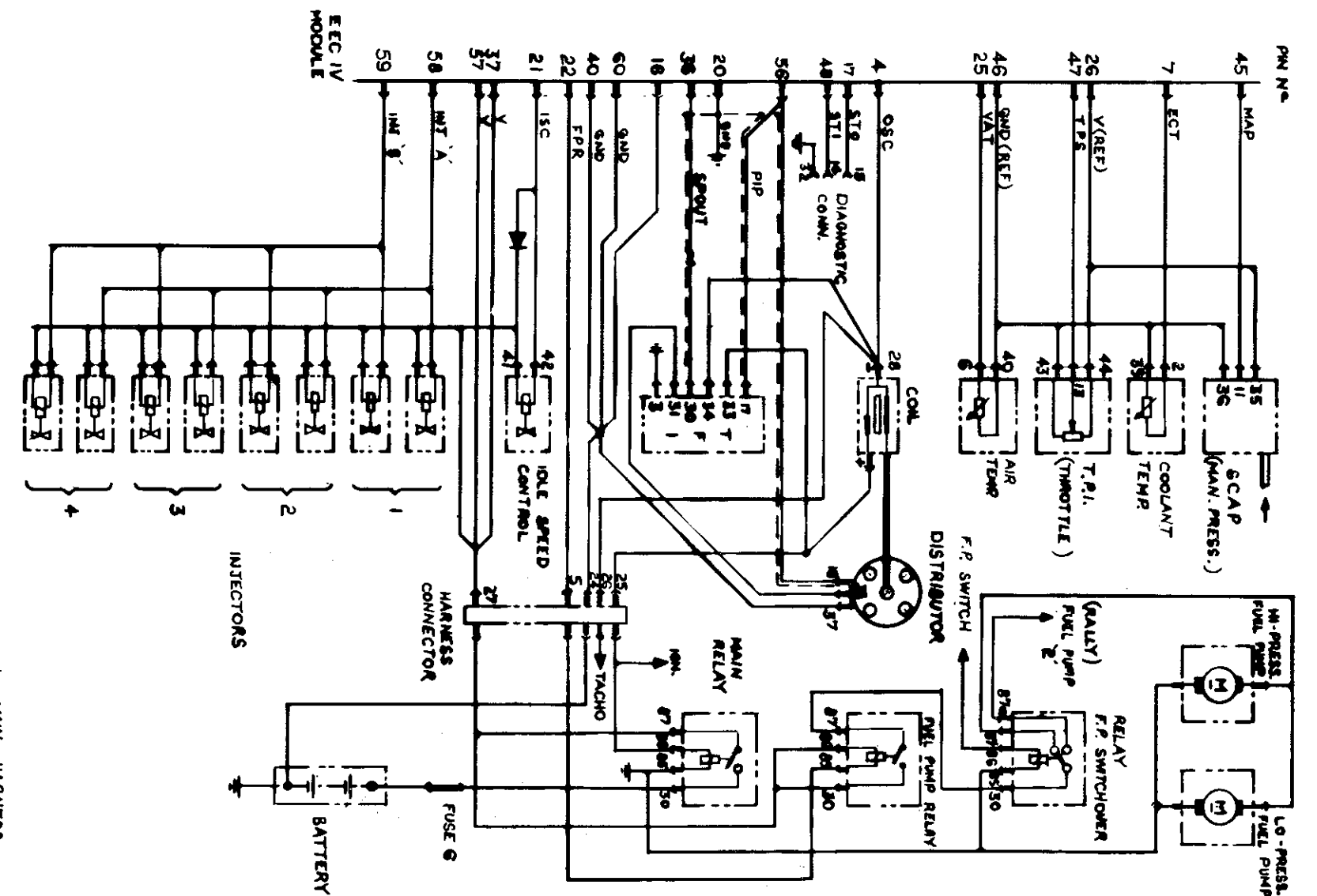

DIAGNOSTIC CONN.	32 BR 14 SW 15 WS
DISTRIBUTOR	37 BR 38 SW 18 BL
AIR TEMP.	40 BR/GE 5 BL/WS
WATER TEMP.	2 RT/WS 39 BR/OE
T.P.I.	43 BR/GE 13 GR/RT 44 RT/SW
SCAP	35 RT/SW 36 SW/WS 36/GE
T.F.I.	3 34 4 33 5 31 6 30 7 17 8 6W 9 5W 10 SW 11 GE 12 BL
COIL	42 RT/GE 41 RT 29 SW 28 GN
INJECTORS	27 RT 25 SW 24 BR 5 BR/GN 6 GN 26 GN
MAIN HARNESS COMM.	RT/SW INT'X BR/WS INT' B' BR/SW

REFERENCES

DR. T. BRADLEY	DATE 20.8.86	CK.	APP.
NICHT ABMESSEN	MASSTAB	SCALE	DO NOT SCALE
WENN NICHT ANDERS ANGEGEBEN: UNLESS OTHERWISE SPECIFIED.			
3 WINKEL PROJEKTION	3RD ANGLE PROJECTION		
MASSE IN MILLIMETER	DIMENSIONS IN MILLIMETRES		
ABMESSUNGEN ±	DIMENSIONS ±		
WINKEL ±	ANGLES		

WERKSTOFF/MATERIAL

OBERFLAECHE/FINISH

MUSS UEBEREINSTIMMEN MIT/MUST CONFORM TO/ENG. SPEC. NR.

TELNAME

PART NAME
WIRING DIAGRAM - ENGINE MANAGEMENT

TEILNUMMER/PART NR.
H85PB 14K011 CC

VERTRAULICH
CONFIDENTIAL



WWW.RS200.ORG

Index sheet listing the Following:**a) Key to cable colour code****b) Cable colour, size and termination points****NB Cable reference numbers are as shown in large circles on main harness diagrams.**

No.	CABLE		TERMINATION	TERMINATION
	COLOUR	SIZE (mm)	A	B
1	RT	2.50	Relay 1 (30)	Crimp Joint 1 (Batt)
2	WS	2.50	Relay 1 (87)	Fuse 15b
3	WS	0.75	Relay 1 (86)	Column S/W
4	BR	0.75	Relay 1 (85)	Relay 2 (85) –ve Bus
5	RT	2.50	Relay 2 (30)	Crimp Joint 1 (Batt)
6	GE	2.00	Relay 2 (87)	Fuse 17b
7	GE	0.75	Relay 2 (86)	Column S/W
8	–	–	–ve Busbar (85)	–ve Busbar (85)
9	RT	2.50	Relay 3 (30)	Crimp Joint 1 (Batt)
10	BL/GE	2.00	Relay 3 (87)	Fuse 9b
11	BL/GE	0.75	Relay 3 (86)	Spotlamp S/W
12	BR	1.00	Relay 3 (85)	Relay 11 (85)
13	RT	2.50	Relay 4 (30)	Crimp Joint 1 (Batt)
14	RT/GE	2.00	Relay 4 (87)	Fuse 11b
15	RT/GE	0.75	Relay 4 (86)	Front Fog S/W
16	BR	1.00	Relay 4 (85)	Crimp Joint 2b (GND)
17	RT	2.50	Relay 5 (30)	Crimp Joint 1 (Batt)
18	VI/GE	2.00	Relay 5 (87)	Fuse 13b
19	VI/GE	0.75	Relay 5 (86)	Long Range S/W
20	–	–	–ve Busbar (85)	–ve Busbar (85)
21	RT	2.50	Relay 6 (30)	Crimp Joint 1 (Batt)
22	SW/RT	2.00	Relay 6 (87)	Fuse 22b
23	BR/SW	0.75	Relay 6 (86)	Rad Fan Switch
24	–	–	–ve Busbar (85)	–ve Busbar (85)
25	–	–	–ve Busbar (85)	–ve Busbar (85)
26	SW/RT	1.00	Relay 7 (49)	Column S/W Wiper
27	SW/GN/WS	1.00	Relay 7 (49a)	Column S/W Wiper
28	–	–	–ve Busbar (31)	–ve Busbar
29	BR/SW	1.00	Relay 8 (31b1)	Crimp Joint 12 (Wiper)
30	BR/GE	1.00	Relay 8 (31b2)	Column S/W LTS/Wiper
31	GN/SW	1.00	Relay 8 (54)	Column S/W LTS/Wiper
32	SW/GE	1.00	Relay 8 (P)	Wiper Delay Rheostat
33	RT	3.00	Relay 9 (30)	Crimp Joint 1 (Batt)
34	SW/GE	3.00	Relay 9 (87)	Fuse 1b
35	SW/GE	0.75	Relay 9 (86)	Crimp Joint 5a (Ign)
36	–	–	–ve Busbar (85)	–ve Busbar (85)
37	RT	2.00	Relay 10 (30)	Crimp Joint 1 (Batt)
38	RT/GE	2.00	Relay 10 (87)	Fuse 7b
39	RT/GE	0.75	Relay 10 (86)	Column S/W Horn
40	RT/GE	0.75	Relay 10 (86)	Rally Auxiliary Horn
41	–	–	–ve Busbar (85)	–ve Busbar (85)
42	RT	3.00	Relay 11 (30)	Crimp Joint 1 (Batt)
43	WS/SW	2.00	Relay 11 (87)	Heated Front Screen LH
44	WS/SW	2.00	Relay 11 (87)	Heated Front Screen RH
45	WS/SW	0.75	Relay 11 (86)	Heated Front Screen S/W
46	–	–	–ve Busbar (85)	–ve Busbar (85)
47	SW/RT/GE	1.00	Fuse 1a	Fan Speed S/W
48	RT	1.00	Fuse 1a	W/Screen Wash Bottle
49	SW/RT	1.00	Fuse 2a	Stop Light S/W

No.	CABLE		TERMINATION	TERMINATION
	COLOUR	SIZE (mm)	A	B
50	SW/BL	1.00	Fuse 2a	Rev Light S/W HNS
51	-	-	Fuse 2b +ve Busbar (Ign)	
52	SW/VI	1.00	Fuse 3a	Crimp Joint 8 (Wiper)
53	-	-	Fuse 3b +ve Busbar (Ign)	
54	SW	1.00	Fuse 4a	Column S/W (Ign)
55	SW/GE	1.00	Fuse 5a	Crimp Joint 4a
56	-	-	Fuse 5b +ve Busbar (Ign)	
57	RT	2.50	Fuse 6a	Main Engine Relay (30)
58	RT	2.50	Fuse 6b	Crimp Joint 1
59	RT/GE	2.00	Fuse 7a	Crimp Joint 13
60	BL/GE	1.50	Fuse 8a	Spotlamp LH
61	-	-	Fuse 8b +ve Busbar (Spotlamps)	
62	BL/GE	1.50	Fuse 9a	Spotlamp RH
63	-	-	-	
64	RT/GE	1.50	Fuse 10a	Front Fog Lamps LH
65	-	-	Fuse 10b +ve Busbar (Foglamps)	
66	RT/GE	1.50	Fuse 11a	Front Fog Lamps RH
67	-	-	-	
68	VI/GE	1.50	Fuse 12a	Long Range Lamps RH
69	-	-	Fuse 12b +ve Busbar (Long Range Lamps)	
70	VI/GE	1.50	Fuse 13a	Long Range Lamps LH
71	-	-	-	
72	WS	1.50	Fuse 14a	H/LT Main Beam LH
73	BL/WS	0.75	Fuse 14a	H/LT Main Beam W/LT
74	-	-	Fuse 14b +ve Busbar (Main Beam)	
75	WS	0.75	Fuse 15b	Long Range/Spot S/W's
76	WS	1.50	Fuse 15b	H/LT Main Beam RH
77	GE	1.50	Fuse 16a	H/LT Dip Beam RH
78	-	-	Fuse 16b + VE Busbar (Dip Beam)	
79	GE	1.50	Fuse 17a	H/LT Dip Beam LH
80	-	-	-	
81	GR/SW	1.00	Fuse 18a	Crimp Joint 10
82	GR	1.00	Fuse 18b	Column S/W (Side LTS Feed)
83	GR/RT	1.00	Fuse 19a	Crimp Joint 17
84	GR/RT	1.00	Fuse 19a	Front Lamp Harness
85	GR/RE	1.00	Fuse 19b	Rear Fog S/W
86	BL/RT	2.00	Fuse 20a	Radio Phone
87	-	-	Fuse 20b +ve Busbar (Batt)	
88	RT	1.50	Fuse 21a	Cigar Lighter
89	RT	1.50	Fuse 21a	Interior Lamp Con (Feed)
90	RT	2.50	Fuse 21b	Crimp Joint 1
91	SW/RT	2.00	Fuse 22a	Radiator Fan
92	GR/GN	0.75	Front Fog S/W	Crimp Joint 11b
93	BR	0.75	Front Fog S/W	Crimp Joint 2c
94	GR/GN	0.75	Long Range S/W	Crimp Joint 11b
95	BR	0.75	Long Range S/W	Crimp Joint 2c
96	GN	1.00	Wiper Motor	Column S/W (Wiper)
97	RT	1.00	Wiper Motor	Column S/W (Wiper)
98	SW/VI	1.00	Wiper Motor	Crimp Joint 8
99	BR	1.00	Wiper Motor	Crimp Joint 2f
100	BR/WS	1.00	Column S/W (Wiper)	Crimp Joint 12
101	SW	1.00	Column S/W (Lts/Wiper)	Crimp Joint 4a
102	BR/GE	0.75	Column S/W (Lts/Wiper)	W/Screen Wash Bottle
103	RT	1.50	Column S/W (Lts/Wiper)	Crimp Joint 1

No.	CABLE		TERMINATION	TERMINATION
	COLOUR	SIZE (mm)	A	B
104	BR	0.75	Column S/W (Lts/Wiper)	Crimp Joint 2a
105	BR/GE	0.75	Wiper Delay Rheostat	Crimp Joint 2a
106	GR/GN	0.75	Wiper Delay Rheostat	Crimp Joint 11a
107	SW/VI	1.00	Wiper Delay Rheostat	Crimp Joint 8
108	SW/WS	1.00	Column S/W	Crimp Joint 7a
109	GN/SW	1.00	Column S/W	Crimp Joint 6
110	RT	1.00	Column S/W	Crimp Joint 1
111	RT	7x2.50	+ve Battery Term	Crimp Joint 1
112	SW/BL	1.00	G/Box Rev Lamp S/W	Rear Lamp Harness
113	GR/GN	1.00	Crimp Joint 11a	Crimp Joint 11b
114	SW	2.00	Engine Harness Con	Crimp Joint 5b
115	BR	2.00	Front Lamp Harness RH	Front Chassis (GND)
116	GN/SW	1.00	Front Lamp Harness RH	Crimp Joint 6
117	GR/SW	1.00	Front Lamp Harness LH	Crimp Joint 10
118	BR	2.00	Front Lamp Harness LH	Front Chassis (GND)
119	SW/WS	1.00	Front Lamp Harness LH	Crimp Joint 7a
120	SW/GE	0.75	Int Lamp Harness (Clock)	Crimp Joint 4a
121	GR/SW	0.75	Int Lamp Harness (Clock)	Crimp Joint 10
122	VI	0.75	Fuel C/Over Relay	Fuel C/Over S/W
123	RT/GE	1.50	Horn LH	Crimp Joint 13
124	RT/GE	1.50	Horn RH	Crimp Joint 13
125	BR	1.50	Cigar Lighter	Crimp Joint 2c
126	GR/GN	0.75	Rear Fog S/W	Crimp Joint 11b
127	BR	0.75	Rear Fog S/W	Crimp Joint 2c
128	SW/RT	0.75	Rad Fan Stat S/W	Fuse 2a
129	WS/SW	0.75	Column S/W	Column S/W (LTS/Wiper)
130	BR	2.00	Rad Fan Motor	Front Chassis (GND)
131	BR	2.50	Front Chassis (GND)	Crimp Joint 2b
132	GR/GN	1.00	Crimp Joint 11a	Crimp Joint 11c
133	BR/RT	0.75	Int Lamp Harness	Crimp Joint 9
134	BR/RT	0.75	Door S/W LH	Crimp Joint 9
135	BR/RT	0.75	Door S/W RH	Crimp Joint 9
136	SW/RT	1.00	Fan Ballast Resistor	Fan Speed S/W
137	GN/SW	1.00	Fan Ballast Resistor	Fan Speed S/W
138	SW/GE	1.00	Fan Ballast Resistor	Fan Speed S/W
139	SW	2.50	Ignition S/W	Crimp Joint 5a
140	RT	3.00	Ignition S/W	Crimp Joint 1
141	RT/BL	3.00	Ignition S/W	Starter Solenoid
142	BR	0.75	Fan Speed S/W Illum	Crimp Joint 2c
143	GR/GN	0.75	Fan Speed S/W Illum	Crimp Joint 11b
144	BR	0.75	Panel Lamps Rheostat	Crimp Joint 2a
145	GR/GN	0.75	Panel Lamps Rheostat	Crimp Joint 11a
146	GR/SW	0.75	Panel Lamps Rheostat	Crimp Joint 10
147	GN	1.00	Engine Harness	Tachometer
148	BR	2.00	Engine Harness	Rear Chassis (Ground)
149	SW/GE	1.00	Main Engine Relay	Crimp Joint 5
150	BL/GN	0.75	Rear Aux Harness	Oil Press Gauge
151	BL/GN/BR	0.75	Rear Aux Harness	Oil Press W/LE
152	BL	1.00	Alternator (IND)	Ign W/LT
153	RT/WS	0.75	Water Temp Transducer	Water Temp Gauge
154	GE/BL	0.75	Fuel Press Transducer	Fuel Press Gauge
155	BR	0.75	Heater Control Illum	Crimp Joint 2d
156	GR/GN	0.75	Heater Control Illum	Crimp Joint 11d

No.	CABLE		TERMINATION	TERMINATION
	COLOUR	SIZE (mm)	A	B
157	BL/SW	0.75	Fuel Tank Harness	Fuel Level Gauge
158	BR	0.75	Crimp Joint 2d	Fuel Level Gauge
159	WS	0.75	Spotlamp S/W	Long Range Lamp S/W
160	GR/GN	1.00	Crimp Joint 11 a	Crimp Joint 11 d
161	GR/GN	0.75	Fuel Press Illum	Crimp Joint 11 d
162	GR/GN	0.75	Fuel Level Illum	Crimp Joint 11 d
163	GR/GN	0.75	Voltmeter Illum	Crimp Joint 11 d
164	GR/GN	0.75	Vacuum/Boost Illum	Crimp Joint 11 d
165	GR/GN	0.75	Spot Lamp S/W Illum	Crimp Joint 11 b
166	GR/GN	0.75	Cigar Lighter Illum	Crimp Joint 11 b
167	GR/GN	0.75	Speedo Illum	Crimp Joint 11 c
168	GR/GN	0.75	Spedo Illum	Crimp Joint 11 c
169	GR/GN	0.75	Tacho Illum	Crimp Joint 11 c
170	GR/GN	0.75	Oil Press Illum	Crimp Joint 11 c
171	GR/GN	0.75	Water Temp Illum	Crimp Joint 11 c
172	SW/GE	2.00	Crimp Joint 4b	Crimp Joint 4a
173	SW/GE	0.75	Fuel Pressure Gauge	Crimp Joint 4b
174	SW/GE	0.75	Fuel Level Gauge	Crimp Joint 4b
175	SW/GE	0.75	Voltmeter	Crimp Joint 4b
176	SW/GE	0.75	Heated Front Screen S/W	Crimp Joint 4b
177	SW/GE	0.75	Fuel Change Over S/W	Crimp Joint 4b
178	SW/GE	1.00	Crimp Joint 4a	Crimp Joint 4c
179	SW/GE	0.75	Brake Fail W/LT	Crimp Joint 4c
180	SW/GE	0.75	Transfer Box W/LT	Crimp Joint 4c
181	SW/GE	0.75	Tachometer	Crimp Joint 4c
182	SW/GE	0.75	Oil Press W/LT	Crimp Joint 4c
183	SW/GE	0.75	Oil Press Gauge	Crimp Joint 4c
184	SW/GE	0.75	Ignition W/LT	Crimp Joint 4c
185	SW/GE	0.75	Water Temp Gauge	Crimp Joint 4c
186	BR/SW	0.75	Column S/W	Crimp Joint 4a
187	SW/GE	2.00	Rally Aux Feed	Crimp Joint 4a
188	GR/GN	0.75	Tachometer Illum	Crimp Joint 11 c
189	BR	1.00	Crimp Joint 2c	Crimp Joint 2b
190	BR	0.75	Speedometer Illum	Crimp Joint 2e
191	BR	0.75	Speedometer Illum	Crimp Joint 2e
192	BR	0.75	Tachometer	Crimp Joint 2e
193	BR	0.75	Oil Pressure Illum	Crimp Joint 2e
194	BR	2.50	Crimp Joint 2b	Crimp Joint 2a
195	BR	0.75	Oil Pressure Gauge	Crimp Joint 2e
196	BR	0.75	Water Temp Illum	Crimp Joint 2e
197	BR	0.75	Water Temp Gauge	Crimp Joint 2e
198	BR	0.75	High Beam W/LT	Crimp Joint 2e
199	BR	1.00	Crimp Joint 2a	Crimp Joint 2e
200	BR	0.75	Fuel Press Gauge	Crimp Joint 2d
201	BR	0.75	Fuel Press Illum	Crimp Joint 2d
202	BR	0.75	Fuel Level Illum	Crimp Joint 2d
203	BR	0.75	Voltmeter	Crimp Joint 2d
204	BR	1.00	Crimp Joint 2b	Crimp Joint 2d
205	BR	0.75	Voltmeter	Crimp Joint 2d
206	BR	0.75	Vacuum/Boost	Crimp Joint 2d
207	BR	0.75	Spotlamp S/W	Crimp Joint 2c
208	BR	0.75	H/Brake S/W	Crimp Joint 2b
209	BR	0.75	Door S/W RH	Crimp Joint 2a

WWW.RS200.ORG

No.	CABLE		TERMINATION	TERMINATION
	COLOUR	SIZE (mm)	A	B
210	BR	0.75	Door S/W LH	Crimp Joint 2b
211	SW/GE	2.50	Crimp Joint 5a	Crimp Joint 5a
212	BR	0.75	Brake Fluid Level S/W	Crimp Joint 2f
213	BR	0.75	Brake Fluid Level S/W	Crimp Joint 2f
214	WS/RT	0.75	Transfer Box W/LT	Transfer Box S/W
215	SW/WS	0.75	Direction Ind W/LT	Crimp Joint 7a
216	GN/SW	0.75	Direction Ind W/LT	Crimp Joint 6
217	BR/WS	1.00	Wiper Motor	Crimp Joint 12
218	SW/VI	1.00	Column S/W (LTS/Wiper)	Crimp Joint 8
219	GR/SW	0.75	Front Fog S/W	Crimp Joint 10
220	BR	2.00	Rear Lamp Harness	Crimp Joint 3a
221	SW/WS	1.00	Rear Lamp Harness	Crimp Joint 7b
222	GN/SW	1.00	Rear Lamp Harness	Crimp Joint 6
223	GR/GE	1.00	Rear Lamp Harness	Rear Fog S/W
224	GR/SW	1.00	Rear Lamp Harness	Crimp Joint 10
225	SW/RT	1.00	Rear Lamp Harness	Stop Lamp S/W
226	BR	2.00	Front Chassis Ground	Crimp Joint 14
227	BR	1.50	Horn LH	Crimp Joint 14
228	BR	1.50	Horn RH	Crimp Joint 14
229	BR/GN	0.75	Brake Fail W/LT	Crimp Joint 16
230	BR/GN	0.75	H/Brake S/W	Crimp Joint 16
231	BR/GN	0.75	Brake Fluid Levels S/W	Crimp Joint 16
232	BR/GN	0.75	Brake Fluid Levels S/W	Crimp Joint 16
233	BR	2.00	Long Range Lamps	Front Chassis Ground
234	BR	2.00	Spot Lamps	Front Chassis Ground
235	RT	2.00	Rally Aux Feed	Crimp Joint 1
236	BR	2.00	Rally Aux Ground	Crimp Joint 2b
237	GR/RT	0.75	Rear Aux Harness	Engine Bay Lamp
238	SW/WS	1.00	Rear Aux Harness	Crimp Joint 7b
239	GR/RT	1.00	Rear Aux Harness	Crimp Joint 17
240	BR	1.00	Fuel Tank Harness	Crimp Joint 3a
241	RT	1.50	Fuel Pump Relay	Fuel C/Over Relay
250	BR	3.00	Rear Chassis Ground	Crimp Joint 3a
251	BR	1.50	Crimp Joint 3b	Crimp Joint 3a
252	BR	1.50	High Press Fuel Pump	Crimp Joint 3a
253	BR	1.50	High Press Fuel Pump	Crimp Joint 3a
254	BR	1.50	Low Press Fuel Pump	Crimp Joint 3a
255	BR	0.75	Fuel Press Transducer	Crimp Joint 3b
256	BR	0.75	Main Engine Relay	Crimp Joint 3b
257	BR/GN	0.75	Fuel Pump Relay	Engine Harness Con
258	BR	0.75	Fuel Pump C/Over Relay	Crimp Joint 3b
259	BR	2.00	Rear Aux Harness	Crimp Joint 3a
260	WS/GN	1.50	Fuel Pump C/Over Relay	High Pressure Fuel Pump
261	WS/GN	1.50	Fuel Pump C/Over Relay	Low Pressure Fuel Pump
262	WS/VI	1.50	Fuel Pump C/Over Relay	Low Pressure Fuel Pump
263	WS/VI	1.50	Fuel Pump C/Over Relay	High Pressure Fuel Pump
264	RT	2.50	Main Engine Relay	Crimp Joint 15
265	RT	2.00	Fuel Pump Relay (30)	Crimp Joint 15
266	RT	0.75	Fuel Pump Relay (86)	Crimp Joint 15
267	RT	2.00	Engine Harness Connector	Crimp Joint 15
268	BR	1.00	Interior Lamp Harness	Crimp Joint 3a
269	SW/WS	1.00	Crimp Joint 7a	Crimp Joint 7b
270	GR/RT	1.00	Rear Lamp Harness	Crimp Joint 17

COLOUR CODE RS200

SW - BLACK
WS - WHITE
GN - GREEN
GE - YELLOW
BR - BROWN
RT - RED
BL - BLUE
VI - VIOLET

WWW.RS200.ORG

Index sheet listing electrical components.**NB. Component reference numbers are as shown in small circles on main harness diagrams**

ITEM	DESCRIPTION
1	Fuse Box & Relay Centre
2	Switch Moulding 6 Way - Spotlight
3	Switch Moulding 6 Way - Front Fog
4	Switch Moulding 6 Way - Long Range
5	Moulding 5 Way - Wiper Motor
6	Moulding 4 Way - Column S/W
7	Moulding 8 Way - Column S/W
8	Switch Moulding 6 Way - Wiper Delay
9	Moulding 10 Way - Column S/W
10	Moulding 2 Way - Washer Bottle
11	Moulding 2 Way - Spotlamp S/W
12	Moulding 2 Way - Gearbox Harness
13	Moulding 4 Way - Column S/W
14	Connector 1 Way - L.H. Horn
15	Moulding 3 Way - Long Range Lamps
16A	Pin Moulding 2 Way - R.H. Front Harness
16B	Pin Moulding 4 Way - R.H. Front Harness
17	Socket Moulding 5 Way - CTSY Lamp Harness
18	Moulding 8 Way - Rear Lamp Harness
19	Switch Moulding 6 Way - Rear Fog Lamp
20	Moulding 2 Way - Rad Fan
21	Connector 2 Way - R.H. Horn
22	Moulding 2 Way - Rad Fan S/W
23	-
24	Moulding 3 Way - Heater Ballast Resistor
25	Moulding 4 Way - Ignition S/W
26	Bulb Holder - Heater Control
27	Switch Moulding 6 Way - Panel Dimmer
28	Moulding 6 Way - Engine Harness
29	Moulding 6 Way - Fan Speed Switch
30	Moulding 2 Way - Oil W/LT
31	Moulding 2 Way - Ignition W/LT
32	Moulding 2 Way - Speedometer Illum
33	Moulding 2 Way - Speedometer Illum
34	Moulding 2 Way - High Beam W/T
35	Moulding 2 Way - Direction Indicator W/LT
36	Moulding 2 Way - Brake W/LT
37	Moulding 3 Way - Water Temp Gauge
38	Moulding 3 Way - Fuel Pressure Gauge
39	Moulding 3 Way - Fuel Content Gauge
40	Moulding 3 Way - Oil Pressure Gauge
41	Connector 1 Way - Fuel Change Over
42	Connector 1 Way - LH Door S/W
43	Connector 1 Way - RH Door S/W
44A	Moulding 2 Way - LH Front Harness
44B	Moulding 4 Way - LH Front Harness
45	Ring Terminal - Fuel Press Transducer
46	Connector 1 Way - Fuel Gauge Illum
47	Moulding 2 Way - Voltmeter
48	-
49	Connector 1 Way - Fuel Press Illum
50	Connector 1 Way - Fuel Press Illum

ITEM	DESCRIPTION
51	Connector 1 Way - Heated Front Window
52	Ring Terminal - Main Battery Term
53	Ring Terminal - Chassis Earth Front
54	Ring Terminal - Chassis Earth Front
55	-
56	Moulding 2 Way - Fuel Tank Harness
57	Connector 2 Way Starter Mtr Solenoid
58	-
59	-
60	Ring Terminal - Alternator W/LT
61	Connector 1 Way - Water Temp Transducer
62	Moulding 3 Way - Spotlamps
63	Connector 1 Way - Boost Gauge Illum
64	-
65	-
66	Moulding 2 Way - Transfer Box W/LT
67	-
68	Ring Terminal - Handbrake S/W
69	Connector 1 Way - Tachometer Illum
70	Connector 1 Way - Oil Press Illum
71	-
72	Connector 1 Way - Radio Intercom
73	Connector 1 Way - Cigar Lighter
74	Connector 1 Way - Tachometer
75	Connector 1 Way - Tachometer
76	Connector 1 Way - Tachometer
77	Connector 1 Way - Voltmeter Illum
78	Ring Terminal - Voltmeter Illum
79	Ring Terminal - Fuel Gauge Illum
80	-
81	Connector 1 Way - Oil Press Illum
82	Connector 1 Way - Water Temp Illum
83	Connector 1 Way - Water Temp Illum
84	Connector 1 Way - Tachometer Illum
85	Ring Terminal - Rear Chassis Ground
86	Connector 1 Way - Handbrake S/W
87	Connector 1 Way - Transfer Box W/LT
88	-
89	Moulding 4 Way - Rally Aux Feed
90	Connector 1 Way - Heated Front Screen
91	-
92	Connector 1 Way - Brake Fluid S/W
93	Connector 1 Way - Brake Fluid S/W
94	Connector 1 Way - Brake Fluid S/W
95	Connector 1 Way - Brake Fluid S/W
96	-
97	-
98	-
99	Connector 1 Way - LH Door S/W
100	Connector 1 Way - RH Door S/W
101	Ring Terminal - Boost Gauge Illum
102	Connector 1 Way - Heated Front Screen S/W
103	Connector 1 Way - Fuel Change Over S/W

ITEM	DESCRIPTION
104	Connector 1 Way - Cigar Lighter Ground
105	Connector 1 Way - Cigar Lighter Illum
106	Ring Terminal - Horn LH
107	Ring Terminal - Horn RH
108	Ring Terminal - Fuel Press Transducer
109	Ring Terminal - High Press Fuel Pump
110	Ring Terminal - High Press Fuel Pump
111	Ring Terminal - High Press Fuel Pump
112	Ring Terminal - High Press Fuel Pump
113	Ring Terminal - Low Press Fuel Pump
114	Connector 1 Way - Low Press Fuel Pump
115	Connector 1 Way - Low Press Fuel Pump
116	Relay Moulding - Main Engine Relay - Green
117	Relay Moulding - Fuel Pump Relay - Yellow
118	Relay Moulding - Fuel Pump Change Over Relay - Blue
119	Grommet
120	Grommet
121	Cover - Brake Fluid Tops

WWW.RS200.ORG

KNOW YOUR CAR

02

WWW.RS200.ORG

Index

	Page
Keys	2
Starter Switch/steering lock	2
Vehicle identification plate	3
Engine and transmission numbers	3
Interior equipment and controls	4-7
Instruments, warning lights	8-13
Radio installation	14
Multi function clock	15-16
Heating and ventilation	17-19
Windows, doors and locks	20

Keys

Your RS200 is provided with two examples of a single key.

This operates the starter switch/steering column lock, on the steering column, both the doors of the vehicle, and the locking fuel filler cap.

There are no external locks to the front or rear body section latches.

To ensure speedy replacement, in case you lose the keys, it is recommended that the key number tag is kept in a safe place, separate from the key itself.

Starter Switch/Steering Lock

Four positions are marked on the lock:

⚠ WARNING—Never allow the vehicle to free wheel with the ignition switched off. None of the ignition related systems will be operating, such as the direction indicators and brake lights. Additionally the steering lock could engage in position **0**.

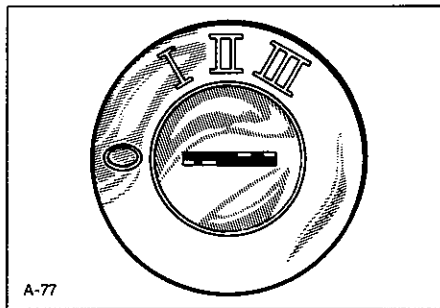

Key position 0:

The ignition is switched off and the steering is locked.

When unlocking from position **0**, push the key in the lock and turn and at the same time move the steering wheel to ease the pressure on the locking device. After a journey, remove the key and turn the steering wheel until lock is engaged.

⚠ WARNING—Do not return the key to position **0** when the vehicle is moving.

Key position I.

The steering is unlocked.

The ignition remains off but the radio (if fitted) and digital clock may be switched on.

Key position II.

The ignition and all circuits are switched on for driving.

⚠ WARNING—If the vehicle is being towed, the key must be in this position.

Key position III.

The starter motor is operated.

If the engine does not start immediately, the key must be returned to position **I** before the starter motor can be operated again.

Vehicle Identification Plate

The vehicle identification plate is located on a panel behind the right front wheel, on the passenger bulkhead. The number is also stamped along the lower edge of this panel.

The plate is stamped with a seventeen digit 'Vehicle identification Number' which is unique to your vehicle. This plate identifies the vehicle type and components fitted.

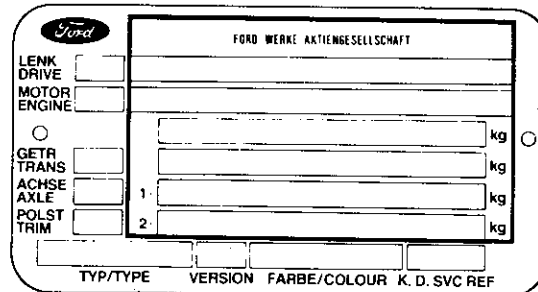

A-78

This is a typical Vehicle Identification Number for your car:

SFACXXBJ2CGL00080

– which indicates that this was the eightieth car made. Throughout the production run of the RS200, only the last two letters and the final three numbers vary from car to car; each car has a unique number.

Engine Identification Number

This is stamped on a boss cast on to the cylinder head water gallery, on the exhaust side of the engine. The numbering sequence is prefixed by the code: BDT2, followed by the number of the actual engine used. In all probability, this number will not coincide with the chassis number of the vehicle itself.

Main Transmission (Transaxle) Identification Number

This is stamped on a tag located under a bolt on the left side of the casing. The numbering sequence is prefixed by the code: B200, followed by the number of the transmission itself. In all probability, this number will not coincide with the chassis number of the vehicle itself.

On the same tag are the Serial Numbers of the centre and front viscous coupling limited-slip differentials. The VC Part Number is either AF41114 (Road-car specification) or BF41114 (Rally-car specification), accompanied by the serial number itself.

The transaxle dipstick is positioned close to the front differential, and has maximum and minimum markings.

Rear Final Drive Identification Number

This is stamped on a tag located under a bolt on the rear cover of the casing. The numbering sequence is prefixed by the code: B200, followed by the number of the unit itself. In all probability, this number will not coincide with the chassis number of the vehicle itself, nor with the number of the main transaxle on the same car.

On the same tag is the Serial Number of the viscous coupling limited-slip differential. The VC Part Number is either AF41039 (Road-car specification) or BF41039 (Rally-car specification), accompanied by the serial number itself.

There is a rear final drive dipstick in the casing, with maximum and minimum markings.

INTERIOR EQUIPMENT AND CONTROLS

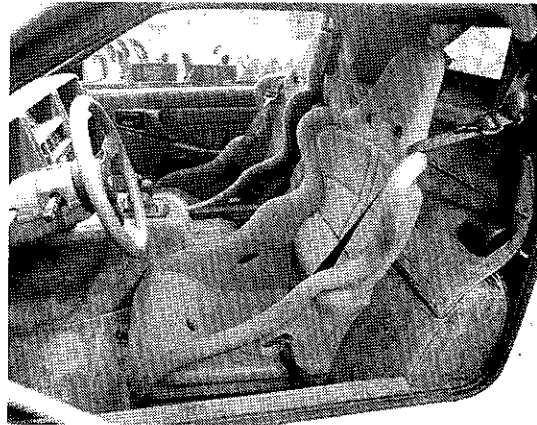
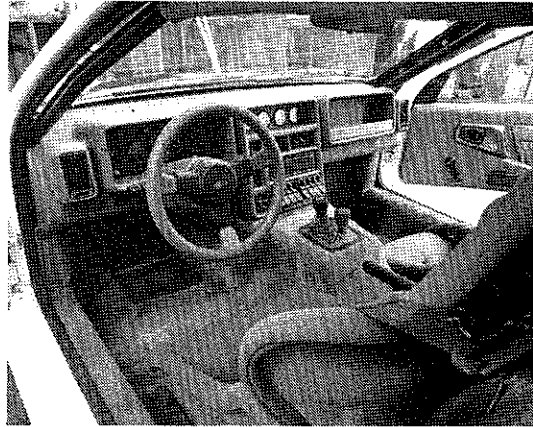

A) Inertia reel seat belts

To wear, pull the seat belt steadily out of the reel, using the tongue, and push the tongue into the buckle until a click is heard. To release the belt, push the red button on the buckle.

B) Seat slide lever

If you wish to change the position of the seat, pull the lever located at the front base of the seat sideways, and slide the seat forwards, or backwards, to the required position. Release the lever, and ensure that the locking mechanism has engaged by gently rocking the seat.

C) Glove/oddment recess

Ahead of the passenger's seating position, there is a receptacle, intended to store small items. The vehicle's central electrical fuse and relay box is located behind this recess.

D) Head restraints

Non-adjustable head restraints are an important design feature of the competition seats fitted to the car.

E) Rear Body Section Release Lever

This is located on the rear passenger compartment bulkhead, behind the left side seat backrest. To release the body section lock, which is in the extreme tail, pull the lever forwards, towards the front of the car.

Reach under the extreme tail of the car, below the number plate illumination lamps, and lift up the body section; the gas-filled struts will assist this operation. Support the body section by swinging up the gas strut prop, to ensure that it is positively located.

Before closing down the rear body section, make sure that the strut prop is securely stowed. Lower the body, then finally allow it to drop the last few inches into its closed and locked position. Always ensure that it is fully latched.



F) Sun Vizors

G) Dipping rear view mirror

To reduce glare from the lights of following vehicles, the rear-view mirror may be dipped by pulling back the lever under the mirror lens.

H) Front body section release lever

Pull the lever under the steering column shroud downwards. This releases the latch. Move outside the car, reach under the rear edge of the front panel, close to the windscreen surround moulding, check that the mechanism has fully opened, then lift up the panel towards the front of the car.

To close the section, pull it past the resistance of the over-centre latch, lower it towards the windscreen, and allow it to drop the last few inches to its closed position. Before driving off, check that the latch has properly engaged. Check that the release lever under the column shroud has returned to its normal position.

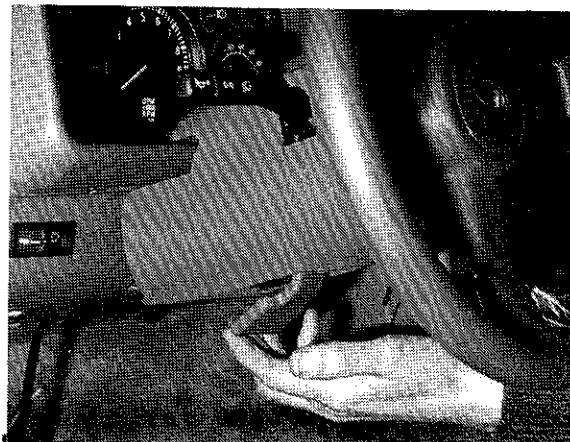

J) Door-mounted mirrors

The door mirrors on each side of the car may be adjusted from the inside of the vehicle, by moving the joy stick mounted in the door panel.

L) Transmission mode changes

The Mode Change lever has forward, central, and rearward positions; if installed, changes may be made, on the move, while depressing the clutch pedal fully.

In the forward position, the transmission is in four-wheel-drive/locked-differential mode, in the central position in four-wheel-drive/viscous differential mode, while in the rearward position, only the rear wheels are driven. Normally, the RS200 should always be driven in four wheel drive, with viscous differential.

Gear changing

All forward gears of the five-speed transmission have synchromesh. Movement of the lever is biased towards the 3rd/4th gear plane.

⚠ WARNING—Care should be taken when changing from 5th to 4th gear that no undue side pressure is applied to the gear lever, otherwise there is a possibility of accidentally selecting 2nd gear.

Reverse gear is selected by moving the gear lever fully to the right against the heavy secondary spring, then moving it backwards. It is not necessary to lift, or depress, the gear knob when carrying out this move. The detent has been provided to ensure that reverse is not accidentally engaged when making a quick down change from fifth to fourth gear. To avoid noisy gear engagement, depress clutch pedal fully when the engine is at idling speed and then wait a few seconds before selecting reverse gear.

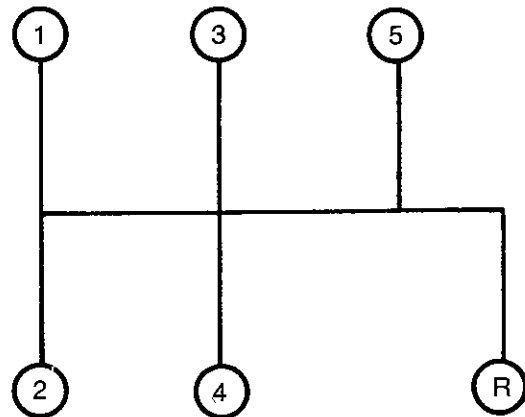
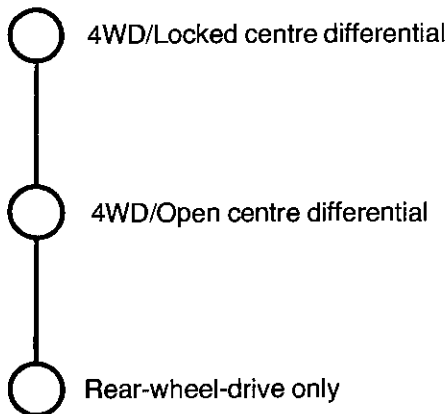

N) Interior lights

The interior lights, above the windscreen and above the rear window, have three switch positions:

- Light on when a door is open
- Off
- Light on all the time



O) Reading lamps/Map lamps

The adjustable reading lamps are located in the roof console over the rear window, adjacent to rocker switches controlling them.

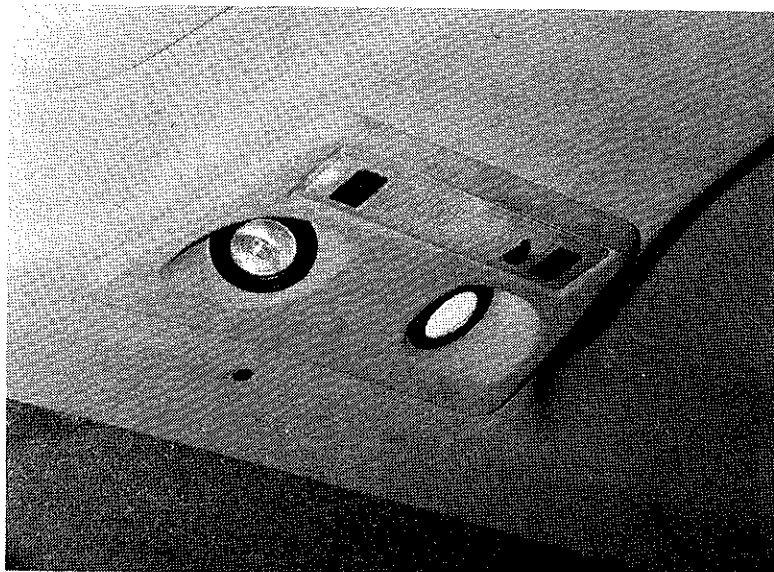

INSTRUMENT PANEL (RIGHT HAND DRIVE)

1. Fuel contents gauge
2. Fuel pressure gauge
3. Voltmeter/battery condition meter
4. Turbocharger boost gauge
5. Speedometer
6. Handbrake/brake fluid level warning light
7. Tachometer
8. Oil pressure warning light
9. Oil pressure gauge
10. Ignition warning light
11. Water temperature gauge
- 12.)
- 13.) Spare switches, for extra electrical circuits (at owner's
- 14.) discretion)
- 15.)
16. Provision for mounting radio/cassette receiver
17. Fog/Spot lamp switch
18. Long range lamp switch (lamp not fitted on standard car)
19. Twin front fog lamps switch
20. Rear fog warning lamp switch
21. Trip reset knob
22. Instrument illumination control
23. Transfer box temperature warning light
24. Hazard flasher switch
25. Direction indicator warning light
26. Variable intermittent wiper control
27. Main beam warning light

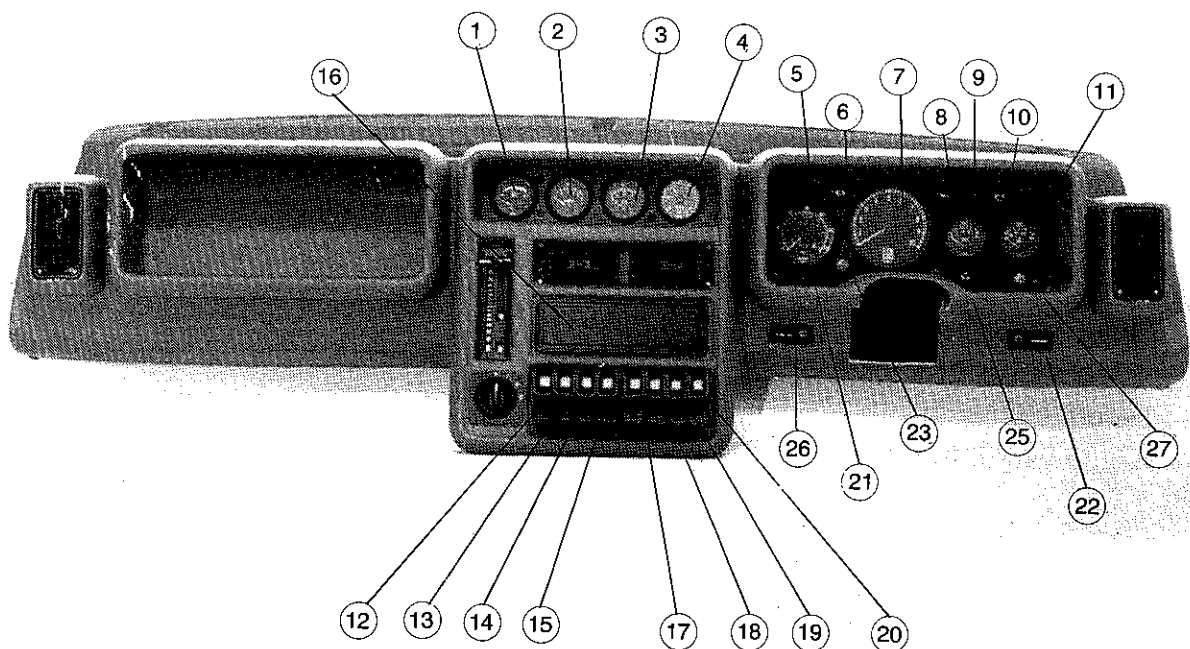

WWW.RS200.ORG

INSTRUMENT PANEL (LEFT HAND DRIVE)

1. Water temperature gauge
2. Ignition warning light
3. Oil pressure gauge
4. Oil pressure warning light
5. Tachometer
6. Handbrake/brake balance warning light
7. Speedometer
8. Fuel contents gauge
9. Fuel pressure gauge
10. Voltmeter/battery condition meter
11. Turbocharger boost gauge
12. Main beam warning light
13. Variable intermittent wiper control
14. Direction indicator warning light
15. Hazard flasher switch
16. Transfer box temperature warning light
17. Instrument illumination control
18. Trip reset button
- 19.)
- 20.) Spare switches, for extra electrical circuits (at owner's
- 21.) discretion)
- 22.)
23. Provision for mounting radio/cassette receiver
24. Long range lamp switch (lamp not fitted on standard car)
25. Spot lamp switch (lamp not fitted on standard car)
26. Twin front fog lamps switch
27. Rear fog warning lamp switch

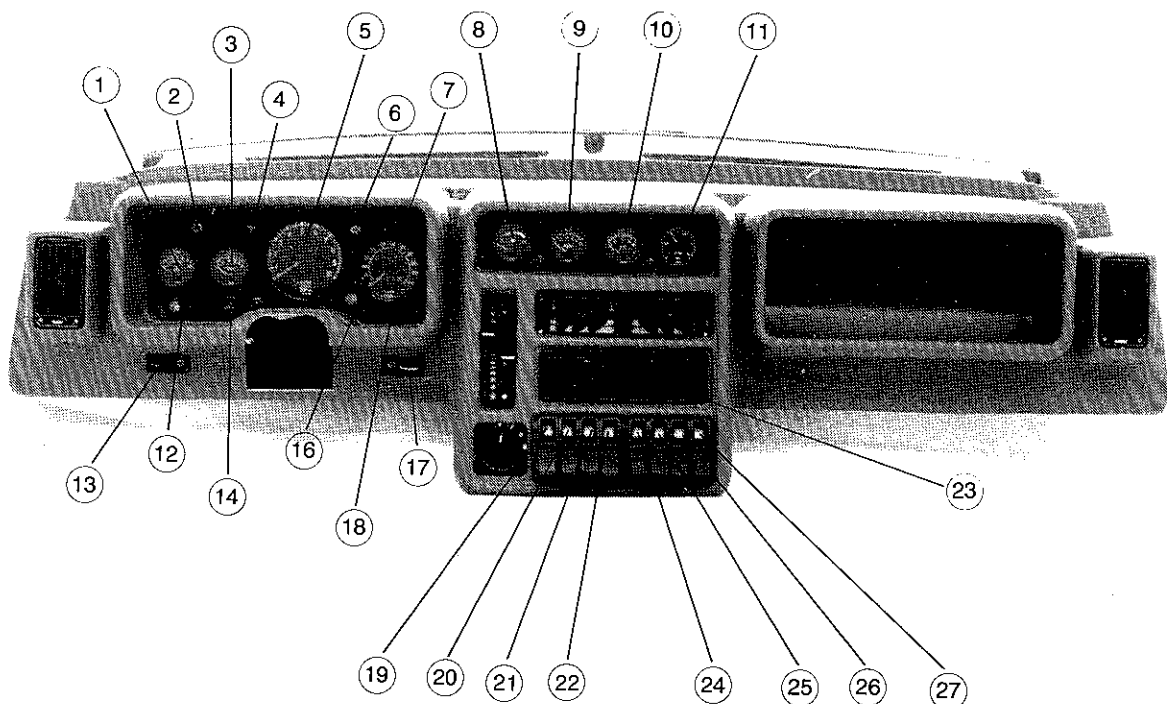

PANEL SWITCHES

NOTE: In the instrument or switch functions described below, the reference number in brackets refers to the left-hand-drive model instrument diagram. Open numbers refer to the right-hand-drive model.

An amber colour segment is exposed to give a visual indication that switches are ON. When the vehicle exterior lights are switched on, the rocker switches emit a low-intensity light, enabling the driver to locate them in the dark. In the ON position, the symbol above the switch is additionally illuminated and appears brighter, to remind the driver that the switch is ON.

11 (1) Water temperature gauge

With the ignition switched on, this indicates the temperature of the engine coolant. During normal engine operation, the needle will register between 70 and 90 degrees Celcius. Dependent on road, vehicle, and ambient conditions, the needle may rise to indicate more than 100 degrees C. If this occurs for any reason, stop the car *as soon as it is safe to do so*, switch off the engine, and investigate. (See WHAT TO DO IN AN EMERGENCY). Do not re-start the engine until the problem has been rectified.

Note: The cooling radiator is in the nose of the car, but the header tank is mounted on the tubular cross-member, behind the engine, in the tail of the car. Note that local cylinder head temperatures may be higher than those shown on the gauge.

10 (2) Ignition warning light

This lights up when the ignition switch is turned ON, but extinguishes as soon as the engine speed rises above a fast idle. Should the light illuminate while you are driving, this indicates that the battery is no longer being charged. The alternator drive belt may be loose, or even broken. Pull of the road immediately, stop, tighten or replace the belt (See WHAT TO DO IN AN EMERGENCY). If the cause is clearly not due to the malfunction of this belt, drive to the nearest FORD dealer, for attention, after switching off all unnecessary electrical equipment, so as to prevent excessive discharge of the battery.

9 (3) Oil Pressure Gauge

This gauge will give a high, or a low, reading, depending on the engine running speed, or the oil temperature. In normal operating conditions, with the engine warm, between 2,000 rpm and 7,000 rpm, the reading should be between 4.0 and 5.0 Bar. If the reading falls below approximately 2.0 Bar in this engine range, turn the engine off, and check the oil level. If the oil level is not at fault, have the lubrication system checked by a FORD dealer.

The pressure reading at engine idling speeds should be between 1.5 and 2.0 Bar. (Oil pressure warning light will illuminate at idle).

8 (4) Oil Pressure Warning Light

This light is illuminated when the ignition is first switched ON, but should extinguish as soon as the engine has been started. This confirms that the oil pressure in the engine is within the normal range. If the light fails to go out when the engine is running, or illuminates during normal driving, *stop the car as soon as it is safe to do so*, and investigate. See 'Pressure Gauge', below. The light is set to illuminate below 1.2 Bar/17.5 psi.

Note: Oil light also comes on when pressure falls below 2 Bar eg at idle speeds.

7 (5) Tachometer

This indicates the engine speed, in revolutions per minute. The normal safe maximum engine speed is 7,000 rpm (see TECHNICAL DATA), but we recommend changing up to a higher gear before the peak of the power curve, which occurs at 6,500 rpm.

6 (6) Handbrake/Brake fluid level warning light

With the ignition ON, this light will illuminate whenever the handbrake is applied. If the light comes ON while you are driving along, first check that the handbrake lever is fully released. If the light still remains ON, stop at the first opportunity, and check that one of the hydraulic fluid circuits has not lost fluid.

5 (7) Speedometer

The distance recorder registers the total distance travelled by the motor car. The trip recorder registers the distance covered since the reset button was last twisted to Zero.

1 (8) Fuel contents gauge

This indicates the level in the two fuel tanks, combined. Maximum capacity is 89.9 litres (19.8 Imperial gallons).

2 (9) Fuel pressure gauge

This indicates the pressure of fuel being supplied from the electrical fuel pumps to the engine injection system. Normally, this should indicate between 3.0 and 3.75 Bar at typical engine speeds.

3 (10) Voltmeter

This indicates the condition of the electrical supply system, and of the battery itself. Normally, when the car is in use, the needle should indicate about 14 volts. If the gauge reading drops below 12 volts, check that the generator is still working properly, and check the condition of the battery. If the gauge reading rises into the red sector, above 15 volts, arrange to have the system checked by a FORD dealer. The gauge normally reads Zero when the ignition circuit is switched OFF.

4 (11) Turbocharger boost gauge

This indicates the pressure, above or below atmospheric normal, in the ducting between the turbocharger and the engine inlet manifold. Positive boost begins to be developed above 2,500 rpm when full throttle is used. Peak boost is 0.75 Bar/ 11.0 psi.

27 (12) Main beam warning light

This will illuminate whenever the head lamps are on Main Beam, or whenever the headlamp flasher lever is operated.

26 (13) Variable intermittent wipe control

The interval between wipe phases can be adjusted by this control. Turn the wheel to the right to increase the interval between wipes, or to the left to reduce the interval.

25 (14) Direction indicator warning light

This flashes whenever the indicators are in operation. The flashing frequency will double if an indicator bulb has failed.

24 (15) Hazard flasher switch

To operate the flashers, press this switch firmly down. Thus activated, the hazard flasher circuit causes all direction indicators to flash simultaneously, to warn approaching motorists of possible danger, or of a breakdown.

To cancel, press the switch once more, when it will return to the OFF position.

23 (16) Transfer box temperature warning light

Transmission oil is also circulated through the transfer gearbox at the front of the engine, where a temperature sensor is fitted. With the ignition switched ON, the warning lamp illuminates if the fluid temperature exceeds 115 degrees Celcius, and it will not then be extinguished until the temperature falls below 85 degrees Celcius.

If the light illuminates for any reason, stop the car as soon as it is safe to do so, switch off the engine, and investigate. Check that the transmission oil level is correct (see REGULAR MAINTENANCE, and CARE, page 06-3), and that no leaks have occurred.

Do not continue to drive the car while the warning light remains illuminated.

22 (17) Instrument illumination control

Rotate this to adjust the brightness of the instrument panel illumination.

21 (18) Speedometer trip reset button

To measure the distance of any particular journey, twist the button in the face of the speedometer, to 'Zero' the trip indication at the start of the journey.

12,13,14,15 (19,20,21,22) Spare switches, for extra circuits

These switches, which are not wired into the standard loom, are provided for the convenience of the owner, who may wish to add extra lamps, map reading equipment, or related navigational equipment. Access to the back of these switches is gained by removing the panel in the normal way.

16 (23) Space for Mounting a Radio/Cassette player

A radio is not fitted to the standard RS200, but this panel may be removed, and a receiver/cassette player fitted in its place. There is provision for loudspeakers in the passenger footwells.

18 (24) Long range lamp switch (lamp not fitted on standard car)

Provision is made in the car's standard wiring loom, for auxiliary long range driving lamps to be mounted at the nose of the car, to the owner's individual requirements. This switch controls that auxiliary circuit. The lamp only illuminates when the headlamps are on MAIN BEAM, and the ignition switch is ON.

17 (25) Fog/spot lamp switch (lamp not fitted on standard car)

Provision is made in the car's standard wiring loom, for auxiliary fog or spot lamps to be mounted at the nose of the car, to the owner's individual requirements. This switch controls that auxiliary circuit. The lamp only illuminates when the headlamps are on MAIN BEAM, and the ignition switch is ON.

19 (26) Twin front fog lamps switch

This switch operates the twin auxiliary lamps which are mounted low down in the front apron. Even with this switch ON, these lamps are only illuminated when the side lamps or the headlamps are in use. They do not extinguish when the ignition is switched OFF. A warning light at the switch illuminates when the lamps are ON.

20 (27) Rear fog warning lamp switch

Rear fog lamps should only be used in conditions of poor visibility as they are very bright, and might otherwise dazzle following drivers. They operate when either side lamps or head lamps are switched ON.

WWW.RS200.ORG

SWITCHES ON STEERING COLUMN

Multi-function switch

This switch performs the following functions when the ignition is switched on (position II):

1. Right turn indicator.
2. Left turn indicator.
3. Main beam (when headlights are on).
4. Headlamp flasher control operates by gently pulling the lever towards the steering wheel.
5. Horn.

Multi-function switch

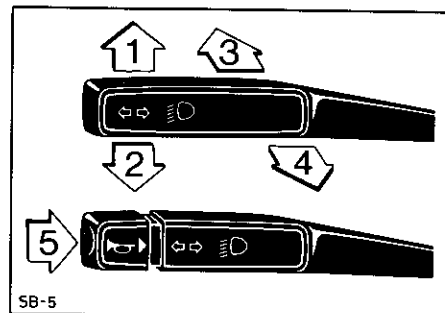

Lighting switch

This switch has the following positions:

1. Side and tail lights on.
2. Headlamps, side and tail lights on. The headlamps will be on main or dipped beam, depending on the position of the multi-function switch.

Lighting switch

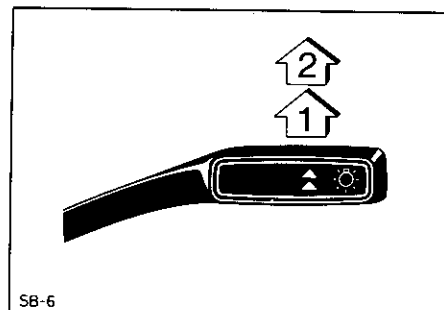

Windscreen wash/wipe switch

This switch performs the following functions when the ignition is switched on (position II):

1. Normal wiper speed.
2. Fast wiper speed (for extreme conditions).
3. Single wipe or intermittent wipe function. Use in light rain or mist.
4. Windscreen washers - keep button depressed for prolonged washer operation.

Windscreen wash/wipe switch

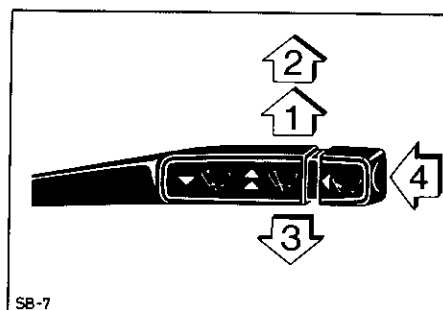

RADIO INSTALLATION

Although a radio installation is not part of the standard specification of the FORD RS200, space has been made for any of the standard range of FORD Audio equipment to be fitted.

When fitted, the receiver is positioned in the central instrument/switchgear panel, close to the heating and ventilation controls.

Adequate High Tension Ignition lead suppression is standard on the RS200, so no extra suppression is needed to ensure adequate radio reception. In particular, do not fit carbon core H.T. wiring. If a radio is fitted, it is recommended that the most convenient position for the aerial is on the roof, above the passenger compartments. There is a metallic insert in the roof panel to help idealise reception, in the form of a cross. The base of the aerial should be placed on the centre of the roof panel, 400 mm \pm 20 mm (15.75 in. \pm 0.75 in.) back from the edge of the windscreen aperture.

Space for fitting audio equipment



WWW.RS200.ORG

Multi-function digital clock

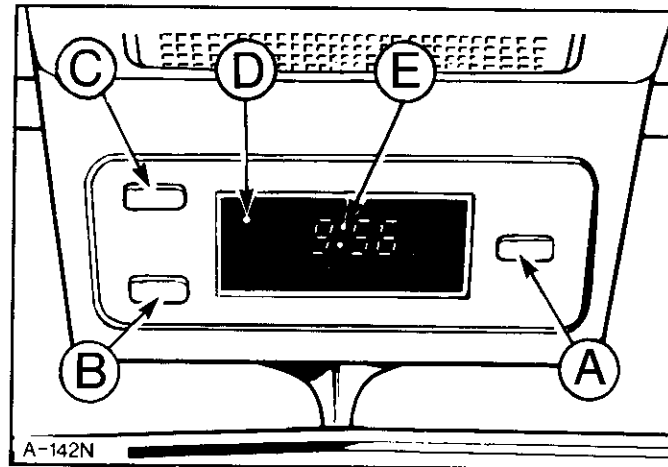

Type fitted in overhead console.

- A – Select button (selects display).
- B – Reset button (setting sequence and timer zero).
- C – Adjust button (setting, timer stop/start, and quick time set).
- D – Timer symbol.
- E – Colon.

The following displays may be selected:

- Digital Clock – shows time in hours and minutes
 - Date – shows the day on the left and the month on the right.
 - Timer - shows the elapsed time from a chosen moment in minutes and seconds or hours and minutes
- On switching on the ignition the clock will display the time. It has a 12-hour or 24-hour selectable format with a colon (E) between the hours and minutes. When the clock is running the colon flashes every second. The display is dimmed when the vehicle's exterior lights are switched on. To obtain the 'Date' display, press the select button (A) once. After 4 seconds the 'Digital Clock Display' will reappear. To obtain the 'Timer' display, press the select button (A) twice. The unit will now show '00-00' with the colon static. To revert to the normal 'Digital Clock' display, press the select button (A) once again. All settings and adjustments can only be made with the ignition switched on.

To set time and date

Setting must be carried out in the following sequence.

1. 12/24 Hour Format
With the unit showing time press reset button (B) once. The display will flash showing '12H' or '24H' depending on whether the clock is set to display time in 12-hour or 24-hour format. Press adjust button (C), to change display format.
2. Hours
Press reset button (B) again. The hour number on the left will now flash. If 24-hour format was selected the minute number on the right remains static. If the 12-hour format was selected an 'A' for am or 'P' for pm will appear in place of the minutes. Press adjust button (C), to increase the flashing hour number.
3. Minutes
Press reset button (B) again. The minute number of the right of the display will now flash. Press adjust button (C), to increase the flashing minute number.

4. Month

Press reset button (B) again. The unit will now display the date, with the day number on the left, and the month number flashing on the right. Press adjust button (C) to increase the flashing month number.

5. Day

Press reset button (B) again. The unit will now show the day number on the left flashing, with the month number on the right static. Press adjust button (C), to increase the flashing day number.

After making adjustments, press reset button (B) to return to display of time. To revert to time display at any point during the above setting sequence press select button (A).

Quick time set

Whenever the clock reads 58,59,00 or 01 minutes past any hour, it can be reset to 00 minutes 00 seconds by pressing the adjust button (C) once. For minutes 58 and 59, the hour will be incremented by one, but for minutes 00 and 01, the hour displayed is unaffected.

Timer operation

To Start and Stop Timer:

With the clock showing time, push select button (A) twice. The clock will display '00-00' with the colon static. To start the timer press adjust button (C) once. The colon will flash and a dot, the timer symbol (D), appears on the top left of the display. Pressing the adjust button (C) a second time stops the timer and freezes the display. A third press will restart the timer from where it stopped.

The timer counts to 59 minutes 59 seconds, and then rolls over to 1 hour 00 minutes and continues to count at one-minute intervals. When it reaches 59 hours 59 minutes, it automatically resets to zero and continues counting.

Either of the other two display can be selected when the timer is in operation. To obtain the normal time display, press the select button (A) once. To obtain the date display for 4 seconds press button (A) again.

The timer symbol (D) will appear on both the time and the date displays when the timer is in operation. The timer cannot be stopped or started when the unit shows the normal time display.

To Reset Timer to Zero:

With the clock showing time, press select button (A) twice to display the timer. To zero the timer push reset button (B). If the timer was running the timer symbol will disappear. The unit can now be set to show the normal time display (by pressing select button 'A'), or the timer can be restarted (by pressing adjust button, 'C').

The recorded time display when the timer is stopped will be left in its memory until the timer is restarted again, even if the ignition is switched off. However, if the timer is running when the ignition is switched off, it will continue to record elapsed time until the ignition is switched on again and the timer is stopped or reset. Thus the timer can be used to record actual driving time or total journey time.

Ignition Off Recall

To avoid unnecessary drain on the battery, no display is shown once the ignition has been switched off. However, the display can be recalled for 4 seconds by pressing the select button (A). One press of the select button will display time, further presses will display date and timer. Adjustments can only be made with the ignition switched on.

HEATING AND VENTILATION

Air enters the vehicle through a vent at the front of the car and flows through the blower unit, the heater housing and air ducts to the vents in the passenger compartment.

- Without blower assistance, the amount of air entering the vehicle is dependent on road speed only. Therefore, when driving slowly, with average ambient temperatures, use blower on lower or middle speed setting. In very cold or hot weather use position III
- If the windows are misted over or iced up, direct all air flow to windscreen and switch on blower to medium or high speeds as appropriate. Adjust temperature to highest comfortable setting. Additionally, open side vents and direct air flow to side windows.

⚠ WARNING—It is essential that all windows and exterior mirrors are adequately cleared of mist, frost or snow before driving.

- To prevent the entry of unpleasant odours from outside the vehicle (eg in traffic jams) close the air intake temporarily by switching off the heating, closing all vents and switching off the blower.

The air temperature for all outlet and air flow distribution to the windscreen and floor area can be adjusted with the heater control levers. The amount and direction of air entering the car interior from the centre and side vents may be controlled by turning the knurled wheels and moving the adjustable louvres.

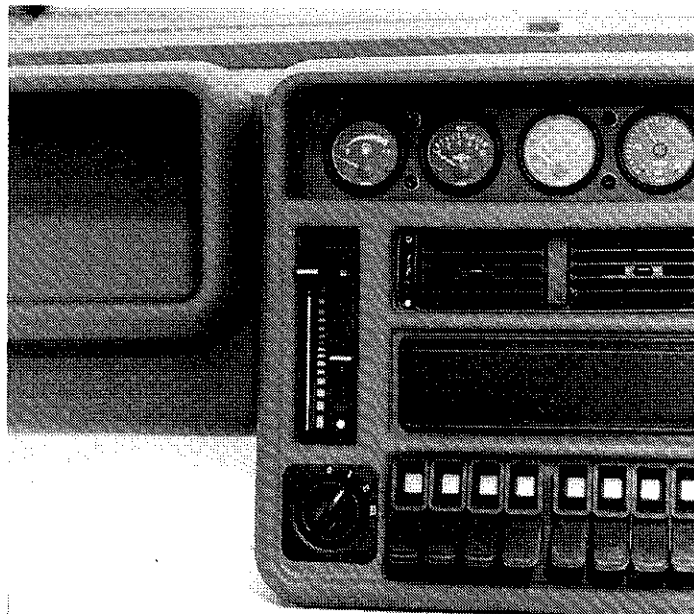

1 Temperature control-lever

Lower position: cold (ambient air from outside vehicle).

Upper position: warm.

The lever may also be set to any intermediate position to vary the temperature as desired.

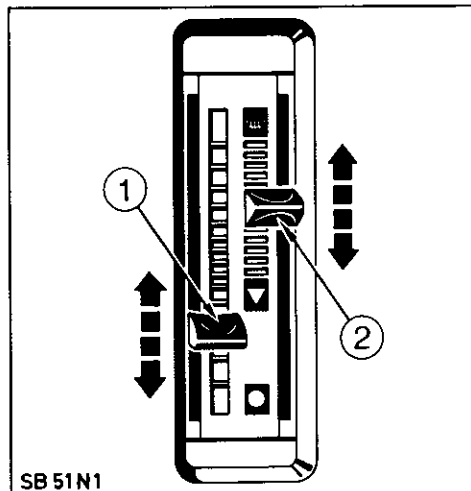

2 Air distribution-lever

▲ Air flow to windscreen to de-ice or demist.

▼ Air flow to floor area.

At intermediate positions between ▲ and ▼, the flow of air is apportioned between the floor area and windscreen.

● Air exits to windscreen and floor area closed.

At intermediate positions between ▼ and ●, there is a reduced flow of air to the floor area. Side and centre vents operate independently from the air distribution lever.

A Blower control

To increase air flow turn rotary switch clockwise as follows:



- I – Low-speed
- II – Medium-speed
- III – Max-speed

Side vents

- moveable lever to open/close vent
- adjustable louvre

Centre vents

- moveable lever to open/close vent
- adjustable louvre

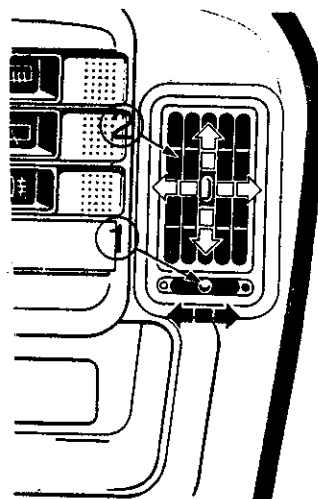

TYPICAL CONTROL POSITIONS

A Heating/ventilation at moderate ambient air temperatures

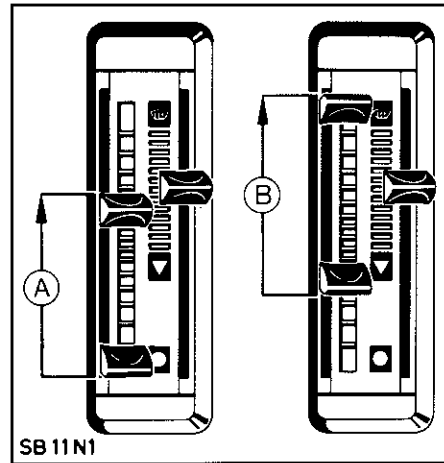

The temperature of air flow from the outlets to the floor area, windscreen and side vents is progressively increased. The air from the centre vents, however, remains cooler.

B Heating in extreme cold conditions

The air flow from the vents, *including the centre vents*, is progressively warmed. When the left control lever is in the extreme top position, warm air flows simultaneously out of *all* the air outlets.

C Windscreen defrosting/demisting

For optimum results, direct maximum air flow on the windscreen and adjust temperature control to the highest comfortable setting. Additionally open side vents and direct the air flow onto the door windows. As soon as the windows are cleared, the controls may be adjusted to positions suitable for the comfort of the occupants.

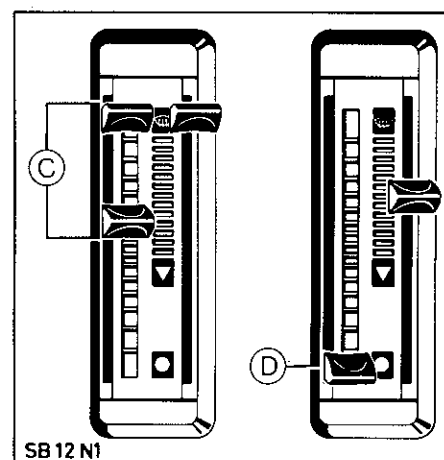

D Ventilation in warm climates

The air flow is equally directed between the floor area and windscreen and the temperature control set to 'cold'. If desired, open the side and centre vents and adjust the direction of the air flow as required.

Door locks

The internal door locking lever is situated inside the door handle. When the locking lever is depressed the door is locked. To open the front doors from the inside when locked, it is only necessary to pull the door handle outwards from its recess.

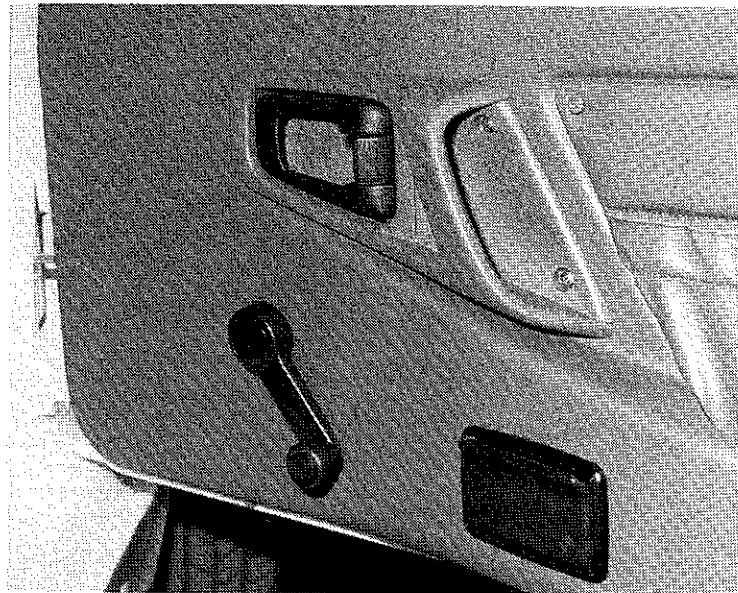
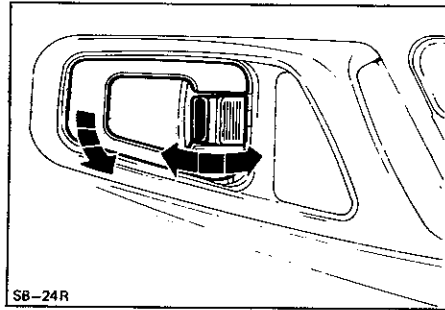

WWW.RS200.ORG

FILLING STATION INFORMATION 03

Index

	Page
In the Engine Bay	2-4
In the Front Compartment	5
Fluid Replenishment	6
Battery Checks and Charging	7-8
Tyres and Tyre Pressures	9

WWW.RS200.ORG

FILLING STATION DATA

In the Engine bay

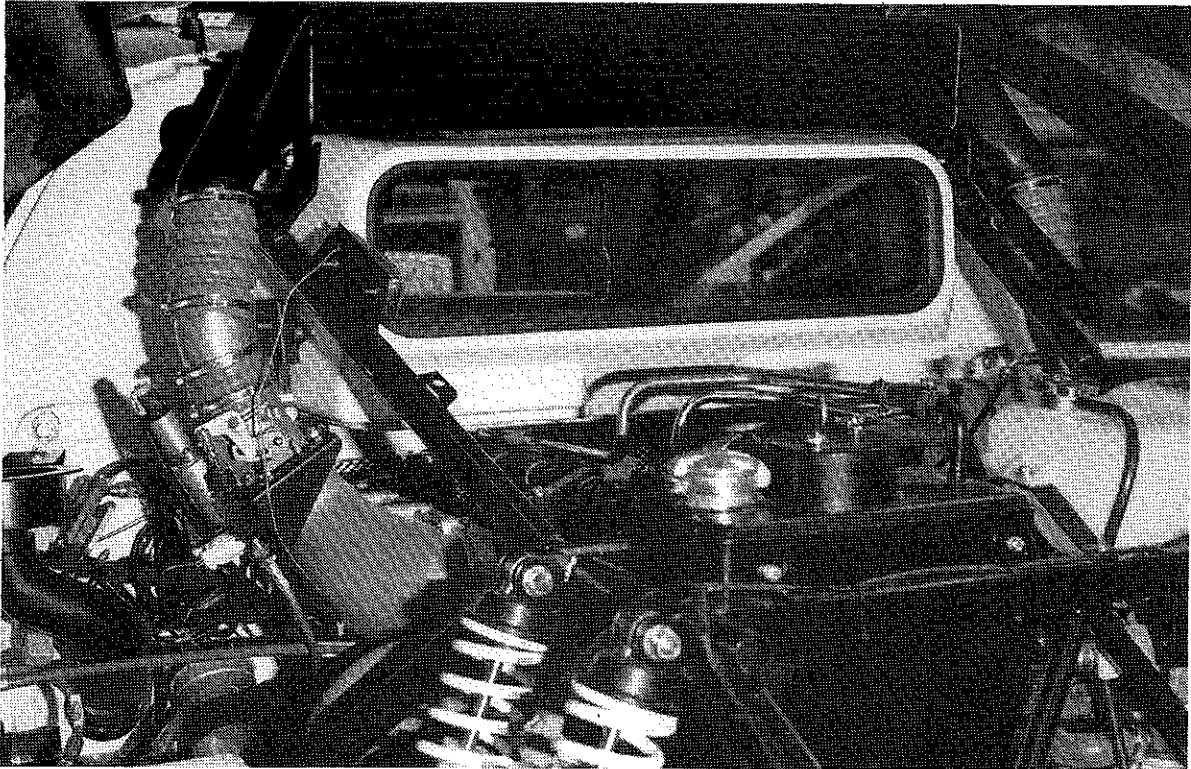

Rear bodywork completely removed

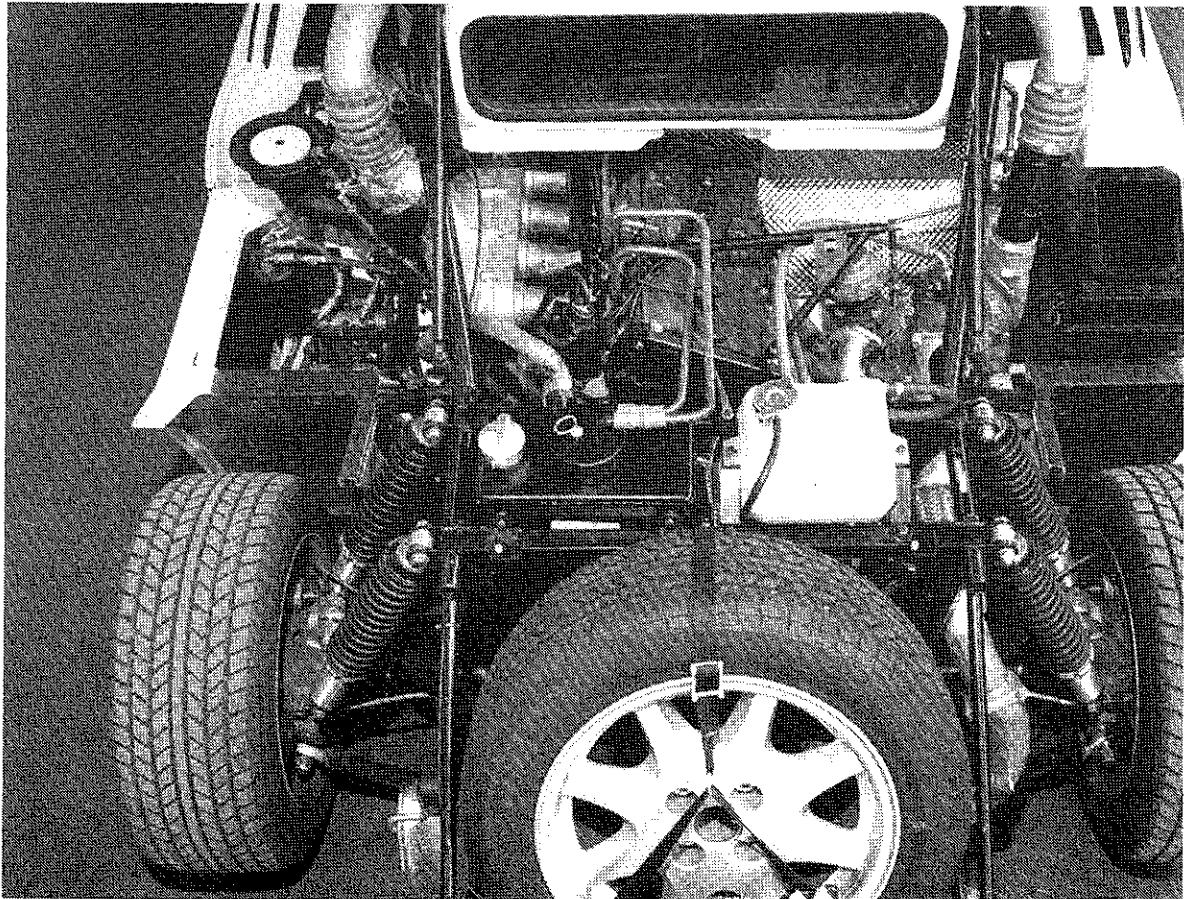

WWW.RS200.ORG

UNDER THE LIFT-UP REAR BODY SECTION (ENGINE BAY)

Cooling system

The expansion tank/header tank is a translucent plastic unit, positioned in the tubular sub-frame, above and behind the engine itself. The cap, which has a pressure rating of 15 psi, has a twist action to release it. The coolant level is visible through the translucent walls of the expansion tank. When the system is cold, the coolant level should be level with the MAX mark on the expansion tank. The cooling system must only be topped up through the expansion tank filler neck.

⚠ WARNING—To avoid being scalded, the coolant level should only be checked when the engine is cold, and the ignition is switched OFF. Before removing the expansion tank cap, turn the cap slowly to the first stop, so that pressure in the system is released.

Slight raising of the coolant level above the MAX mark, when the engine is hot, is normal, and may be disregarded. If the level is too low, top up the coolant reservoir with the specified coolant, which must be a 50/50 per cent water/inhibitor mixture. After two years, the cooling system should be flushed out, and the coolant replaced as specified, because after this period the original coolant will no longer provide adequate corrosion protection. Contact your FORD dealer for expert advice.

Air cleaner

This housing, mounted low down, to the right side, immediately behind the bulkhead to the passenger compartment, contains a filter element, which must be replaced at the specified intervals (See SERVICING THE CAR).

Make regular checks to ensure that the cleaner element is not becoming clogged with foreign matter. This is especially important where an RS200 is habitually driven on dusty, or unsurfaced road surfaces.

Air Cleaner Element Housing

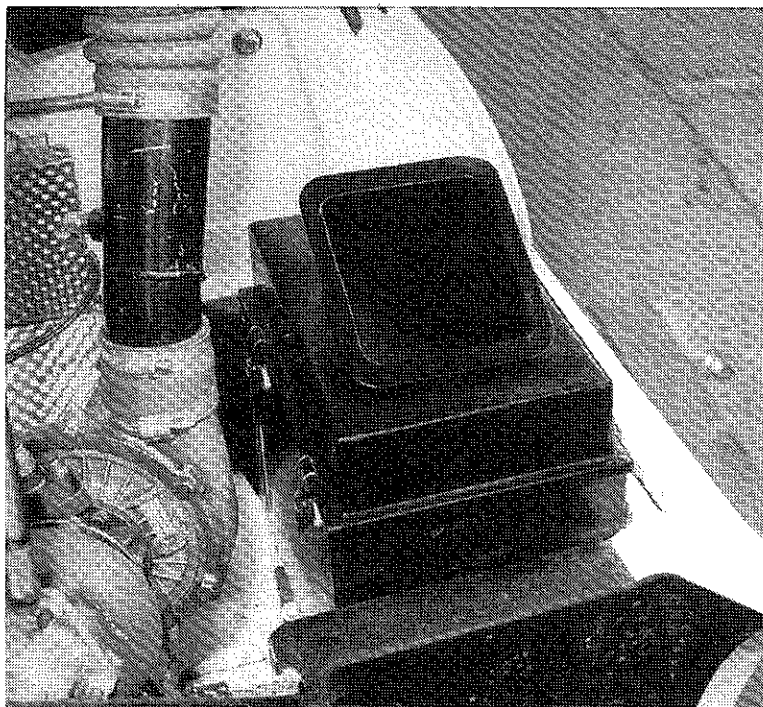

FORD/AAGR/RS200 FILLING STATION INFORMATION/4

Alternator drive belt

The alternator is situated to the left side of the engine, as installed in the car and as viewed from the rear, close to the engine oil tank. Take every opportunity to check that the Drive Belt tension is correct. This is essential, to ensure adequate belt life, and to avoid belt slipping.

 *Note: Before loosening alternator fixings to adjust the drive belt tension, the battery must be disconnected.*

Engine oil system and tank

Lubrication is by a 'dry sump' system, which means that there are pressure and scavenge pumps in the system, but very little oil is normally held in the pan under the engine's crankshaft. Most oil is stored in the tank, which is positioned in the tubular subframe, immediately behind the engine itself.

The oil tank has a snap-action filler cap.

To check the level of oil in the system, be sure to have the engine operating at a normal temperature, and allow it to idle for 20 to 30 seconds before measuring the level, within 30 seconds of stopping engine. Check the level at every fuel stop, and make sure the car is standing on level ground. Pull out the dipstick from the top of the oil tank, wipe it with a clean, non-fluffy cloth, re-insert it and then pull it out again. The film of oil clinging to the dipstick will indicate the oil level.

If the oil level has fallen to the lower 'MIN' mark on the dipstick, the system should be topped up without delay, to bring the level back to the 'MAX' mark. The amount of oil needed for topping up from the lower to the upper mark is approximately 2 litres/4 pints.

Do not overfill.

Erroneous low level warnings may occur if the vehicle is not positioned on level ground.

Brake pads

When the rear body section is lifted for attention to maintenance items in the engine bay, a visual check should be made of the condition of the rear brake pads.

There are two different sets of calipers at the rear of the RS200. The calipers towards the front of the car are connected to the hydraulic footbrake circuits, while those towards the rear of the car are connected, by cable, to the handbrake lever.

Fuel filler cap

This is accessible with the rear body section raised, and is lockable. The single filler serves both tanks, which have interconnecting pipes to equalise their levels.

After refilling, ensure that the filler cap is properly refitted and locked. The key for this purpose is the same as that used in the ignition/steering column lock barrel.

UNDER THE LIFT-UP FRONT BODYWORK (FRONT COMPARTMENT)

Vehicle identification plate

This is situated on a panel behind the right front wheel, on the passenger bulkhead. For further details of the numbering system, see KNOW YOUR CAR.

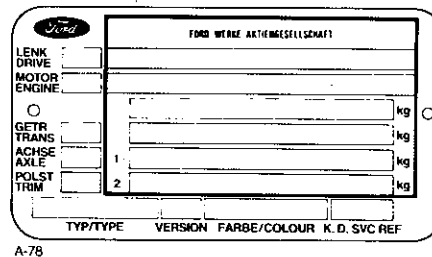

Windscreen washer reservoir

This is located in the recess on the right side of the front lower body apron, and can be inspected when the front body section is raised.

The fluid level in the reservoir should be checked regularly, and topped up when necessary with a mixture of clean water and Motorcraft screen-washer additive with antifreeze protection if necessary. After filling the reservoir, operate the washer control once to ensure that the system is primed and the jets are working.

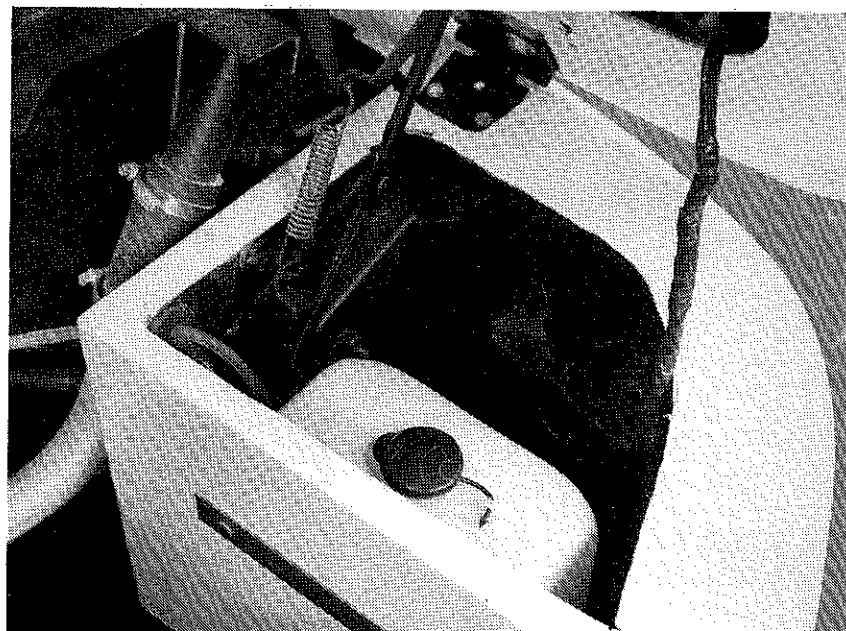
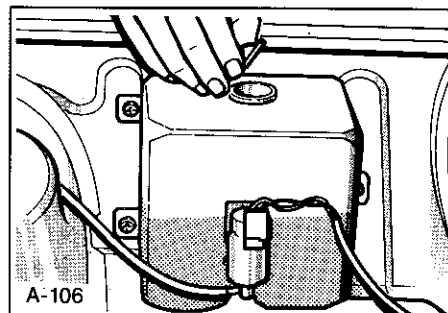

Brake and clutch fluid reservoir levels

Three fluid reservoirs, are located near the tubular cross-member, linking the front suspension spring pivot points on each side of the car. The two larger reservoirs carry fluid for the front and rear hydraulic braking circuits, the third reservoir carries fluid for the hydraulic clutch mechanism.

Checking the brake fluid level is one of the most important safety precautions. The MAX line on the reservoir indicates the highest permissible fluid level. The fluid will fall slightly over a long period due to the automatic adjustment of the disc calipers for wear. When unscrewing the cap of the reservoir, hold the cable connector for the brake fluid level warning light.

If the fluid level requires frequent topping up, have the brake system checked by your FORD dealer.

⚠ WARNING—Never let the fluid level fall below the 'MIN' line.

The efficiency of the brakes may be impaired if fluid is used which does not meet FORD specification. Only top up with a fluid meeting Automotive Products AP DOT 4 specification. Do not use brake fluid that has been exposed to the air for any length of time. Moisture absorbed from the air dilutes the fluid and reduces its efficiency.

⚠ WARNING—If brake fluid is spilled on paintwork the affected area must be washed down with a wet sponge immediately.

Brake fluid reservoirs

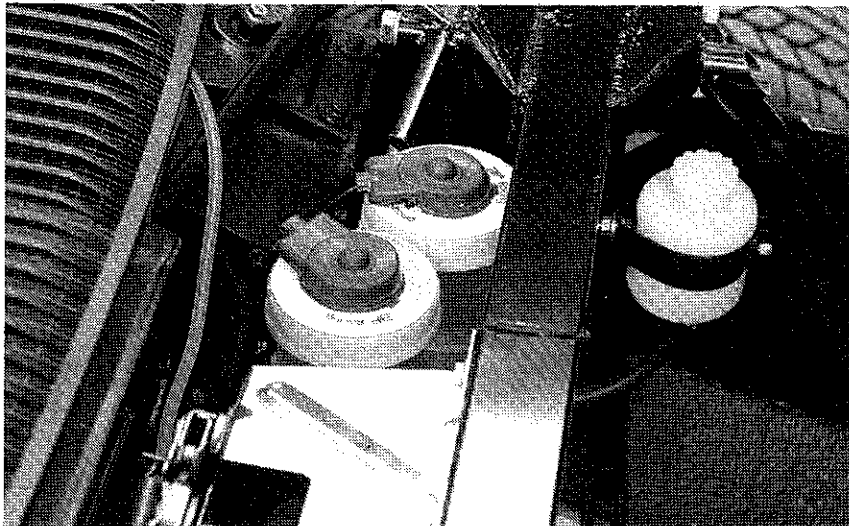

Clutch fluid reservoir level

The level of fluid in the clutch reservoir should be checked at the same time as you check brake fluid levels. There should be no fall in the level over a long period; if this level requires frequent topping up, have the system checked by your FORD dealer.

⚠ WARNING—Never let the fluid level fall below the 'MIN' line.

Always use the same specification fluid as is used for the braking circuits, and take the same precautions in regard to moisture, and spillage on the bodywork.

Battery

This is located low down, in a cradle, immediately behind the front box-section cross-member of the body/chassis unit.

The battery is 'Maintenance Free'; checking and topping-up of the electrolyte level is not required throughout the normal life of the battery.

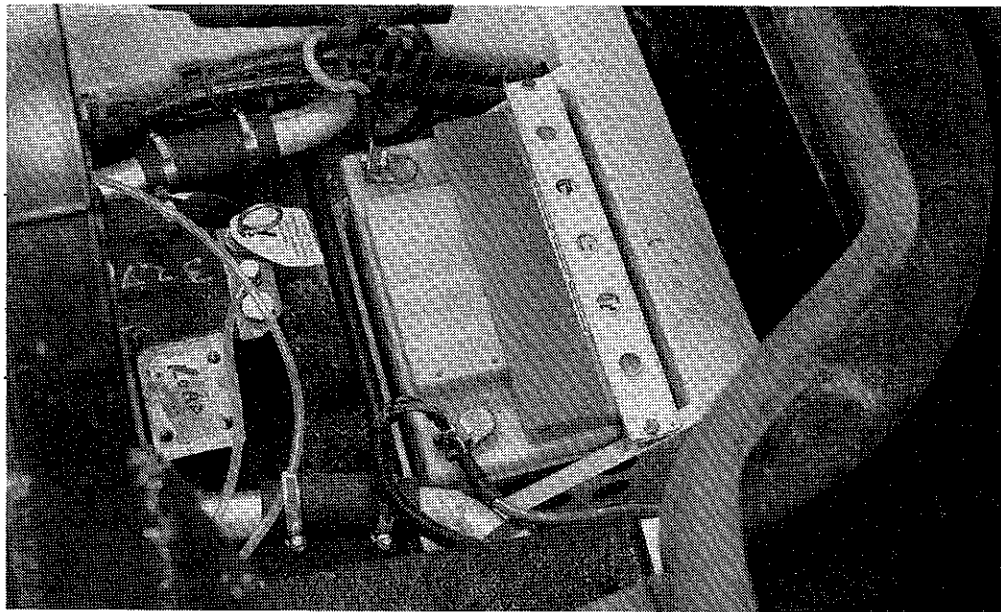
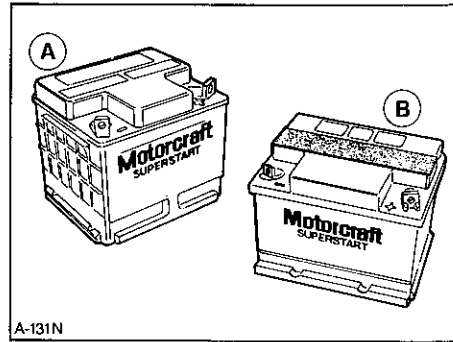

Battery identification

A – 'Maintenance Free' battery with sealed cell top.

B – 'Maintenance Free' battery with removable cell top.

Further identification of later level batteries is provided by a sticker. This sticker is attached to the front and rear surfaces of the battery and indicates that the battery is 'Maintenance Free' and should not be topped up.

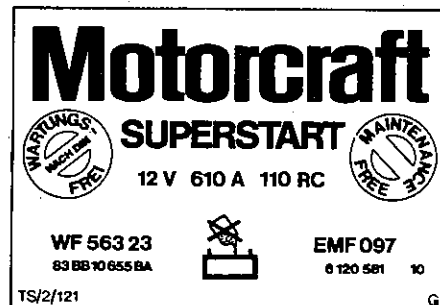

N.B. On road cars access to the battery is through a removable panel in the floor of the luggage box.

Terminal connections



WARNING:

- The battery leads should be disconnected only with the engine switched off. When disconnecting the battery, always remove the negative (ie earth) lead first.
- Do not let the spanner touch both terminals of the battery or the positive terminal and any part of the vehicle body. This will short-circuit the battery.
- When reconnecting the battery, ensure that the negative terminal is connected last.
- The main wiring loom is connected to the positive terminal of the battery by a 'fuse link'. If the vehicle battery or any auxiliary battery is connected incorrectly, or if there is a short circuit in the loom, this link will 'blow' and all of the electrical system will cease to operate. The link should be replaced by your FORD dealer if this should occur.

Battery charging (all variants)



WARNING—If the battery is to be charged while still in position in the car, it **MUST** be disconnected from the car's wiring loom.



WARNING—The process of charging a battery causes highly inflammable hydrogen gas to be formed. Consequently, when charging a battery, the following precautions must be observed:—

- Charging must be carried out in a well ventilated area. When charging in situ, the bonnet should be left open.
- The battery charger must be switched off before disconnecting the charging leads from the battery.
- Never smoke or ignite a naked flame near a battery which is being charged, or has just been charged.
- When bench charging, do not refit the battery in the vehicle for five to ten minutes after the charging equipment has been disconnected as the battery continues to give off hydrogen gas for a short period after the charging has been completed.

It is unnecessary to remove or loosen the vent caps (where fitted) during charging.

'Maintenance Free' battery charging

Should a 'Maintenance Free' battery become partially discharged and fail to start the vehicle, it can be recharged using normal 12 volt charging equipment. However it is recommended that the charger is switched off if the electrolyte starts to effervesce.



WARNING—Never use a battery charger with a nominal voltage greater than 12 volts. If a normal 12 volt charger fails to recharge a 'Maintenance Free' battery, have the battery checked by your FORD Dealer.

TYRES AND TYRE PRESSURES

Tyre care

Run-in new tyres gently for the first 150 km/100 miles, by not driving at very high speeds, and by avoiding sharp cornering, and fierce braking.

Recommended tyre pressures, front and rear, are 2.0 Bar/29 psi. Check, and if necessary, adjust the tyres only when the tyres are cold. Use an accurate tyre pressure gauge. Do not forget to check the spare wheel, which is housed in the tail of the chassis, behind the oil tank, and the radiator header tank.

⚠ *WARNING—Driving an RS200 on tyres inflated below the specified pressures affects the safety of the tyres, leads to premature wear, and to high fuel consumption. Unbalanced wheels cause uneven wear. If a tyre is damaged, you should consult a tyre specialist, preferably one familiar with the very high-performance Pirelli P700 tyre. Never attempt a makeshift repair yourself. It is essential that replacement tyres should be of the same size, profile, type, and speed rating as those originally fitted to the RS200. Any variation could adversely affect safety and handling. Never drive at high speed on a tyre which has received a puncture repair. Such a tyre should be replaced as soon as possible.*

Tyre tread

Check tubeless radial tyres at least once a month or before commencing long trips. Is the tyre pressure correct? Are there any signs of cuts, damage to the side-walls and tread, foreign matter, or excessive wear? Uneven tyre wear may indicate incorrect wheel alignment.

Tyre depth

Measure the depth of the tread in several places across the width of the tyre. Pay attention to legal requirements regarding tyre depth.

Winter tyres

When operating the vehicle with winter tyres, which must be fitted to all four wheels, do not exceed the permitted maximum speed for the tyres as given by the tyre manufacturer.

Snow chains

Snow chains can be fitted to the tyres. It is advisable to use chains with small links to ensure sufficient clearance between chains and wheel arches. The chains must be removed when driving for long distances on snow-free roads.

WWW.RS200.ORG

ROADSIDE EMERGENCIES 04

Index

	Page
Towing and Jacking	2-3
Spare wheel and wheel changing	4-5
Starting, using 'Jumper' cables	6
Bulb replacement	7-11
Fuses, Relays and replacement	12-15
Drive and alternator belt adjustment	16
Wiper blades and windscreen washers	17-18
Fault finding and diagnosis	19-24

WWW.RS200.ORG

Towing the vehicle

There is a towing eye at the front of the chassis underside of the vehicle, for attachment of a tow rope or cable.

Do not attempt to tow the RS200 by attaching ropes or cables to any other part of the car except the main structural chassis, and most particularly not by using the front or rear suspension links.

⚠ WARNING—When towing the RS200, ensure that the starter switch/steering lock key is in position II (steering lock released, and ignition warning light illuminated). Only then will the steering, direction indicators, horn and brake lights all be operational.

Tow/push starting

If a booster battery and jumper cables are not available, the engine can be started by towing, as follows:

1. Turn the ignition key to position II.
2. Operate the accelerator pedal slightly.
3. Depress the clutch pedal, engage third gear, and hold the clutch pedal depressed.
4. Tow the vehicle, using the towing eye at the front of the structure, and gradually engage the clutch.
Do not do this in a rough manner, for there is otherwise a possibility of 'jumping' a tooth on the engine timing belt.

When being towed, and the engine fires, take care not to run into the towing vehicle, in front. It is not recommended that the RS200 be push started, as too much strain may be applied to the rear body section. This may distort or even crack it, and it may also damage the hinges.

Towing Eye position – left side front



Jacking up the vehicle

Two jacking points are provided on each side of the RS200. These are hidden behind plug covers in the body sills under the doors. Always select a front point to raise a front wheel, or a rear point to raise a rear wheel.

If it is intended to remove a wheel after jacking, slacken off each wheel nut by turning anti-clockwise for half a turn before jacking up the vehicle.

To jack up, remove the jacking point plug (prise it gently out, with the aid of a screwdriver). Slide the jack arm into the hole, ensuring that it has maximum penetration, and that it is not restricted by mud, or other road debris.

Before jacking the vehicle, make sure that the car is on level ground, and that the ground is sufficiently solid enough to support the jack and any additional supports used. If jacking up on a gradient cannot be avoided, see that both wheels on the opposite side of the vehicle are securely chocked. Always apply the hand-brake.

Insert the jack into the tube at its natural angle. The shaft will gradually take up a vertical position as the car is jacked up.

Jack the vehicle by 'pumping' the jack handle, until the required lift has been achieved, and the wheel is clear of the ground.

To release the jack, pull up on the handle, smartly, and the locking action is released, the jack descending immediately.

Before driving off, replace the jacking point plug cover, so as to protect the recess from accumulating road filth.

⚠ WARNING—Never work under a vehicle that is only supported by a jack. Use additional means of support. If a trolley jack is used, it should be placed only under the areas marked in the illustration. Do not use a jack under any other part of the vehicle as this may cause serious damage to underbody steering, suspension, engine or brake and fuel line components. Always use a block of wood above the jaws of the trolley jack, to obviate damage to the structure.



Spare wheel, and wheel changing

The spare wheel is located under the rear body cover, behind the engine, and the rear differential. To gain access to it, unlatch the rear body section from inside the car, swing it open, and securely prop the gas strut.

Taking care not to contact the exhaust system (which is close to the spare wheel fixing, and may be hot), unclip the webbing straps which hold the spare wheel and tyre, and remove it from the vehicle. Before attempting to change a wheel, ensure that the spare tyre is correctly inflated.

The jack, and the wheelbrace, are both fixed to the frame at the rear of the chassis, which also supports the spare wheel. To remove the jack, the spare wheel should first be removed from its own mounting.

Temporarily return the rear body section to the closed position, then proceed as under 'Jacking up the Vehicle', having first made sure that the appropriate wheel nuts have been slackened off before jacking commences.

Note: The Pirelli P700 tyre is 'directional', and the recommended forward direction of rotation is shown by four arrows moulded into the sidewalls at 90 degree intervals. This directionality enables the handling and adhesion to be optimised for both wet and dry road conditions.

In an emergency (i.e., after a puncture), the spare wheel and tyre may be fitted to a location where its direction of rotation is incorrect, but this should only be done as a 'get you home' measure. We recommend that the tyre situation should be rectified as soon as possible after such an emergency fitment, and that meantime the driver should moderate his driving to avoid showing up any slight asymmetry in handling which may occur under extreme braking or cornering conditions.



 **WARNING**—Never work underneath a raised vehicle which is only supported by the jack. Especially if one or more wheels are to be removed for a period of time, always use additional supports, such as axle stands with wooden blocks to spread the load, if these are positioned under the body/chassis unit sides.

Punctures, and alternative tyre equipment

If the Pirelli P700 tyres fitted to this car suffer a puncture, Pirelli Ltd. advise that it is permitted to repair them, within the restrictions of the relevant British Standard (BS AU 159c : 1981). Pirelli Ltd., however, do not advocate the repair of ultra high-performance tyres, and cannot be held responsible for the performance of a repair carried out by a third party.

A winter-treaded tyre is available to replace the 225/50-16 P700 tyre. This is the 205/55-16 Pirelli Winter 190. Owners should know that this tyre is designed for use up to 190 kph/119 mph, and for this reason it is not provided with holes suitable for stud insertion. The Winter 190 has exactly the same rolling radius and revs/mile specification as the P700 itself.

More detailed advice on these tyres may be obtained from:

**Pirelli Performance Bureau,
Pirelli Ltd.,
Derby Road,
Burton on Trent,
Staffordshire DE13 0BH,
UK.
Tel: 0283-36061.**

Snow chains

Snow chains may be used with the P700 tyres, but their use should be restricted to real emergencies. Ideally they should be of a low-profile type that minimises local deformation of the tyres.

WWW.RS200.ORG

Starting the car using 'Jumper' cables

If your car has a flat battery you can start the engine by connecting a second battery to your battery as illustrated.

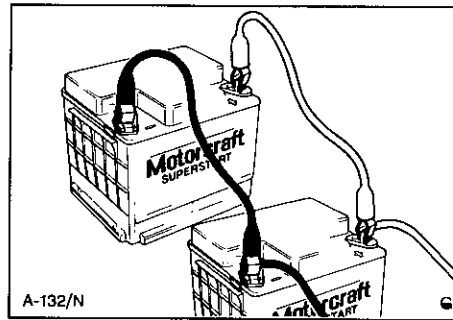

⚠ WARNING:

- Never connect jumper cables to more than one slave battery, or to a battery which has a nominal voltage greater than 12 volts.
- The cables should always be connected to the booster battery first to reduce the possibility of sparks.
- The positive (+) terminal of the batteries must be connected through one cable (usually red) and the negative (-) terminals connected through the other cable. If this procedure is not followed, the main fuse link in the engine compartment wiring will blow and the vehicle electrical system will become completely inoperative. Have the fuse link replaced by your FORD Dealer if this happens.

If a second battery is connected with 'jumper' cables to your car battery to assist in starting, then the engine of this vehicle should be kept running at a fast idle to keep its own battery charged. After starting the vehicle, do not disconnect the 'jumper' cables until the engine has returned to normal idle speed.

BULB REPLACEMENTS

Headlamps/sidelights

It is possible to replace headlamp and sidelamp bulbs from the inside of the front body section. To change the whole unit, remove the headlamp bezel by taking out the self-tapping screws. Next, undo three self-tapping screws holding the headlamp clamping ring to the headlamp frame, withdraw this ring, and the headlamp may then be eased forwards, exposing the bulbs and the wiring.

Headlamp bulb

Release the bulb by rotating the locating clamp anti-clockwise, then remove the old bulb from the reflector. Hold the new bulb with a clean cloth (to prevent finger contact with its glass); if the bulb glass has been touched, it should be wiped clean with methylated spirits. *Note: the bulb is a standard H4 quartz-halogen item.*

Refit in reverse order.

Sidelamp bulb

Twist the sidelamp's plastic holder anti-clockwise, which allows it, and the sidelamp bulb, to be removed. Refit in reverse order.

Removing the headlamp bezel

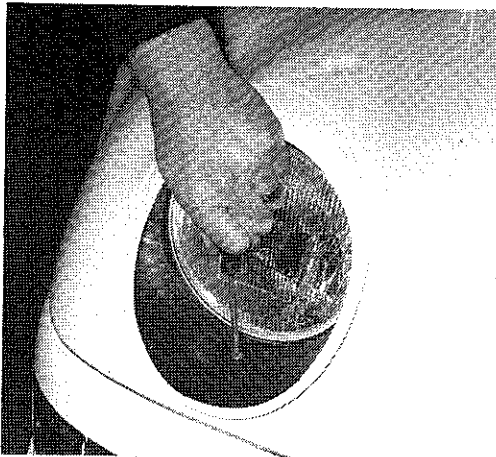

Removing the headlamp unit

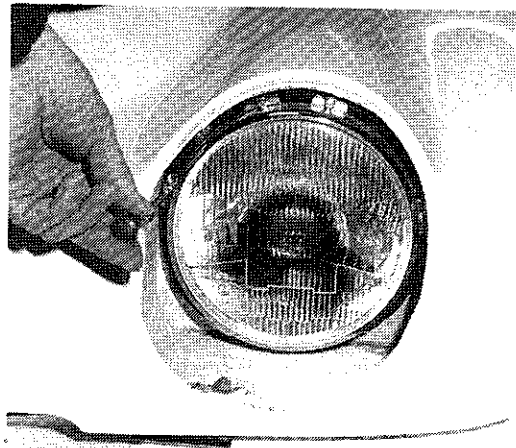

and bulb

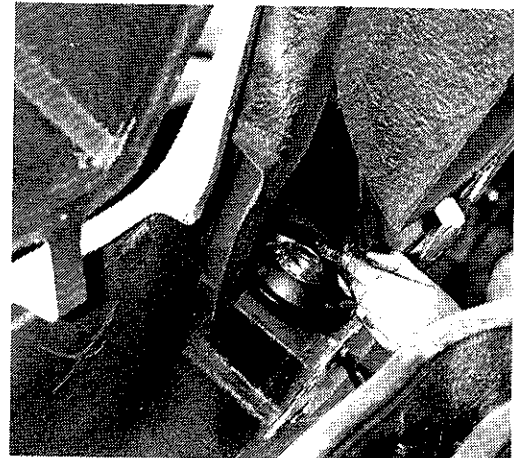

WWW.RS200.ORG

Front fog lamps

These are mounted low down, in the front body moulding, and are mounted on a single, adjustable, pivot, underneath their bodies. Access to this pivot is achieved from inside the lamp unit itself.

To change a bulb, remove the lamp lens clamping ring by taking out one slot-headed screw at the bottom of the ring; the lamp unit, complete with the electrical wiring, may then be eased forwards.

To remove the bulb, ease the rubber sealing gaiter out of position, disconnect the electrical connections, and unlatch the bulb locating spring. As with the headlamp bulb, hold the new bulb with a clean cloth (to prevent grease, from finger contact), or if the bulb glass is touched, it should be wiped clean with methylated spirit.

Refit in reverse order.

Adjustment

After removing the lamp unit from its casing, you will see that the clamping nut is exposed. After slackening this off, the alignment of the lamp itself may be varied. Do not slacken it off too much. After finally tightening up the assembly, and re-assembling the unit, check that it now points in the desired direction.

WWW.RS200.ORG

Front direction indicators

Push the outside edge of the lamp assembly rearwards into the bodywork opening until the plastic retaining clip (E) is audibly locked in the depressed position.

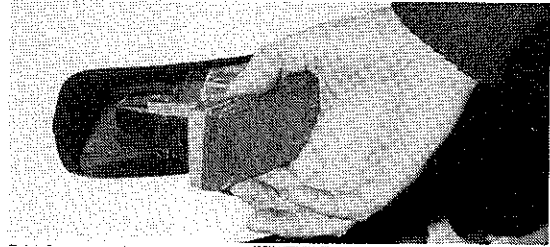
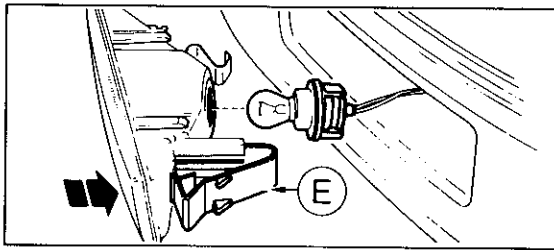

The lamp will then spring forward out of the bodywork opening. When refitting, ensure that the plastic retaining clip is in the released position.

Bulb changing

Turn the bulb holder anti-clockwise, then withdraw it. To remove the bulb, press it in and turn anti-clockwise. Fit a new bulb, and refit the assembly. Bulb type is 12 volt, 21 watt. Push lamp assembly evenly into the bodywork opening, until the plastic retaining clip locks into position with an audible click.

Rear lights

These are accessible from inside the lift-up body section.

To renew a bulb, push tab (1) inwards and remove bulb holder (6) complete with bulbs. Bulbs can be removed by pressing down and turning.

To replace the bulb console, guide bulbs into apertures, then push console into fixture until tab (1) clips into place.

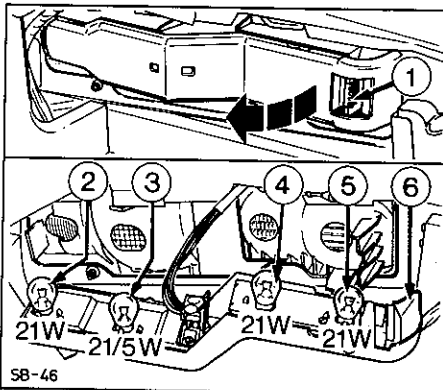

- 2 = Indicator
- 3 = Stop/tail light
- 4 = Reversing light
- 5 = Rear fog lamp

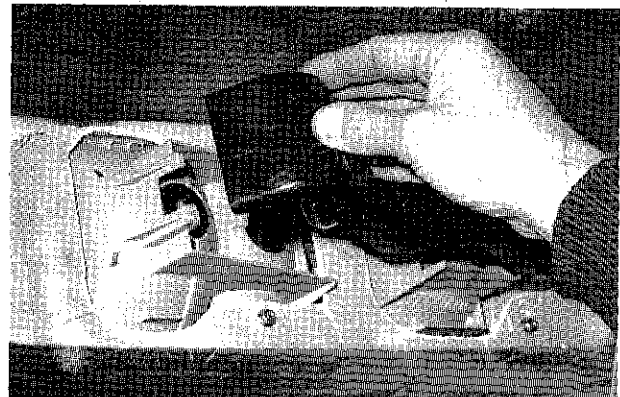

WWW.RS200.ORG

Number plate lights

To renew a bulb, gently prise the light assembly out of the rear bodywork, with a small screwdriver. Turn socket (1) anti-clockwise and remove. The wedge-base bulb is a push fit.

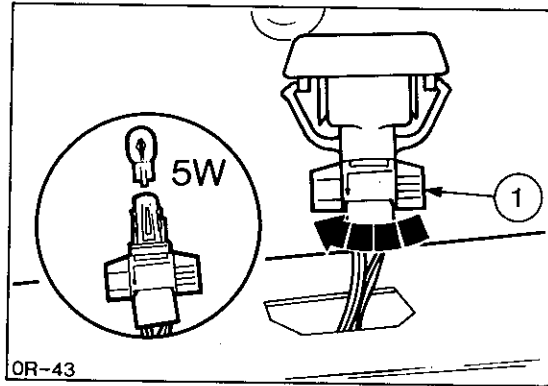

WWW.RS200.ORG

Electrical bulbs fitted to the RS200

From time to time, bulbs need replacement. The following chart lists those most vital to the proper operation of the RS200. In each case, we have quoted the standard bulb's wattage, its FORD Part No., and the Finis Code; when re-ordering, be sure to quote both the Part No, *and* the Finis Code.

All bulbs are 12 volt components:

<i>Bulb</i>	<i>Rating (Watts)</i>	<i>FORD Part No.</i>	<i>FINIS Code</i>
Headlamp	60/55	73EG13009AA	1536494
Sidelamp	4	81AG13466DA	1591848
Auxiliary Driving Lamp	55	69AG13009AA	1496359
Turn Indicator Lamp - front	21	81AG13466AA	6090983
Side Indicator Repeater	5	81AG13465AA	6079730
Stop/tail lamp	21/5	82AG13464AA	6107474
Turn indicator lamp - rear	21	81AG13466AA	6090983
Reverse lamp	21	81AG13466AA	6090983
Rear fog warning lamp	21	81AG13466AA	6090983
Number plate lamp	5	81AG13465AA	6079730
Under front body section illumination	10	81AG13466CA	6090985
Under rear body section illumination	10	81AG13466CA	6090985
Interior lamp (front)	10	81AG13466CA	6090985
Interior lamp (rear)	10	81AG13466CA	6090985
Swivelling map lamp (rear)	5	81AG13465AA	6079730
Auxiliary hazard flasher (rear)	21	81AG13466AA	6090983
Auxiliary tail lamp (rear) as attached to spare wheel mounting frame, <i>inside</i> rear bodywork	5	81AG13465AA	6079730

WWW.RS200.ORG

Fuses and relays

The central fuse and relay box is located behind the stowage compartment in the fascia, which faces the passenger. This is to the left side of the car on right-hand-drive models, and vice versa. The box contains all major fuses and relays. There are two additional relays in the engine management system computer. Having removed the trim panel ahead of the fuse/relay box, to check or renew a component, press the retaining tabs outwards, just sufficiently to allow the plastic cover to be removed from the box itself.

⚠ WARNING—Before touching the fuse box, ensure that the ignition switch, and the appropriate switch are in the 'Off' position. Keep your hands clear of the wiper linkage, as this may return to the parked position when the appropriate fuse is replaced.

All the fuses and relays are a push fit into their housings. Spare fuses, and a simple fuse removing tool are fixed to one side of the fuse box itself. A blown fuse will be recognised by a break in its wire.

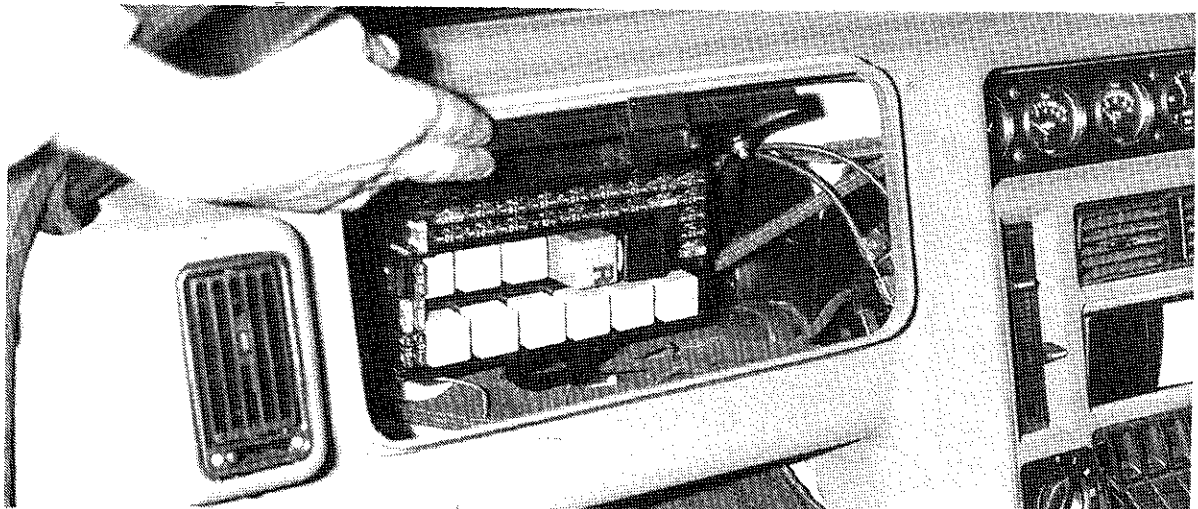
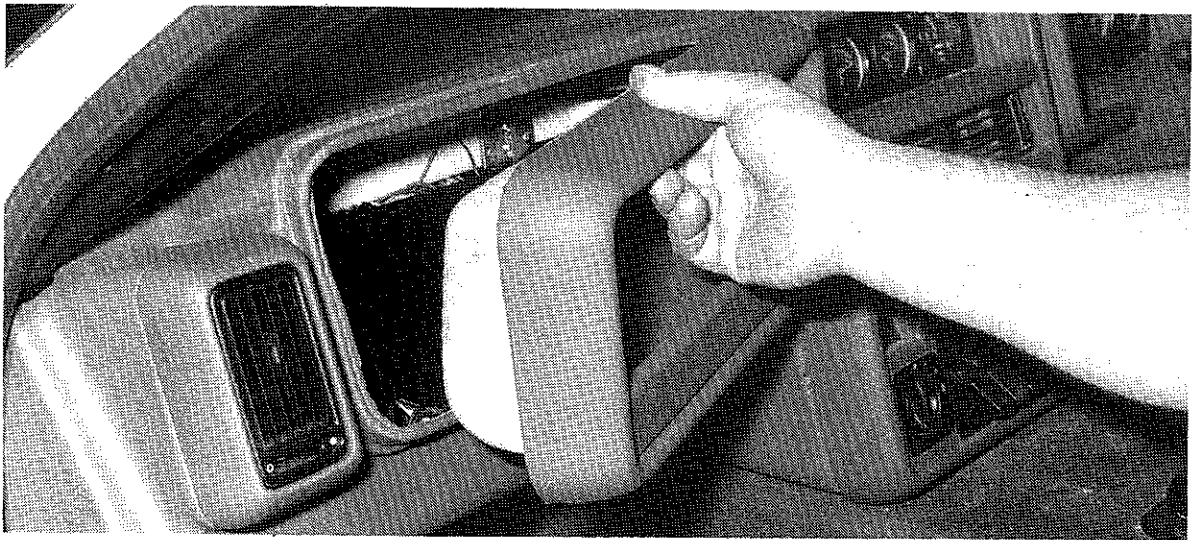

Central Fusebox: Cars with right hand drive or left hand drive

<i>Fuse No.</i>	<i>Fuse Rating</i>	<i>Circuit Protected</i>
1	25	Heater blower motor, windscreen washer pump
2	10	Brake lights, reversing light
3	10	Windscreen wiper motor
4	10	Indicators
5	10	Clock, headlamp flashers, Instrument illumination, switch illumination
6	10	Engine management system computer
7	15	Horn
8	10	Spot light (left - if used)
9	10	Spot light (right - if used)
10	10	Fog light (left, apron, low)
11	10	Fog light (right, apron, low)
12	10	Long range light (left - if used)
13	10	Long range light (right - if used)
14	10	Main beam left
15	10	Main beam right
16	10	Dipped beam left
17	10	Dipped beam right
18	10	Side and tail lamps, left
19	10	Side and tail lamps, right
20	10	Radio, and Intercom systems (if fitted)
21	20	Interior lights, reading lights, clock
22	25	Radiator cooling fan

Fuse colours, with ratings

10 ampere - red, 15 ampere - blue, 20 ampere - yellow, 25 ampere - clear, 30 ampere - green.

If a circuit should still be defective even though a new fuse has been fitted, or if the new fuse blows as soon as the circuit is switched on, then have the respective circuits checked by a FORD Dealer.

Layout of fuses and relays

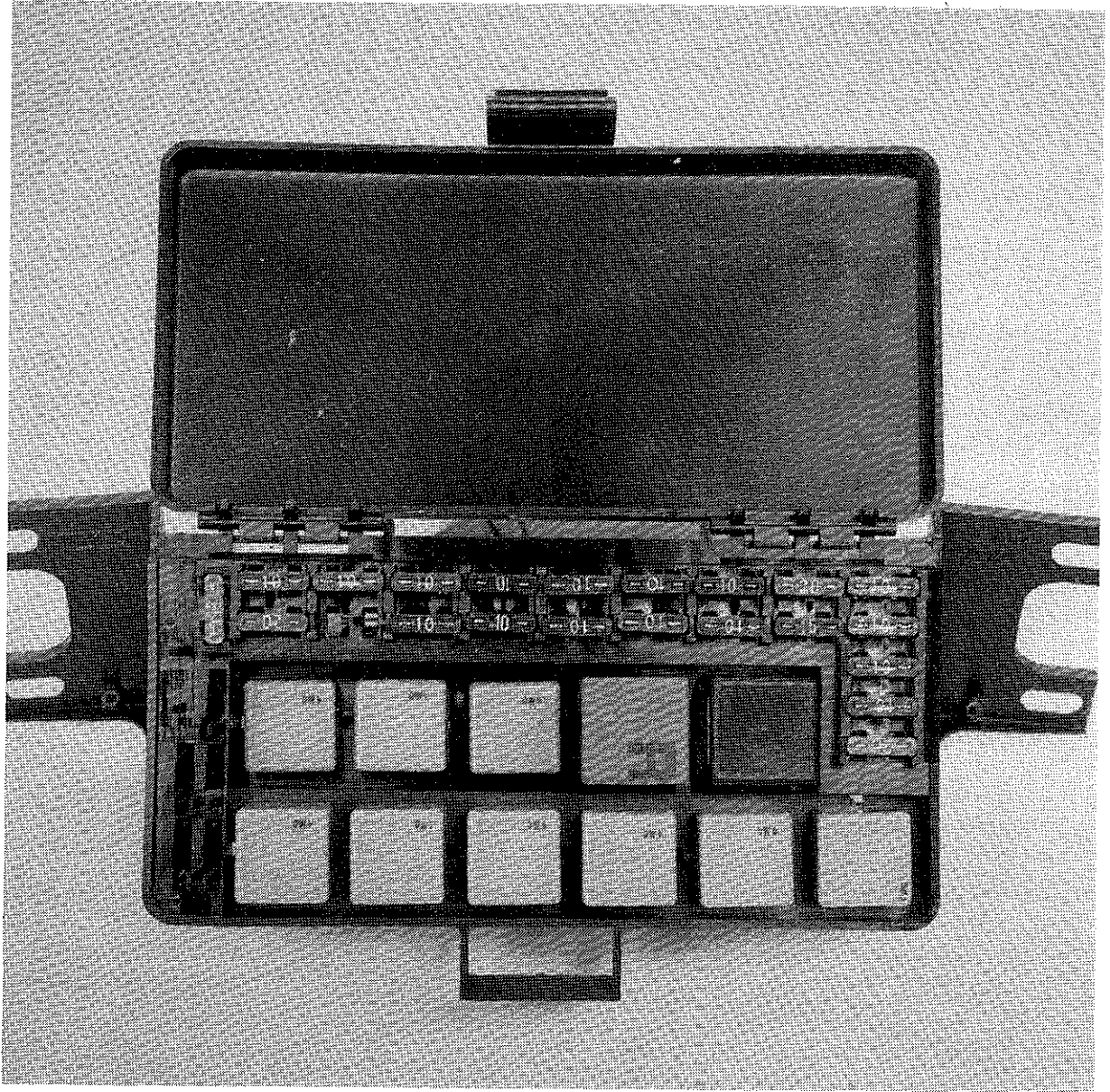

WWW.RS200.ORG

Relays in central fusebox: Cars with right hand drive or left hand drive

Relay No.	Symbol	Switched circuit
A	(40 A)	Main beam headlamps
B	(40 A)	Dipped beam headlamps
C	(40 A)	Spot lamps
D	(40 A)	Fog lamps
E	(40 A)	Long range lamps
F	(40 A)	Radiator cooling fan
G	(IND)	Direction indicators
H	(WIP)	Windscreen wiper motor
I	(40 A)	Ignition switch
J	(40 A)	Horn

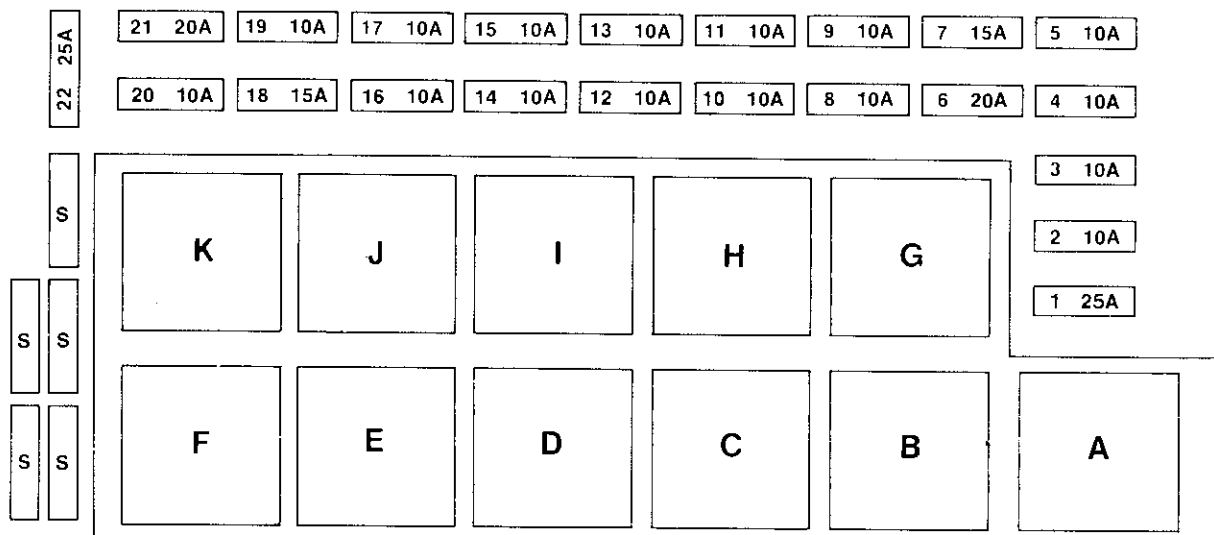

Relays associated with engine management system computer

Three relays are fitted close to the engine management system itself. The Computer itself is fitted on the rear passenger bulkhead, behind the left hand seat.

The relays are positioned on the engine side of the same bulkhead.

Drive belt adjustment

There are two drive belts on the RS200's engine, at the rear, facing the oil tank/header tank support sub-frame.

The drive belt to the twin overhead camshafts is adjustable by re-locating the eccentric adjustment pulley (see SPECIFICATION, EQUIPMENT, and COMPONENT CHANGES), and this involves removing the protective cover.

Adjusting the alternator drive belt

Correct belt adjustment is important, to ensure adequate belt life, and to avoid belt slipping. Therefore, have the belt tension checked regularly by a FORD RS Dealer, and corrected as necessary.

⚠ *WARNING—When the engine is running, be sure that none of your clothing, such as a necktie, or a scarf, becomes caught up in the moving drive belt.*

⚠ *Before loosening the alternator fixings, and adjusting the alternator belt tension, the battery MUST be disconnected.*

The belt tension can be set by adjusting the reach of the alternator strap. The tension is correct, when checked at the mid-point on the stretch between the exhaust camshaft pulley and the engine cover idler, when the total lateral play is 20mm (0.75in.) under normal finger pressure.

[Using a Burroughs gauge, the tension should be between 75 and 80 Burroughs Units.]

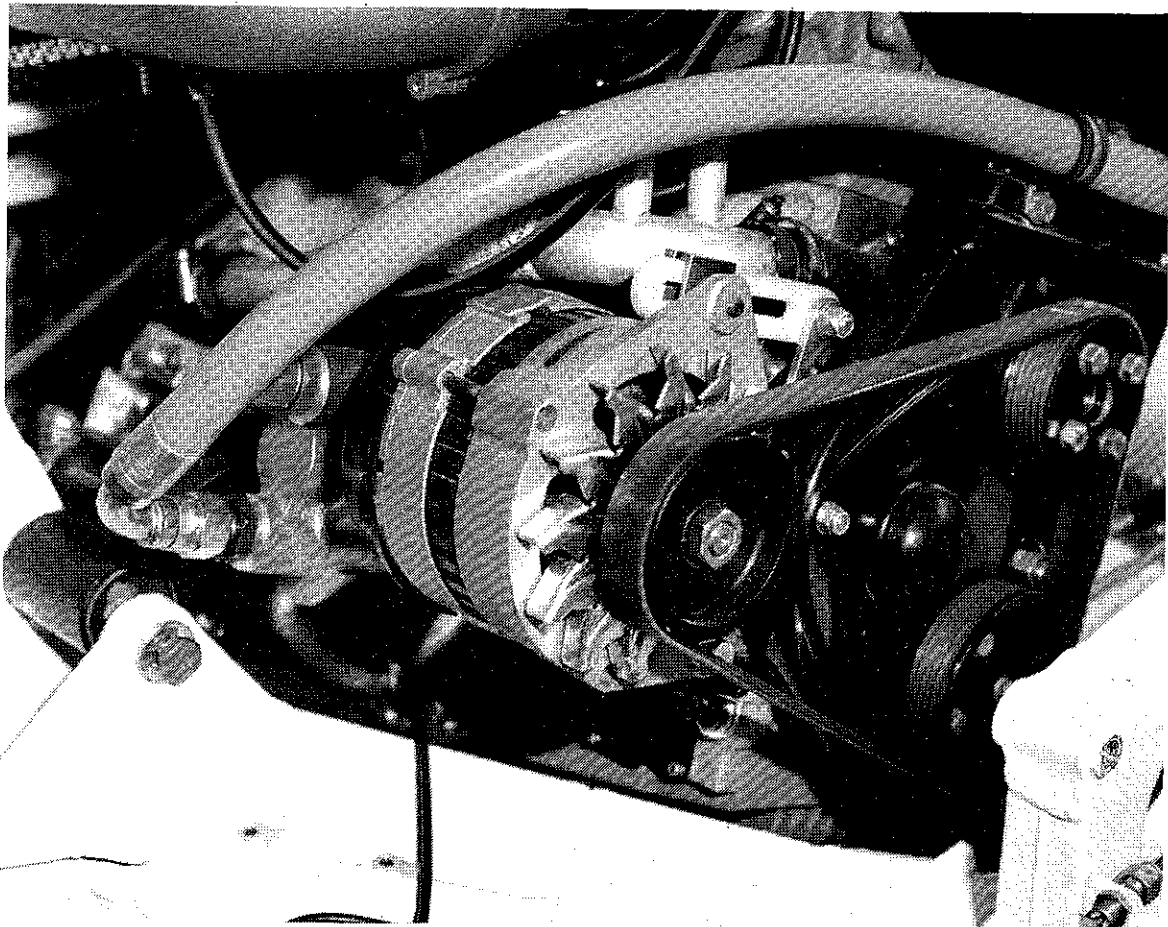

WIPER BLADES

Checking condition of wiper blades

The rubber edges of the wiper blades are subject to hard usage and wear. Our tip:

Renew them once or twice a year. The rubber blades can be damaged by contact with materials such as car cleaning agents, grease, silicones or fuel. It is therefore recommended that the wiper blades and windscreen are regularly cleaned using only Motorcraft Cleaning Paste. In frosty weather the wiper blades should be hinged away from the window when the vehicle is parked.

Wiper blades/arm replacement

When replacing a wiper blade, press to disengage the spring clip and then pull the wiper blade off the wiper arm.

To remove the wiper arm, swing it away from the screen and lift the plastic cap 1 (or, on some models, lift off the hinged cover 2). Remove the nut and washer and pull the wiper arm off the drive spindle. The Motorcraft range offers recommended replacement wiper blades and arms.

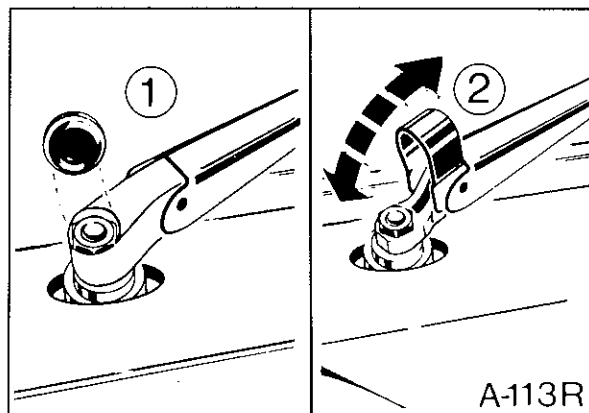
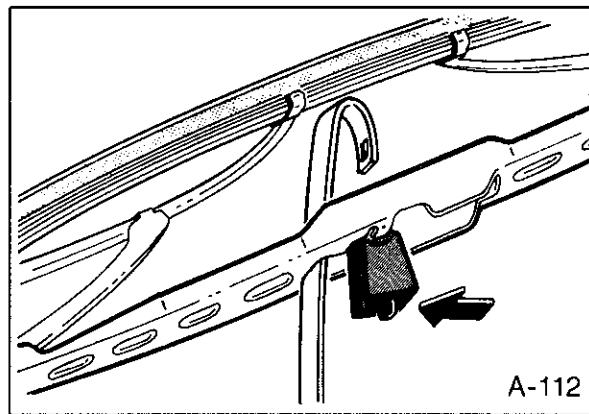

Windscreen washer jet adjustment

If the water spray from the jets to the windscreen is not accurately adjusted, this may be re-adjusted as follows:

The RS200 has ball-adjusting nozzles. Place the point of a pin into the nozzle, and swivel it to the required position.

Each nozzle position has two separate, independent, ball-adjusters.

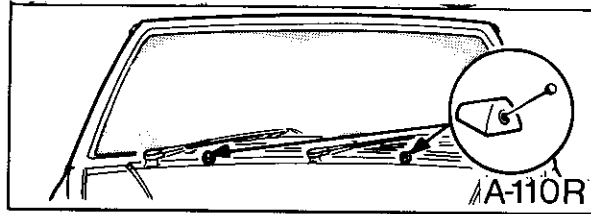

WWW.RS200.ORG

FAULT FINDING AND DIAGNOSIS

How do you find a fault?

Your RS200 has been manufactured with the aim of simplifying service and maintenance. Regular care and service will ensure that it remains in optimum condition. However, in case you ever have a problem with your car, the next section should help you find out what is wrong, and perhaps you will be able to rectify the problem.

Text in normal print means: You can carry out the repair yourself and have it checked by a FORD RS Dealer at a later date.

Text in bold print means: The repair should only be carried out by a FORD Dealer.

WWW.RS200.ORG

<i>Symptom</i>	<i>Check for:</i>
Starter motor does not turn	<ul style="list-style-type: none"> • Flat battery
Headlights do not come on	<ul style="list-style-type: none"> • Loose or dirty battery connections
Starter motor does not turn	<ul style="list-style-type: none"> • Battery charge low
Headlamps dim	<ul style="list-style-type: none"> • Loose or dirty battery connections • Starter motor pinion not engaging • Seized engine
Starter motor does not turn	<ul style="list-style-type: none"> • Loose, dirty, or detached connections in starting circuit
Headlamps are bright	<ul style="list-style-type: none"> • Starter motor jammed in mesh • Defective starter, starter solenoid or ignition switch
Starter motor turns but does not engage	<ul style="list-style-type: none"> • Loose, dirty or corroded battery terminals or engine earthing strap • Defective starter, or starter solenoid • Starter motor pinion dirty
Engine turns slowly but will not start	<ul style="list-style-type: none"> • Battery charge low • Wrong grade of engine or transmission oil
Engine turns but will not fire or engine runs erratically	<ul style="list-style-type: none"> • Fuel tank empty, or near empty • Defective engine management system • Dampness on spark plugs, HT leads, or ignition coil • Dirty or loose connection of HT leads to coil and engine management system computer. • Spark plugs badly adjusted or 'oiled up'. • Blockage in injector jets, or fuel line, or • Fuel pump inoperative.

WWW.RS200.ORG

Engine idles, but stalls when accelerator depressed

- Blocked, or very dirty aircleaner
- **Defective engine management system**
- **Partial blockage in fuel lines**
- **Partial blockage in fuel pumps**

Engine accelerates poorly, misfires, or lacks power

- **Defective engine management system**
- **Defective turbocharger**
- **Spark plugs badly adjusted, or 'oiled up'**
- **Incorrect valve timing and valve clearance**
- **Blockage in fuel injection system**

Engine runs on when ignition switched off

- Engine overheating/coolant level low
- Wrong grade of fuel used
- **Spark plugs overheating, and causing detonation, wrong type fitted, or incorrectly adjusted**

Engine does not reach normal operating temperature

- **Faulty thermostat**
- **Faulty water temperature gauge or sensor**

Engine overheats or temperature gauge reads excessively high

- Low coolant level
- Hoses split or detached, or hose clips loose, causing leaks
- **Defective thermostat**
- **Defective water pump**
- **Defective engine management system**
- **Faulty water temperature gauge**
- **Faulty temperature gauge sensor**
- **Electrically operated cooling fan defect (or faulty thermostat control)**

Electrical systems inoperative

- Loose or dirty battery connections
- Flat battery
- Fuse blown for a particular circuit **(if a replacement fuse also blows, consult your nearest FORD dealer)**
- **Fuse link connecting main loom to battery battery blown.**

Direction indicators inoperative

- Fuse blown (if the replacement blows again, consult your nearest FORD Dealer.)
- Indicator relay inoperative
- Direction indicator switch defective

Bulbs repeatedly burn out

- Faulty connections at light socket
- Circuit overload
- Alternator regulator defective

All lights dim when engine speed drops to idle

- Loose alternator drive belt
- Battery charge is low
- Alternator not charging correctly

Ignition warning light comes on when engine is running

- Fuse blown
- Alternator drive belt loose, or broken
- Alternator defective

Oil pressure warning light comes on when engine is running above 2000 RPM

(Oil pressure gauge shows low reading)

- Oil level below 'MIN' mark on dipstick
- If oil level is correct, and Pressure is still faulty, consult nearest FORD Dealer before re-starting the engine.
- Oil pressure switch defect. (Not if gauge also reads low)

Brakes feel spongy

- Air in hydraulic system
- Leak in brake system

Excessive brake pedal travel

- Failure of one hydraulic circuit
- Air in hydraulic system
- Leak in hydraulic brake system

WWW.RS200.ORG

Brakes judder

- **Badly worn brake pads, or disc surfaces**
- **Incorrectly assembled brake caliper components**
- **Oil or fluid contamination on pads or discs**

Brakes require excessive pressure

- Water on brake pads and discs
- **Failure of one hydraulic circuit**
- **Seized caliper cylinder**
- **Defective master cylinder**
- **Wear/friction in pedal/balance bar assembly**

Car becomes heavy to steer

- Tyre pressures too low
- **Wheel alignment faulty**
- **Steering rack adjustment deranged**

Difficulty in engaging gear

- **Idle speed too high**
- **Clutch adjustment faulty**
- **Defective transmission**
- **Defective clutch**
- Cold transmission (after overnight halt)

Clutch slips - car does not accelerate

- **Oil or other contamination on clutch disc faces.**
- **Worn-out clutch**

Uneven tyre wear

- Tyre pressures not as specified
- **Faulty wheel alignment, at front *and* rear**
- **Wheels need balancing**
- **Mis-alignment of suspension due to accident damage**

Car pulls to one side

- Tyre pressures unbalanced, at front or rear
- **Uneven tyre wear, or mixed types of tyres in use**
- **Incorrect brake adjustment**
- **Oil, water, or other contaminant on brake discs**
- **One or more brake calipers defective, or with seized cylinders**
- **Wheels out of alignment**
- **Chassis out of alignment after accident damage**
- **Defective/seized wheel bearing**

WWW.RS200.ORG

Car wanders at speed

- Tyre pressures incorrect
- **Incorrect wheel alignment, front or rear**

Car vibrates when driving along

- **Wheel nuts loose**
 - **Wheels out of balance**
 - **Inoperative shock absorbers allow-excessive wheel movement**
-

What to do when ...?

If you do break down, switch on the hazard warning flashers and if available, suitably position the warning triangle to indicate the danger.

WWW.RS200.ORG

DRIVING THE CAR 05

WWW.RS200.ORG

Index

	Page
Guidelines on Starting the Engine	2-3
Braking, and the Dual Hydraulic System	4-5
Driving Methods	6-8
Winter Motoring, Towing and Roof Racks	9

GUIDELINES ON STARTING THE ENGINE

Although the RS200 is fitted with a very high-output turbocharged engine, this is controlled by an electronic engine management system. Starting the engine, therefore, is no more complex than with ordinary saloons.

Before trying to start the engine:

⚠ WARNING—Do not use loose floor mats which may restrict the operation of the pedals, or hinder your own foot actions.

Before starting, make sure that the handbrake is applied.

Ensure that the gear lever is in neutral.

If starting the car in a garage, or other enclosed space, ensure that a door is left open, so that exhaust gases (which contains carbon monoxide, which is odourless and invisible, but highly poisonous) can escape.

Starting the engine from cold

There is no manual choke control on the RS200. The adjustment of the fuel/air mixture, to take account of engine temperature and atmospheric conditions, is automatically set and monitored by the electronic engine management system.

It is advisable to depress the clutch when starting from cold, as this will reduce transmission drag, and allow the starter to spin the engine at a faster rate.

Do not depress the accelerator.

Turn the ignition key to position III, and the engine should start.

If the engine does not start, return the key to position I, pause, and repeat the operation.

If the engine still does not start, return the key to position I, pause for a few seconds, then proceed as described in 'Starting a Flooded Engine'.

Once the engine has fired up, allow it to warm through, gently build up the engine revs, and let the clutch pedal return to the normal, engaged, position. Do not attempt to drive the car away from rest as soon as the engine has fired up. Because there are relatively large volumes of lubricant in the engine and transmission assemblies, it is advisable to let these lubricants warm up – especially after an overnight 'cold soak' – before driving the car.

With the transmission in neutral, and with the clutch pedal in the normal, engaged, position, allow the engine and transmission to warm up, at a fast idle. Then, for the first six miles/10 kilometres or so, drive gently, with slow gear changing, so that all working surfaces free-up properly, and remain correctly lubricated until the temperature gauge reaches 60° it is not advisable to exceed 3000 RPM.

Starting with a hot engine

Because of the sophisticated nature of the electronic engine management system, there is no difference in starting procedure, whether the engine is hot or cold. For starting a hot engine, proceed as for 'Starting with a Cold Engine'.

Starting a 'Flooded' Engine

If the engine has been cranked over several times without starting up, the induction system may have become 'flooded'.

The starting procedure after this, is as follows:

Depress the accelerator pedal fully to the floorboard, hold it there, and crank over the engine for approximately 5 seconds by actuating the ignition key to Position III with plugs and fuel pump relay removed.

Stop cranking. Release the accelerator pedal. Replace plugs and relay. Then proceed, as for a normal start.

Stopping the engine, after a Fast Run

When the RS200 engine has been worked hard for a period of time, the turbocharger becomes extremely hot.

Do not stop the car and switch off the engine immediately; this imposes heavy thermal stresses on the turbocharger.

After stopping, allow the engine to idle for 20-30 seconds, to allow the exhaust gases to cool down, the turbocharger to accustom itself to lower thermal inputs, and the turbocharger bearings to recover. Then switch off in the normal way.

Running-In - from new

There are no particular running-in rules for your new FORD RS200, but we recommend that you go easy on the car, and not work it to its limits, for the first 1500 km (1000 miles).

By driving the car reasonably, you will be investing in the optimum service life, power, and overall performance from the engine and the transmission.

Avoid constant-speed operations for the first driving period. Varying speeds will assist all components to 'bed in' quickly, evenly and correctly.

Avoid consistently high speeds, over-revving, or straining the engine. Rather change gear too often, than too little.

Run in new tyres for the first 150 km (100 miles), by not driving them at high speeds, and by avoiding sharp cornering, harsh acceleration, or sudden braking.

As far as possible, avoid heavy braking during the first 150 km (100 miles) in city traffic, or the first 1500 km (1000 miles) on high-speed motor roads, so that brake pads have time to 'bed-in' evenly, and reach their optimum wear and friction values.

Running-In - after a major rebuild

After a major rebuild, much of the RS200 may be new, and we advise that you treat the rebuilt machine as a new car for the first few hundred miles after it returns to the road.

Do not tackle a long journey straight away, after the rebuild is complete.

Treat the first two or three short journeys as test drives, so that you can be sure all systems are functioning correctly.

In particular, ensure that all the cooling, hydraulic, oil, and electrical circuits are working correctly. After the first runs, double check that there are no fluid leaks, and take an early opportunity to re-check the steering and suspension geometry - front *and* rear - of the rebuilt car.

WWW.RS200.ORG

Braking, and the Dual Hydraulic System

The RS200 has a powerful braking installation, suitable not only for controlling the high performance of the road car, but forming the basis for use when the car is entered in competitions.

Big ventilated disc brakes are fitted at front and rear. The foot brake operates dual hydraulic circuits - separate front-wheel and rear-wheel systems. This means that, should one of the circuits fail, the other circuit remains operative.

There is also an efficient handbrake system, with the lever (which is positioned between the seats) linked by cable to separate calipers on the rear brake discs.

Dual circuit operation

Each hydraulic system has its own master cylinder, mounted ahead of the driver's footwell, and its own reservoir. Each of the braking system reservoirs is equipped with an electric level sensor, which triggers a warning light on the instrument panel if the level falls below its safe limit.

The two master cylinders are operated from the foot pedal by means of a fixed action balance bar. Should one of the brake circuits fail, this design ensured that the other circuit remains operative. The feel of the brake pedal will be different, and you will need to apply more braking force to achieve the same retardation, but some braking power remains.

In this event, you should go immediately to your nearest FORD RS dealer, taking appropriate care with a car having reduced braking abilities, and have the problem rectified.

Handbrake

The handbrake lever is situated on the transmission tunnel, between the front seats. To apply, pull the lever firmly upwards. To release it, lift the lever slightly, depress the button, then ease the lever fully down.

There is a warning light on the instrument panel display which illuminates if the handbrake is in the ON position. This light only shines when the ignition circuits are switched ON.

The handbrake operates on a pair of calipers on the rear discs, which are quite separate from the footbrake calipers. Unlike the footbrake the handbrake is not self adjusting and it will be necessary to carry out adjustments if the handbrake lever movement becomes too excessive.

Footbrake adjustment

No adjustments are normally necessary, as both the front and the rear brakes are self-adjusting. However, as the pads wear down, the level of fluid in the brake reservoirs will fall. Keep a careful check on these levels, and top up as necessary.

Rear brake sub-assembly

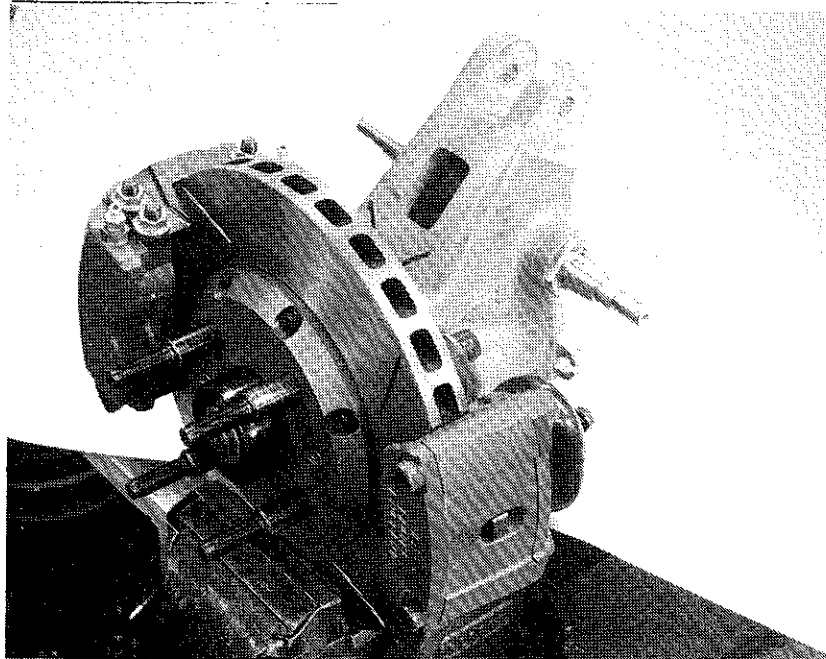

Use of brakes

Brake wear in the RS200 is largely dependent on your driving methods, and operating conditions, particularly regarding dusty surfaces. Frequent braking and hard or erratic driving will result in abnormally rapid brake pad wear.

Occasionally your car's brakes may squeak, squeal, or make other unexpected noises. This sometimes depends on atmospheric conditions, or on the state of the discs themselves. Normally this is not a function fault, but may be caused especially after prolonged use over surfaces which might have thrown up grit, or encouraged deposits to form on the disc surfaces themselves.

Your brakes will not be fully effective if the discs themselves are wet. Water reduces friction, and delays the braking effect, so it is always advisable to test the brakes gently when starting a journey, and to keep a greater distance between yourself, and the car ahead of you, in heavy rain, or slush.

After travelling through fords, or standing water, and after washing the car, you should operate the brake and throttle simultaneously while driving away, over a short distance, to rapidly dry and disperse any film of water that might have formed on the brake discs.

Good drivers have a 'feel' for their cars, and never over-use their brakes. This reduces pad wear, and encourages fuel economy at the same time. Heavy braking should only be used when there is a real emergency.

As far as possible, 'bed-in' new sets of brake pads by avoiding heavy braking during the first 150 km (100 miles) of city driving, or the first 1500 km (1000 miles) of motorway driving.

Brake pad replacement

All pads on the RS200 may be inspected without dismantling the brake. The pads should be replaced when there is less than 2 mm of material remaining on the back plate. (See SPECIFICATION and EQUIPMENT.)

Brake fluid replacement

Brake fluid is hygroscopic, which means that it tends to take in moisture from the air over a period of time. Water-affected brake fluid has a reduced boiling point, and on such a fast car as the RS200 this should not be tolerated.

The presence of water also helps corrosion to start in the braking system.

Therefore the brake fluid should be changed at the intervals specified in the SERVICE section of this manual, if the brakes are to continue to function efficiently.

If the brakes are frequently used in mountainous areas, or by driving the RS200 to its limits off the public highway, the brake fluid should be renewed every time the brake disc pads are changed.

 **WARNING**—If the fluid, for brake or clutch, is spilled on paintwork at any time, the affected area must be washed down with cold water immediately, or corrosion will begin.

Tyre pressures

Check the tyre pressures regularly (including the spare wheel) - and ensure that these are maintained at the recommended levels.

For normal road use, ensure that the pressures do not fall below recommended levels. There are no advantages to be gained by over-inflating the tyres. This does not improve the roadholding, and it reduces ride comfort.

At the filling station

Try to get a feel for the usual fuel consumption achievable by your car. We recommend that you keep a careful check on this, and if the consumption increases significantly, check out the car for fuel leaks, or any deviation from normal settings.

For regular service attention, see your FORD RS Dealer.

Driving methods

The FORD RS200 is a specialised, high-performance, road car, and you should always take pride in driving it smoothly, and sympathetically, at all times. Properly set-up, and maintained, the RS200 is one of the fastest and safest cars in the world.

Three-times World Champion racing driver Jackie Stewart has been closely involved with the development, and test driving, of the RS200, and offers these views, and tips, about the best way to treat your RS200:

'Even when starting up the car, keep in mind that you are in a high-performance vehicle. Size for size, it is a faster car than would have been taken to the Le Mans 24 Hour race not too many years ago. It's a highly bred thoroughbred.

Any performance engine of this type requires some pampering, particularly when starting up from cold. Overnight most of the oil will have settled away from the top of the engine, and you have to get all that cold oil circulating again, before you set the car to work.

The same advice applies to the transmission.

Start up the engine lightly, without giving it any engine revs. Give it a nice, slow, warm-up, and don't pulsate the engine revs up and down - don't go Whang, Whang, Whang on the throttle pedal. Give it time to warm through - ease it into its day in a gentle fashion - and once the temperature gauges start to register, prod the throttle pedal lightly, once or twice only, to give the spark plugs a chance to be clear.

The transmission will certainly feel better when warmed up. It is designed with competitions in mind, and has a competition clutch, so it will never feel as sweet, and easy to use, as that of a Sierra or a Granada/Scorpio. In fact you may find that it is a little difficult to engage gear when the transmission is cold. You may also find that you crunch the change from first to second gear at times - don't think that's anything to be ashamed of, because Jackie Stewart crunches it as well!

Now, what about use of engine revs?

'This really is an amazingly 'torquey engine'. I can feel the turbocharger effect from about 2,500 rpm, and then it pulls smoothly all the way up to the rev-limiter.

I tend not to take the engine much over the 6,000 rpm mark, and I have usually changed gear at 5,000 to 5,500 rpm. I use fifth gear much of the time. Even when I have been driving slowly around the country lanes, I still keep it in fifth gear, for it shows no signs of temperament.

Which leads me to mention the instrument gauges. They are all well-displayed, and the rev-counter/tachometer is larger than the speedometer, which is right for what is a semi-competition car. You will see that all the gauges have clear markings, and you should try to get used to the nominal, or optimum, readings, which are listed elsewhere in this Manual.

Any good driver, like a good pilot, has to pay attention to his instruments on a regular basis. That's something that only training, and perseverance, can ensure. For quick reference you should know where all the red needles should be pointing, once the car is warmed up, then nothing more than a quick glance around is needed.'

Because there is a choice of transmission modes, we also asked for advice on this:

'I have always thought of the RS200 as a four-wheel drive car which just happens to have a rear-drive option as a bonus. The large majority of people who purchase this vehicle will have competitions in mind, where the four-wheel-drive configuration is ideal. Certainly for rallying, and even while using the car on the road, in a variety of conditions, they will see the purpose and novelty of it, with great traction, and most will take full advantage of this.

The car is very well-balanced - we spent a lot of time on that aspect of the design - because it has only one third of the torque normally fed to the front wheels, which also have to deal with steering efforts.

I would not recommend use of the centre differential lock - which gives a 50/50 per cent torque split between front and rear wheels - except in extremely slippery conditions, such as mud, or snow and ice.

The ordinary four-wheel-drive configuration is so very good in almost all conditions that you will never need to use the diff. lock unless the grip really is minimal.

However, the good news is that whenever I have used the diff. lock, even on hard tarmac/asphalt surfaces, I have found that the handling balance was as good as ever, perhaps even slightly better if I was getting a wheel off the ground at one corner!

Two-wheel-drive - rear-wheel-drive only, on this car - may give a slight advantage in some tarmac competitions conditions, and it may give some slight fuel economy advantage on long journeys, but when using the RS200 as an exhilarating road car the normal four-wheel-drive configuration is ideal. I rate the RS200 as the best-balanced four-wheel-drive vehicle I have driven, so far.'

What about those drivers who love to tinker with a car's settings?

'People like to tinker, and they think they know a better way, but I don't recommend any of that, with this car. If you start to play with it, you will change the basic characteristics of the machine, and that's not to your advantage if something goes wrong, or some on-the-road crisis develops.

I feel that the engineers have achieved the best overall balance, and the best roadholding for normal road use. All of us have tried to produce a car which is safe in any circumstances.

There is tremendously good straight-line stability, good road feel, and good centre feel. Part of this is due to the suspension geometry we have worked out for the car, and to the careful attention to tyres and ride heights. The good stability is also partly due to the use of a reasonable amount of castor.

Personally, I think that unless the car is to be used in competitions, the owner should not divert from the chosen road-car settings, all of which are listed elsewhere in this Manual.

That advice also applies to the tyre pressures, which are recommended at 2.0 Bar/29 psi front and rear. If you over-inflate the tyres, they don't work any better, and all you will do is to wear out the centre of the tread. The tyre wear is very even, for the 'footprint' on the ground is nearly ideal.

The tyres, of course, have a 'VR' rating, which means that they can be used for cars which regularly exceed 130 mph. The RS200 road car certainly does that - I have driven it at close to 150 mph, and at that pace it still feels very stable.'

Jackie also wanted to emphasise the car's competitions origins:

'Because the car has four-wheel-drive and, in my opinion, merits a fair-degree of self-centring for stability, the front suspension has a lot of castor.

This means that steering efforts are going to be relatively high, especially as we have big fat tyres too.

Anyone who buys the car will realise its specialist nature, and he will come to accept that while parking the car, or manoeuvring it in tight spots at low speeds, a considerable effort is needed.

Don't be put off by this. I keep reminding everyone that it is basically a competition car - and I recall trying to turn a Formula 1 car at low speeds, and that has very little weight, up front.

At normal driving speeds, however, the steering efforts are much lighter, and completely acceptable.

Now, brakes. There is no need for a servo on the RS200, the pad area is generous, so the pressures needed are quite heavy. Bear in mind that a firm feel is much more important on a car like this, than very light pedal pressures.

Incidentally, after any hard driving on a bumpy, rocky, road, it is a good safety tip to check the position and 'feel' of the brake pedal again before you need it in earnest. That's especially true at the start of the day's motoring, or after any session where flying stones might have caused a brake leak that you didn't know about.

In cars, by the way, I'm sure that most of us are not nearly as careful, or as conscientious, as airplane pilots are. We should be. It is very good practice to have a cockpit check, before you drive away.

The RS200, of course, has had to make some compromises. It has to be basically right for competition, and it also has to be an acceptable road car. I think that customers will soon know that they have a very precise-handling, very agile, and very fast road car, but they should also come to terms with some characteristics of this thorough-bred.

However, there is certainly more transmission noise than on a conventional two-wheel-drive car - more splines and universal joints, for instance - so don't be alarmed to hear this on your own RS200. They will all be like that.

The big advantage of four-wheel-drive, for ordinary motorists not intending to enter their cars for competition, is that it gives so much traction. It seems to be able to get out of almost any cornering situation, and to pull itself out, under power. I certainly think it reacts more positively, in cornering, than any other car I know.'

Turbocharger wastegate 'flutter' - what does the noise mean?

When you learn to drive the RS200 fast, you will encounter a turbocharger control noise called 'wastegate flutter.' Although this sounds worrying at first, it is a perfectly normal function of the system, and is nothing to worry about.

As the engine reaches full turbocharger boost, the extra pressure generated by the turbocharger is automatically limited to 0.75 Bar/11.0 psi. At this point, the wastegate control opens - literally, to 'dump' the extra pressure which might otherwise be generated, and this leads to a fluttering noise from the region of the turbocharger.

[This is more obvious to the driver of a right-hand-drive RS200, than a left-hand-drive car, as the wastegate control is mounted in the engine bay, directly behind the line of the right-hand seat].

The advent of the 'flutter' does NOT mean that anything is wrong with the engine. It actually means that the turbocharger boost control devices are doing their job in the prescribed way.

Even though the RS200 has extraordinary roadholding abilities, we also make these recommendations:

Cornering

Avoid gearchanging or braking on corners, especially on wet or icy roads, and try to 'straighten' bends as much as you can. Corners should ideally be taken under gentle acceleration - especially with this car, do not lift-off abruptly in mid-corner.

Braking and stopping

Erratic driving is heavy on fuel and causes unnecessary wear of brakes and tyres. Observe the density of traffic ahead, and maintain a suitable distance from the vehicle in front. Slow down naturally with the minimum use of the brakes.

On slippery, or other low-friction surfaces, remember that the traction of the RS200 available for acceleration may be considerably greater than the retardation available from the brakes. Remember that although you can get away from a halt faster than almost any other car, and you can attain higher speeds on low-friction surfaces, you cannot stop any quicker!

Winter motoring

- When winter temperatures prevail, use FORD or Motorcraft Super Motor Oil SAE 10W-30 and make oil-changes at shorter intervals if your driving is mainly short-distance.
- Check the cooling system for leaks (see section 'REGULAR MAINTENANCE AND CARE') and have the antifreeze solution checked for strength.
- Fill the screen-washer reservoir(s) with a mixture of clean water and Motorcraft Windscreen Washer Fluid and if necessary with antifreeze protection. Operate the system several times immediately. Check the condition of the windscreen wiper blades which should be replaced if there is any evidence of wear. (See section ROADSIDE EMERGENCIES).
- Is the battery charge alright? If in doubt, have the condition of the battery checked by your FORD Dealer.
- Thoroughly hose down the underside of your vehicle frequently to minimise the effect of salt deposits or at least when the wintry conditions are over.
- Check the condition of the tyres.
- Fit snow chains when necessary. (See section under 'TYRE CARE').
- In an emergency, frozen door locks can be freed by inserting a heated key in the lock cylinder. A Motorcraft de-icer works better and faster. Door lock cylinders require lubrication after de-icer has been applied. For full details, please refer to 'Locks, Hinges and Catches' in the section. 'REGULAR MAINTENANCE AND CARE'.
- Consult your FORD Dealer if your engine appears to be running at an excessively high or low temperature.

Towing a trailer

As the RS200 is a specialised vehicle, it is recommended that it should not be used for towing a trailer of any kind.

Roof racks

As the RS200 is a specialised vehicle, it is not recommended that a roof rack should be fitted.



RS 200

SUPPLEMENTARY OWNER'S MANUAL

Supplement to Section 06
Regular Maintenance and
Care containing Service
Schedules for:—

- Pre-delivery Inspection
- First Service
- Interim Service
- Standard Service
- Extended Service
- Torque Specification
- Chassis Dimensions (Type approved)
- Spark Plug Details 07-03
- Bump-Steer Checks
- EEC IV Fault Diagnosis Chart

The technical information, data and descriptive text in this issue, to the best of our knowledge, were correct at the time of going to print. The right to change prices, specifications, equipment and maintenance instructions at any time, without notice, is reserved as part of Ford policy of continuous development and improvement.

No part of this publication may be reproduced, stored in a retrieval system or transmitted in any form, electronic, mechanical, photocopying, recording, translating or by other means without prior permission of Ford Motor Company Limited.

No liability can be accepted for any inaccuracies or omissions in this publication, although every possible care has been taken to make it as complete and accurate as possible.

WWW.RS200.ORG

Issued by: Technical Service and Publications
Parts and Service Operations
Ford Motor Company Limited
Warley
Brentwood
Essex CM13 3BW

Copyright in Great Britain, August 1986

Printed in England by Ford Motor Company Limited, Brentwood, Essex.

THE FORD SERVICE PLAN

To obtain the best possible life and reliability from your vehicle we recommend that it is regularly serviced by an Authorised FORD Dealer and to this end we have devised the FORD Service Plan.

Pre-delivery Inspection

Before delivery, your vehicle was thoroughly inspected and road tested in accordance with the Pre-delivery schedule laid down by Ford and detailed in this supplement.

The First Service

Advanced design and production techniques enable your vehicle to operate for 1,500 miles or up to 6 weeks (whichever occurs first) before routine attention beyond the normal forecourt items is due.

Service Intervals

The FORD Service Plan is based on the Standard Service which should be carried out at every 12,000 miles or 12 months (whichever occurs first) with interim service at every 6,000 miles or 6 months (whichever occurs first) interval. Consequently, following the First Service at 1,500 miles it is not necessary to have your Ford RS200 serviced until it has completed 6,000 miles or 6 months, from the date of delivery (whichever occurs first) when an interim service is due.

At every 24,000 miles or 2 years (whichever occurs first) operations additional to the Standard service are required.

These operations are listed in this supplement under Extended Service (See page 11).

It is essential that servicing is carried out regularly with a maximum 6 months interval between services, or at the appropriate mileage, (whichever occurs first). This is especially important where your vehicle is used predominantly under stop/start conditions on short journeys.

Extended Period Maintenance

In addition, to the items specified for routine service there are other parts of your vehicle which require attention for reasons of safety or reliability, at intervals which vary depending on usage.

Your Ford Dealer's knowledge and experience are the best guide to your vehicle's individual requirements. This is one of the reasons such expert attention is recommended throughout the vehicle's life and particularly with a used vehicle where its previous history is unknown. But the following general guidance should be noted.

Cooling System

Motorcraft Super Plus Anti-freeze in the correct proportions will protect your cooling system against frost damage for an indefinite period, but its corrosion inhibitors lose their effectiveness after prolonged use. Every two years or 36,000 miles (whichever occurs first) the system should therefore be flushed and refilled.

The inhibitor in some types of anti-freeze, although specified for use in cast iron or aluminium engines, will not give adequate corrosion protection at temperatures above 120°C. The RS200 engine operates at these high temperatures to ensure good performance and economy characteristics and, if not properly protected, may suffer from severe corrosion. To ensure optimum protection always insist on Motorcraft Super Plus Anti-freeze.

WWW.RS200.ORG

THE FORD SERVICE PLAN (cont'd)

Braking System:

At 36,000 miles or every 3 years (whichever occurs first), whenever disc brake pads are replaced for predominantly alpine operations the brake fluid should be drained from the system and replaced with new fluid. At the same time the condition of the visible rubber components of the system should be checked. If any deterioration is evident your FORD Dealer will advise you on the desirability of overhauling the system.

Do not hesitate to consult your FORD Dealer. He will be pleased to give you expert advice on this or any other matter.

It is additionally recommended that every 36,000 miles or 3 years (whichever occurs first) the condition and security of the exhaust system and the front wheel alignment are checked.

FORD or Motorcraft Replacement Parts

During the development of FORD vehicles, extensive testing is undertaken to ensure that all components meet the required durability standards and performance levels.

In carrying out any Assurance repairs, your FORD Dealer is required to fit FORD or Motorcraft replacement parts. To obtain the maximum benefit from the Customer Assurance it is recommended that FORD or Motorcraft parts are used for servicing and other repairs.

In addition, there are a number of key components on vehicles where this is particularly important as when these parts are renewed during repairs and servicing they have to meet stringent safety standards. To ensure this, components so fitted must be either genuine FORD or Motorcraft parts or components which meet the relevant FORD engineering specifications and quality control standards.

If any doubt exists about the suitability of parts consult your FORD Dealer.

In the event that a non FORD part is fitted to effect a 'get you home' repair, consult your FORD Dealer as soon as possible after your return.

THE VEHICLE SERVICE RECORD

Each time a FORD Dealer services your car, he will stamp the Vehicle Service Record in this supplement, and enter the date and mileage in the panel provided for the specific service ordered.

So that he can provide this valuable record of servicing, please be sure to present this booklet to him every time your vehicle goes in for a service.

WWW.RS200.ORG

PRE-DELIVERY INSPECTION

Before delivery, your vehicle was thoroughly inspected and road tested in accordance with the pre-delivery schedule laid down by FORD, as detailed below.

Inside the Vehicle

- Instruments, controls, lights, horn and optional equipment – check operation
- Wipers and washers – check/adjust

Outside the Vehicle

- Tyre pressures – check/adjust, including spare
- Wheels nuts/bolts – check/correct tightness
- Doors, bonnet, tailgate – check alignment/adjust strikers or hinges
- Bonnet lock/safety catch – check operation
- Headlamp alignment – check/adjust

Under Tailgate and Bonnet

- Engine oil level – check/top up
- Brake/clutch fluid level – check/top up
- Windscreen/headlamp washer fluid level – check/top up
- Power steering fluid level – check/top up (if fitted)
- Engine coolant level – check/top up
- Battery – check charge
- Engine compartment – check for evidence of fluid leaks
– check hoses for deterioration
- Exhaust manifold/down pipe bolts – check/correct tightness

On Hoist or Under the Vehicle

- Tyres – check for damage/specification
- Brake hoses/pipes – check for leaks/damage/chafing
- Steering/suspension – check linkage, ball joints and gaiters/boots
for damage/security
- Brakes discs, front and rear – remove protective shields
- Suspension, front and rear – remove spring chocks
- Underbody – check for evidence of leaks from engine, transmission,
steering, suspension, fuel lines/tank, exhaust system and rear axle

Road or Roller Test

- Engine – check cold and hot starting, drive performance
- Controls – check operation of handbrake, footbrake, clutch, gear change,
transmission shift, accelerator, steering, speedometer, heater and
heater controls and optional equipment.
- Check vehicle for unacceptable noises

After Road or Roller Test

- Bodywork – dewax, wash and clean, fit Next Service decal to designated
location
- Interior – check for water leaks/clean
- Exterior/interior – check for damage/soilage, condition of
metal/trim/upholstery
- Owner literature – complete owner service record and install in vehicle
- Keys – check availability and function/record key number in customer file
- Clock – set time/date

FIRST SERVICE

The first service should be carried out at 1,500 miles or 6 weeks whichever occurs first.

Inside the Vehicle

- Interior and exterior lights and optional equipment – Check operation

Outside the Vehicle

- Tyres – Check/adjust pressures including spare; check condition
- Wheel nuts – Check tightness with wheels on ground
- Headlamps – alignment, adjust if necessary

Under Tailgate and Bonnet

- Fluid Levels
 - Change engine oil and filter
 - Check/top up - Coolant
 - Check Anti-freeze strength if coolant loss or leaks are evident
 - Check - Brake and clutch fluid
 - Power steering fluid (if fitted)
- Fuel System
 - Check/adjust - Slow idle
 - Visually check fuel rail for leaks
- Turbocharger
 - Check turbo flange bolts
 - Check for evidence of fluid leaks
- Hoses and Pipes
 - Check hoses for deterioration including radiator, heater, fuel, brake, hydraulic and vacuum hoses
 - Clean oil filler cap
- Auxiliary Drive Belts
 - Check condition, adjust tension if necessary
- Cylinder Head
 - Torque bolts to specification
- Valves
 - Check/adjust clearances
- Inlet Manifold
 - Torque bolts to specification
- Exhaust Manifold and Down Pipe
 - Check tightness of bolts and nuts

Under the Vehicle

- Tyres
 - Check for wear
- Brakes/Hoses and Pipes
 - Check brake/clutch pipes, unions and hoses for leaks, chafing and rubber deterioration check fuel pressure regulation valve for leaks
- Transmission
 - Change transmission and rear axle oil, clean filter mesh and magnets
- Underbody
 - Check for evidence of fluid/exhaust leaks and general condition

FIRST SERVICE (cont'd)

The first service should be carried out at 1,500 miles or 6 weeks whichever occurs first.

Under the Vehicle

- Handbrake – Check for cable stretching (adjust if necessary)

Road Test

Includes functional checks of:

- Hand and foot brakes
- Clutch and gearchange
- Accelerator
- Steering
- Cold and Hot start
- Drive performance
- Speedometer
- Heater controls
- Unacceptable noises

After Road Test

- Engine – Check hot starting
- Halfshaft retaining bolts front and rear } – Torque to specification
- Hub bolts front and rear }
- Rear axle mounting bolts }

WWW.RS200.ORG

INTERIM SERVICE

The Interim Service should be carried out at 6,000 miles or 6 months from registration and thereafter at intervals of 12,000 miles or 12 months.

Inside the Vehicle

- Brake Fluid Level warning Light – Check test circuit
- Seat Belts – Check webbing for damage and cuts

Outside the Vehicle

- Tyres – Check/adjust pressures, including spare; check condition
- Exterior Lights – Check operation (excluding beam setting)
- Wheel Nuts/Bolts – Check tightness with wheels on the ground

Under Tailgate and Bonnet

- Fluid Levels
 - Change engine oil and filter
 - Check top/up - Brake/clutch fluid
 - Washer reservoirs
 - Coolant (check anti-freeze content, if coolant loss or leaks are apparent)
- Fuel System – Check/adjust slow idle to 1100 rpm
- Ignition System
 - Change spark plugs, adjust gaps
 - Clean distributor cap, HT leads and ignition coil tower
 - Visually check HT leads, distributor cap and rotor arm for condition
 - Check HT lead connectors for secure fit
- Engine Compartment – Check for evidence of fluid leaks
- Cylinder Head
 - Torque bolts to specification
 - Check hoses for deterioration including radiator, heater, fuel, brake, hydraulic and vacuum hoses
- Valves – Check/adjust clearances (first 6,000 miles/10,000 km only)
- Auxiliary Drive Belts – Check condition adjust if necessary

Under the Vehicle

- Engine – Clean oil filler cap
- Brake System – Check brake pads for wear - adjust handbrake pads if necessary
- Tyres – Check for wear and condition
- Underbody
 - Check for damage, including brake pipes, hoses, steering components and gaiters
 - Check for fluid leaks

INTERIM SERVICE (cont'd)

The Interim Service should be carried out at 6,000 miles or 6 months from registration and thereafter at intervals of 12,000 miles or 12 months.

Under the Vehicle

- Clutch
 - Remove clutch inspection cover, blow out dust from clutch, lubricate release bearing track on trumpet with C.S. grease
- Transmission
 - Change transmission and rear axle oil, clean filter meshes and magnets
 - remove oil feed jet from transfer box, clean/blow out and replace

Road Test

Includes functional checks of:

- Hand and foot brake
- Clutch and Gearchange
- Accelerator
- Steering
- Cold and Hot start
- Drive performance
- Speedometer
- Heater Controls
- Unacceptable Noises

After Road Test

- Engine
 - Check hot starting
- Halfshaft bolts
 - Torque to specification
- Hub bolts
 - Torque to specification
- Rear axle mounting bolts
 - Torque to specification

WWW.RS200.ORG

STANDARD SERVICE

The Standard Service should be carried out at 12,000 miles from registration and thereafter at intervals of 12,000 miles or 12 months.

Inside the Vehicle

- Interior and exterior lights and optional equipment – Check operation
- Brake fluid level warning light – Check test circuit
- Seat belts – Check webbing for damage and cuts

Outside the Vehicle

- Tyres – Check/adjust pressures, including spare; check condition
- Doors – Check operation, check strap, latches and locks (lubricate if necessary)
- Bonnet lock and tailgate lock – Check operation, lubricate if necessary
- Door hinges – Lubricate
- Wheel nuts/bolts – Check tightness with wheels on the ground

Under Tailgate and Bonnet

- Fluid levels
 - Change engine oil and filter
 - Check/top up - washer fluid reservoir
 - coolant (check anti-freeze content if coolant loss or leaks are apparent)
 - brake/clutch fluid
- Battery terminals – Check tightness, clean and grease if necessary
- Auxiliary drive belts – Check condition, adjust tension if necessary
- Head bolts – Check torque, adjust if necessary
- Valves – Check/adjust clearance
- Inlet manifold bolts – Torque to specification
- Exhaust manifold downpipe nuts and bolts – Check/correct tightness
- Ignition system
 - Renew spark plugs
 - Clean distributor cap, HT leads and ignition coil tower
 - Visually check HT leads, distributor cap and rotor arm for condition
 - Check HT leads connectors for secure fit
- Fuel system
 - Check/adjust slow idle to 1100 rpm
 - Visually check fuel rail for leaks
- Engine Compartment
 - Check for evidence of fluid leaks
 - Check hoses for deterioration including radiator, heater, fuel, brake, hydraulic and vacuum hoses
 - Renew fuel filter

STANDARD SERVICE (cont'd)

Under Tailgate and Bonnet

- Exhaust system – Check connections and brackets
- Turbocharger
 - Check turbo flange bolts
 - Check security of turbo support brackets
 - Check/correct tightness of manifold nuts

Under the Vehicle

- Hand brake – Lubricate linkage, check operation, adjust pad to disc clearance if necessary
- Wheel bearings – Check front and rear wheel bearings and if any play is detected refer to Workshop Manual
- Brake system – Check pad wear
- Clutch – Remove inspection cover, blow out dust from clutch, lubricate bearing track on trumpet with C.S. grease
- Steering – Check steering and suspension linkage and rose joints for damage and wear, gaiters and ball joint covers for security condition and leaks
- Transmission – Change transaxle and rear axle oil, clean filter mesh and magnets, remove oil feed jet from transfer box, clean, blow out and replace
- Underbody
 - Check drive shaft gaiters for security, condition and leaks
 - Check the general condition of the underbody, front and rear suspension sub-frames
 - Check for fluid and exhaust leaks
 - Check brake/clutch pipes, unions and hoses for leaks chafing and rubber deterioration

Road Test

Includes functional checks of:

- Hand and foot brake
- Clutch and Gearchange
- Accelerator
- Steering
- Cold and Hot start
- Drive performance
- Speedometer
- Heater Controls
- Unacceptable Noises

After Road Test

- Engine – Check hot starting
 - Halfshaft bolts check
 - Front and rear hub bolts check
 - Rear axle mounting bolts check
- } – Torque to specification

EXTENDED SERVICE

In conjunction with the Major Service, the following additional items should be carried out at 24,000 miles or 24 months from registration and thereafter at intervals of 24,000 miles or 24 months.

Under The Tailgate

- Cylinder head – Check torque and adjust to specification
- Valves – Check/adjust clearances
- Engine – Change air filter element
– Change crankcase emission valve

Under the Vehicle

- Fuel filter – Renew

From time to time technological developments call for changes in the published operations or their intervals. Details of such changes may be seen at your FORD Dealer's premises.

EXTENDED PERIOD MAINTENANCE

It should not be forgotten that there are other checks apart from those covered in the routine service; they are covered in the Section called 'FORD SERVICE PLAN' (See pages 2 & 3).

WWW.RS200.ORG

REGULAR MAINTENANCE, AND CARE 06

WWW.RS200.ORG

Index

	Page
Recommended Driver Maintenance	2-8
Tyres and Chains	9
Seat Belts	10-11
Car Care	12-13
Cleaning	14
Lubricants and Fluids	15-16

Regular maintenance

Regular maintenance on your RS200 falls into two categories:

Ensuring that the car is serviced by your FORD RS Dealer at the recommended intervals.

Taking the time, yourself, to carry out certain visual checks and, where necessary, to make minor adjustments.

These checks are all recommended, so that you can maintain your FORD RS200 in good condition and, when carried out regularly, will prolong its operating life.

Service intervals on all FORD models have gradually been extended over the years, as a result of engineering advances made on various components. This has reduced the time that a car needs to be off the road for this important work ... an advantage from your point of view.

However, it also reduces the frequency with which your car comes under the expert eye of FORD RS Dealer technicians. Consequently, during the period between recommended services, there are several items that require regular checking.

Listed below are suggested checks which you should try to carry out, at the intervals shown. A quick visual check is always possible, where items have transparent containers - such as the windscreen washer reservoir, the brake and clutch fluid reservoirs, and the engine coolant header tank.

RECOMMENDED DRIVER MAINTENANCE

Checks to be made when refuelling the RS200

- Engine oil level. Always do this with the engine running, so that the dipstick reading in the dry sump oil tank will be correct. See page 03-4.
- Brake fluid reservoir level (two reservoirs). See page 03-6.
- Clutch fluid reservoir level. See page 03-6.
- Engine cooling water, header tank level. See page 03-3.
- Windscreen washer fluid level. See page 03-5.
- Tyre pressures, visual check. See page 03-9.

Checks to be made daily

- Correct functioning of all exterior lights, which includes brake lights, turn indicators (and side repeaters), and hazard flashers. Replace any burnt-out bulbs and fuses as soon as they are discovered, and ensure that all lenses are kept clean.

Checks to be made monthly (or more frequently, if the RS200 is habitually used over rough ground)

- Engine coolant level. See page 03-3.
- Careful visual check for leaks around assemblies, pipes, hoses and reservoirs - not forgetting the rear final drive, the battery, and the area under the twin fuel tanks.
- Integrity of oil lines from engine to external heat exchanger, and from the transmission casing to the front oil cooler.
- Integrity of all brake lines and joints.
- Condition of air cleaner element, and all turbocharger/intercooler trunking.
- Handbrake operation, and adjustment.
- Careful 'spanner check' of all suspension, steering, and structural connections. If necessary, restore nuts and screws to their recommended torque ratings.

Oils, fluids and greases

Because the RS200 is a very high performance car, designed to be especially suitable for use in competition work, the engine is much more powerful than that found in other FORD products, and the technically advanced four-wheel-drive transmission has a very demanding job to do.

At the end of this section, a complete list of the lubricants used, and recommended, for every aspect of the RS200's operation is given. The same lubricants, or their equivalents, should always be used when refilling, changing, or re-assembling the appropriate section of the car.

A range of FORD or Motorcraft lubricants is available in the usual viscosity and work-load ranges, and these are suitable for most temperature and usage requirements.

Do remember, use only FORD and Motorcraft parts and approved or specified lubricants. These, when changed at the correct intervals, will assist in prolonging the life of working components. The use of wrong or unsuitable materials could result in expensive repairs or even invalidate the 'Assurance' or 'Warranty'. In the section 'Technical Data' a chart is given showing a number of different engine oil viscosity grades for use in exceptional cases where FORD or Motorcraft Super Motor Oils is not available. At filling stations always insist that only oils are used which are specified for FORD vehicles by the Ford Motor Company.

⚠ WARNING—Keep oils, fluids or greases safely locked away from children. Always take note of the safety precautions on the containers.

Engine oil level

As already explained in the section on FILLING STATION INFORMATION (see page 000), the RS200 is fitted with a 'dry sump' engine lubrication system, which means that the level of oil in the separate tank should always be measured with the engine and oil warmed up, and with the engine having been running at idling speed for 20 to 30 seconds, but stopped when making the check.

To check the level, make sure the car is standing on level ground. Pull out the dipstick which is in the top of the tank, not in the side of the engine block, wipe it with a clean, non-fluffy, cloth, re-insert it, then pull it out again. The film of oil clinging to the dipstick will indicate the oil level.

Keep the level topped up, so that the stick reading is always at or near the 'MAX' mark, but never overfill. The difference between MAX and MIN markings is 2-litres/4 pints.

Under normal operating conditions, the engine oil and the filter should be changed at the intervals specified in the SERVICE PLAN.

However, if the RS200 is habitually used in more severe conditions, such as for short-distance stop-start motoring, frequent cold starting, or dusty road and track conditions, the oil and filter changes should be made at more frequent intervals.

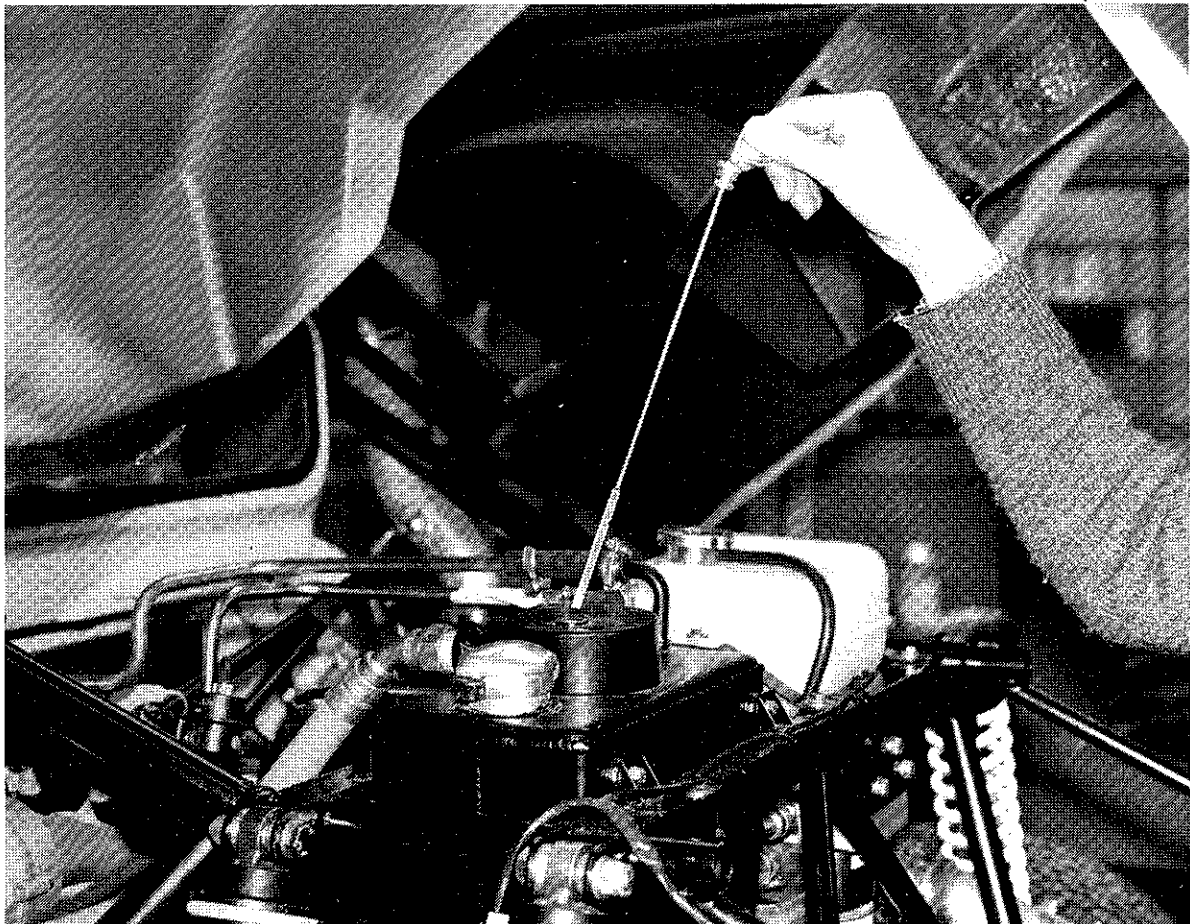

Transmission, and rear final drive, oil levels

The RS200 is fitted with easy-to-reach dipsticks for the main transmission casing, and for the separate rear final drive casing, so that the lubricant levels may be checked.

To check the levels, make sure that the car is standing on level ground. The ideal time to do this is two or three minutes after the car has been brought to a halt after a normal run. The transaxle oil level must be checked with the engine idling. This is not necessary when checking the rear differential oil level.

The dipstick to the main transmission casing is at the forward end of the casing, and is accessible by raising the front body section and removing a panel from the floor of the luggage container. The dipstick in the rear final drive casing is accessible by raising the rear body section.

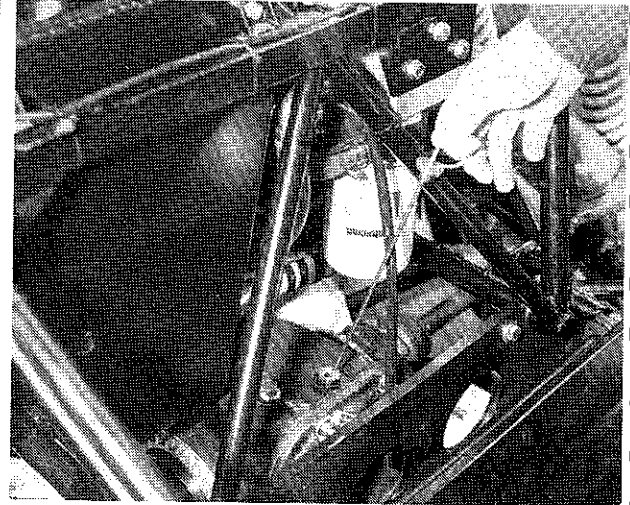
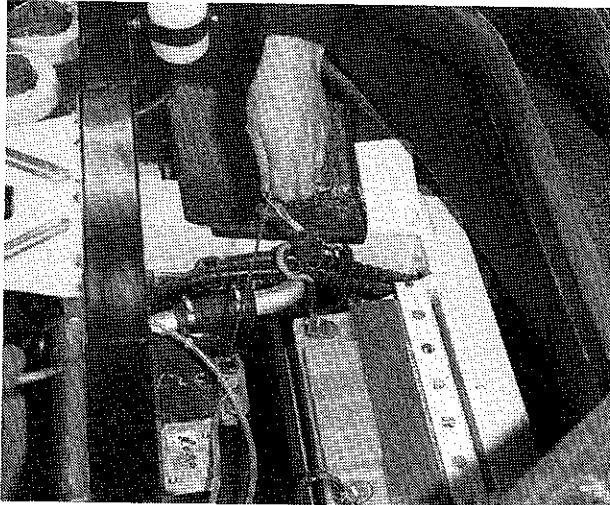

In each case, pull out the dipstick, wipe it with a clean, non-fluffy cloth, re-insert it, then pull it out again. The film of oil clinging to the dipstick will indicate the oil level.

Keep the levels topped up, so that the stick readings are always at or near the 'MAX' mark, but never overfill.

To top up the main transmission, remove the plug fitted to the boss at the front of the assembly, very close to the dipstick, on the right side of the centre line, making sure that the plug is securely re-fixed afterwards.

To top up the rear final drive, add oil through the dipstick hole.

Under normal operating conditions, the transmission oils should be changed at the intervals specified in the SERVICE PLAN.

However, if the RS200 is habitually used in more severe conditions, such as for short-distance stop-starting motoring, frequent cold starting, or dusty road and track conditions, changes should be made at more frequent intervals.

Brakes and clutch fluid levels

Under the front body section, close to the cross-member linking the front spring top mounts, are three translucent reservoirs. The two larger diameter reservoirs serve hydraulic brake circuits, the smaller reservoir the clutch circuit.

For each Brake Fluid Reservoir:

Check that the brake fluid is up to the 'MAX' line marked on the side of the reservoir. The brake fluid level warning light will illuminate if the fluid level drops below the 'MIN' mark.

If it is necessary to top up the reservoir, use only FORD brake fluid or a fluid meeting FORD specification SAM-6C9103-A. AP DOT 4 fluid is recommended.

The efficiency of the brakes may be impaired if the fluid used does not meet this FORD specification or if the fluid used has been exposed to air for any length of time. This is because it can absorb moisture from the air which can impair its performance under conditions of heavy usage.



WARNING—

- Never let the level of brake fluid fall below the 'MIN' line.
- If brake fluid is spilt on paintwork, the affected area must be washed down with a wet sponge immediately.

It is a good practice to check the operation of the brake fluid level warning light each time you check the fluid level. Press the button on top of the reservoir cap (beneath the rubber membrane), and ask someone to see if the brake fluid level warning light on the fascia illuminates. If the light fails to illuminate have the system checked by your FORD Dealer.

Check the Clutch Fluid Reservoir at the same time, and for the same purpose. However, there is no fluid level warning light in this circuit.

Cooling system

The cooling system should be drained down, flushed, and refilled with a new coolant mixture, as specified, every 60,000 km (36,000 miles), or at least every two years, whichever ever occurs first. This is because even the best corrosion inhibitors, which are so necessary in the RS200 because of its aluminium alloy engine cylinder block and head, lose their effectiveness after this period.

For all motoring climates and conditions, the system should always be refilled with a 50 per cent water and 50 per cent Motorcraft 'Super Plus' antifreeze (which is pink in colour).

Antifreeze

 **WARNING—**The inhibitor in some types of antifreeze, although specified for use in cast iron or aluminium engines, will not give adequate corrosion protection at temperatures above 120°C.

Present day engines operate at these high temperatures to ensure good performance and economy characteristics and, if not properly protected, may suffer from severe corrosion. To ensure optimum protection always insist on antifreeze material manufactured to FORD specification SSM-97B9103-A.

For the filling capacity of the cooling system, refer to the TECHNICAL DATA section.

Battery

The RS200 is fitted with a Motorcraft 'Maintenance Free' Battery. Checking and topping-up the electrolyte level is no longer required throughout the normal life of the battery.



WARNING—

- The battery leads should be disconnected only with the engine switched off. When disconnecting the battery, always remove the negative (ie earth) lead first.
- Do not let the spanner touch both terminals of the battery or the positive terminal and any part of the vehicle body. This will short-circuit the battery.
- When reconnecting the battery, ensure that the negative terminal is connected last.
- The main wiring loom is connected to the positive terminal of the battery by a 'fuse link'. If the vehicle battery or any auxiliary battery is connected incorrectly, or if there is a short circuit in the loom, this link will 'blow' and all of the electrical system will cease to operate. The link should be replaced by your FORD Dealer if this should occur.

Battery charging



WARNING—The process of charging a battery causes highly inflammable hydrogen gas to be formed. Consequently, when charging a battery, the following precautions must be observed:—

- Charging must be carried out in a well ventilated area. When charging in situ, the bonnet should be left open.
- The battery charger must be switched off before disconnecting the charging leads from the battery.
- Never smoke or ignite a naked flame near a battery which is being charged, or has just been charged.
- **When charging in situ, both the battery cables MUST be disconnected from the battery, or the engine management system module WILL BE DESTROYED.**
- When bench charging, do not refit the battery in the vehicle for five to ten minutes after the charging equipment has been disconnected as the battery continues to give off hydrogen gas for a short period after the charging has been completed.

'Maintenance Free' battery charging

Should a 'Maintenance Free' battery become partially discharged and fail to start the vehicle, it can be recharged using normal 12 volt charging equipment. However it is recommended that the charger is switched off if the electrolyte starts to effervesce.



WARNING—Never use a battery charger with a nominal voltage greater than 12 volts. If a normal 12 volt charger fails to recharge a 'Maintenance Free' battery, have the battery checked by your FORD Dealer.

Ignition system

For the engine to produce its optimum power, torque, and fuel efficiency, the ignition system needs to be in perfect condition.

⚠ WARNING—When carrying out any work in the area of the ignition system, take care to avoid possible electric shocks caused by high-voltage cables.

Checking spark plugs and leads

Before checking detach the earth lead (negative terminal) from the battery. Clean the spark plug insulators, ignition leads and the ignition coil using a clean rag, and check these items for breaks, cracking and other damage. When handling the spark plugs, be especially careful not to damage the brittle ceramic insulator. You can check the electrode gap (a) with a suitable feeler gauge and correct it by bending the earth electrode (see 'Technical Data' for spark plug type and electrode gap). If the spark plugs are excessively worn, or fouled with carbon deposits around the end of the electrode, they should be replaced. This should also be done for other damaged or worn parts.

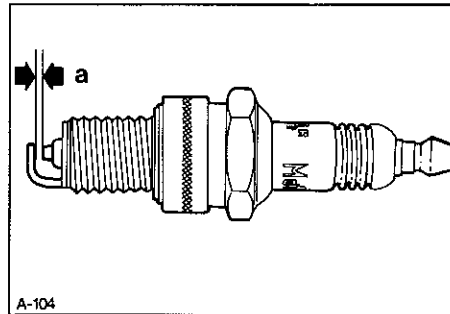

N.B. Only the special spark plug spanner supplied in the tool kit should be used for plug removal and replacement.

Checking for leakage and corrosion

A driver's routine with his car should include occasional visual checks for leaks and corrosion, around all major components, pipes, hoses, reservoirs, the exhaust system, etc.

Before checking anything, always ensure that the car's handbrake is applied, and that the gear lever is in neutral.

In the engine bay

Start the engine, then check all round it, by viewing from above, and from each side.

⚠ WARNING—When checking items in the engine bay with the engine running, make sure that no items of clothing can become entangled with the alternator drive belt.

Check for signs of leakage in the following areas: Camshaft chest cover gasket, cylinder head gasket, crankshaft pulley, oil pressure switch, oil filter, water/oil heat exchanger, fuel injection system, fuel pumps, fuel lines, cooling system hoses and tank, thermostat housing and gasket, water pump, exhaust system, turbocharger installation (**Danger: This becomes extremely hot**), intercooler and trunking, and brake lines.

Under the vehicle

Run the vehicle on to the ramps, over an inspection pit, or jack up the vehicle securely on stands. NEVER rely on the vehicle's own jack, unassisted, to support the car while you carry out this inspection.

Check for signs of leakage from the oil sump and the oil lines, the clutch hydraulic circuit, the brake lines and hoses, the brake assemblies at the wheels, the engine coolant lines to the front radiator, the area under the fuel tanks (behind each passenger seat), the transaxle housing, and the transaxle oil lines to the oil cooler at the front of the car.

If any leak is found, or if you are uncertain about the suitability of any particular system, consult your FORD Dealer for further advice.

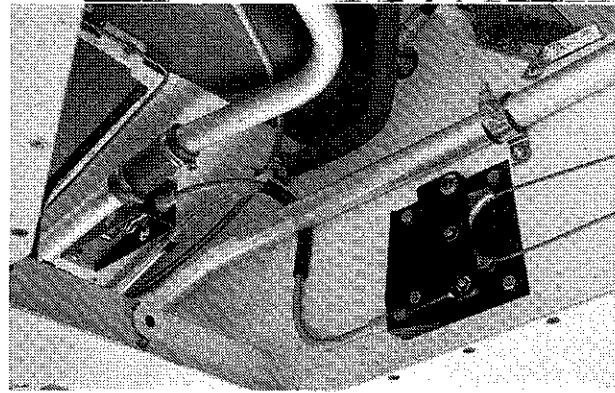

Exhaust system

Because of the use of a turbocharger installation, the exhaust system is more complex than on a conventional car. With the engine running, check out all the joints for leaks. Because of the layout of the RS200, this can all be done without crawling under the car. It may be advisable to remove the spare wheel and tyres from its fixing in the tail to inspect the condition of the main silencer.

⚠ WARNING—This should be done immediately after a cold start, when the engine is running smoothly but before the pipes become too hot.

When checking the braided section, avoid any braid splinters, which could hurt your hands.

TYRES AND CHAINS

New tyres

When running-in your new RS200, or after fitting replacement tyres, run the tyres carefully for the first 150 km (100 miles), by not driving at high speeds, and by avoiding sharp cornering.

Tyre pressures

Check, and if necessary, adjust the tyre pressures only when they are cold, using an accurate tyre pressure gauge. Do not forget the spare tyre, which is housed in the tail, and accessible by raising the rear body section.

Recommended pressures for the RS200, in all operating conditions, are 2.0 Bar/29 psi.



WARNING—Driving a vehicle on tyres inflated below the specified pressures affects the safety of the tyre, leads to premature wear and high fuel consumption. Unbalanced wheels cause uneven wear. If a tyre is damaged, see a tyre specialist. Never attempt a makeshift repair yourself. It is important that replacement tyres should be of the same size, type and speed rating as those originally fitted to your vehicle as any variation could adversely affect safety and handling.

Tyre tread

Check tubeless radial tyres at least once a month or before commencing long trips. Is the tyre pressure correct? Are there are signs of cuts, damage to the side-walls and tread, foreign matter, or excessive wear? Uneven tyre wear may indicate incorrect wheel alignment.

Tyre depth

Measure the depth of the tread in several places across the width of the tyre. Pay attention to legal requirements regarding tyre depth.

Winter tyres

When operating the vehicle with winter tyres, which must be fitted to all four wheels, do not exceed the permitted maximum speed for the tyres as given by the tyre manufacturer.

Snow chains

Snow chains can be fitted to the tyres. It is advisable to use chains with small links to ensure sufficient clearance between chains and wheel arches. The chains must be removed when driving for long distances on snow-free roads.

SEAT BELTS

SEAT BELTS

Your RS200 is equipped with inertia reel seat belts.

⚠ WARNING—You should always wear your seat belt when travelling in the car - no matter how short the journey may be.

Seat belts must never be used to retain more than one person - particularly a child on another person's lap. Never allow children to stand or kneel on any seat.

The belts installed in this car are intended for use by occupants of adult build.

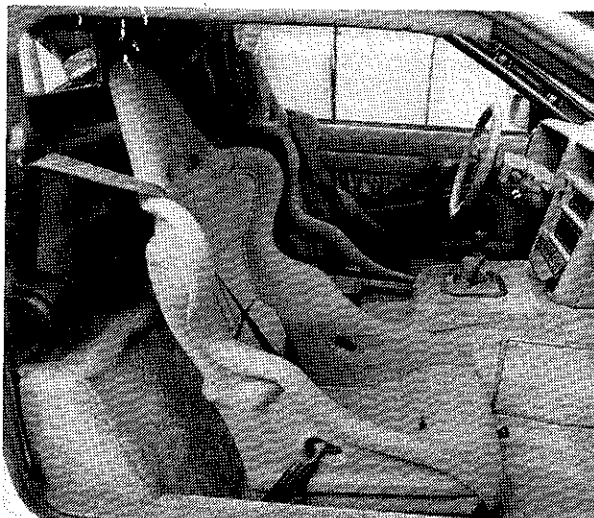
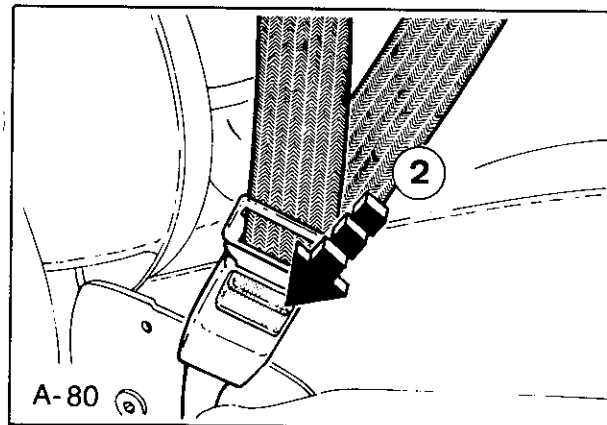
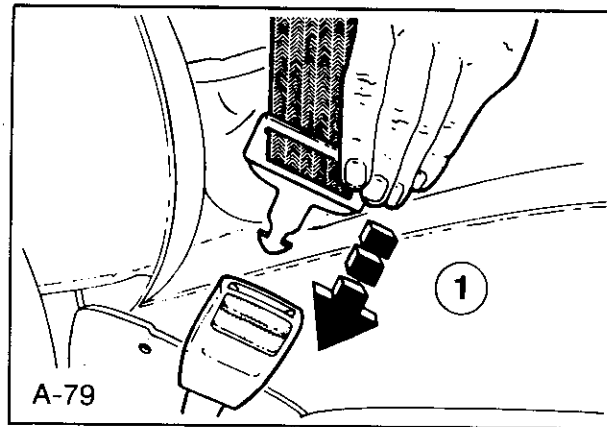

WWW.RS200.ORG

Inertia reel seat belts

An inertia reel belt should be pulled slowly and steadily out of the reel and, ideally, the car should be on level ground, otherwise the reel may lock. If this does occur, allow the belt to retract a little and then continue pulling the belt out of the reel. Since the mechanism is sensitive to vehicle attitude, this may not be possible until the car is on level ground. Function of the reel mechanism can be checked by giving the diagonal portion a sharp tug; the inertia reel should then lock.

To wear an inertia reel seat belt, put your arm through the long loop of the webbing and push the metal tongue into the belt buckle (1) until a click is heard. Make sure that the lap portion of the belt fits snugly across the hips in a low position. To do this, ensure that there is no loose webbing on the lap portion of the belt by pulling the diagonal strap through the tongue and check that the webbing is not twisted between the fixing points. To release the belt, press the red button on the buckle (2). Although the belt will then roll-up automatically, it is advisable to guide the tongue to prevent it retracting too quickly and possibly striking the window glass.

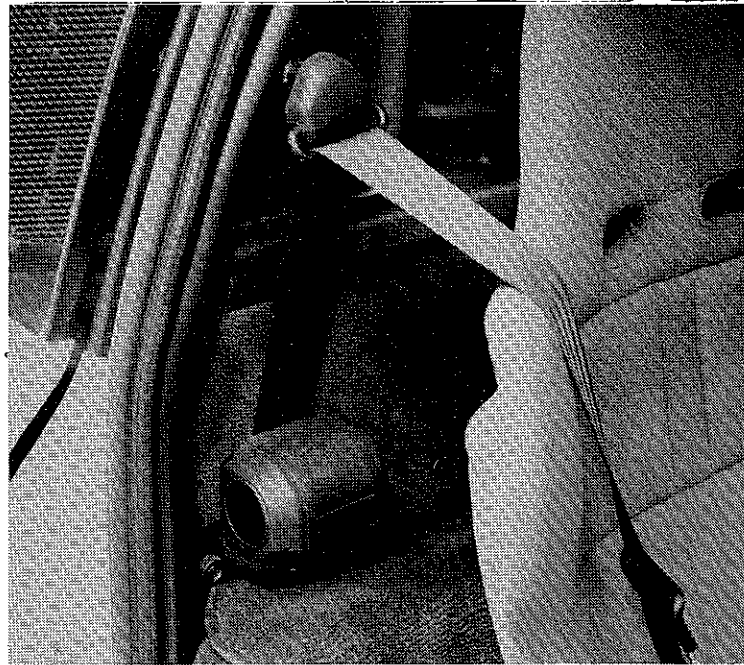

Function and condition of seat belts

For your own safety, you should periodically check your seat belt. Examine the belt webbing, look for signs of wear, tears, damage or general deterioration. Give the belt a sharp tug to ensure that the mountings are firm. Check that the buckles latch properly and that the inertia mechanism functions correctly. Never lubricate the mechanism. The belts should be renewed if subjected to the strain of severe impact and also if they show sign of excessive fraying or of having been cut. If any doubt exists regarding the suitability of the belts for future service, consult your FORD Dealer.

The effectiveness of seat belts will be impaired if any changes or alterations are made to them. If, for any reason, they are removed from the vehicle, re-assembly should be carried out to the exact instructions given in the vehicle's 'Workshop Manual'. This should therefore be carried out by your FORD Dealer.

Seat belts

The webbing should be lightly brushed with Motorcraft Upholstery Cleaner only. Rinse and dry naturally, away from artificial heat. Do not use dry clean fluid or boiling water, bleach or dye the belts. Do not allow moisture to penetrate the inertia reel retractor mechanism.

CAR CARE: LOCKS, HINGES AND CATCHES

Operate all the doors, the front and the rear body sections to ensure smooth movement. If necessary, lubricate the hinges. Apply a light smear of grease to the working surfaces of the tailgate catches. To lubricate a door hinge, apply a few drops of oil through the hole on the hinge (see arrow in illustration).

Open and close the doors to check the latching operation. Check that the door latches on both the safety and fully latched positions, without excessive effort, and that the door is not raised or lowered by the latching operation.

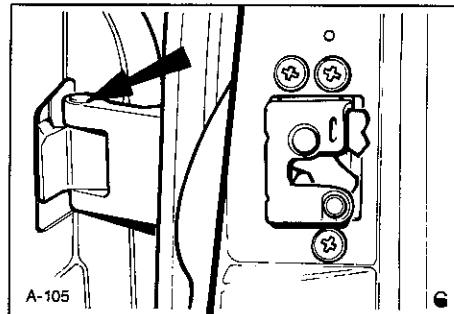

Winter operation of door locks

Periodic lubrication of lock cylinders is recommended especially before the winter period. Before lubricating, slide the protection shutter to one side so that the lubricant can penetrate into the cylinder. This can be effected by lubricating the key and inserting it into the lock several times and turning. **Do not** use conventional de-icer on locks, otherwise corrosion of internal lock mechanism may result. Use only FORD/Motorcraft lock de-icer.

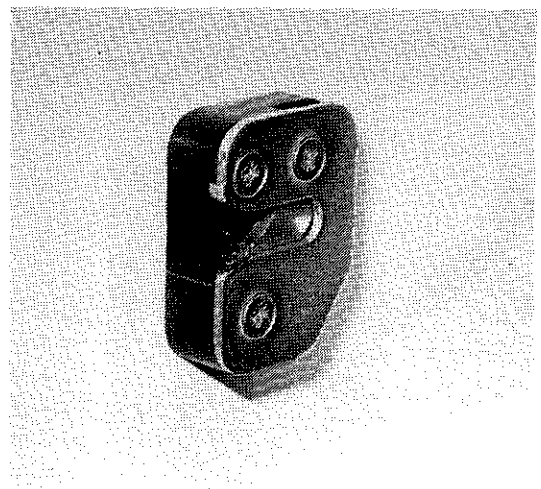
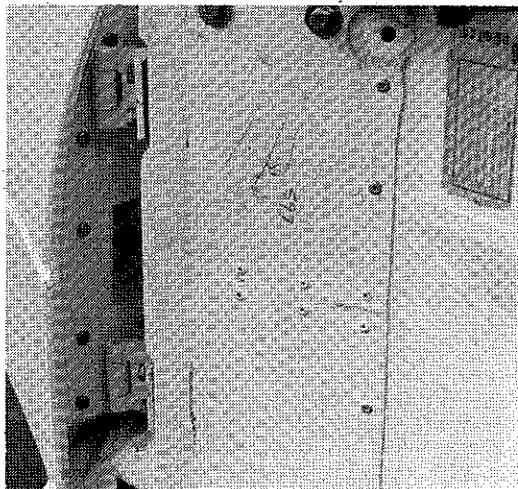

Corrosion protection

The effectiveness of the Corrosion Protection treatment applied to your car in production varies with the climatic and road conditions under which you use your vehicle. In a warm, dry climate, that protective treatment will remain effective for a much longer period of time, or mileage, than on a vehicle operated in conditions of high humidity, on loose road surfaces or roads treated with salt and grit or other chemical agents. If you operate your car under these adverse conditions, FORD recommends that you have your car checked periodically at your FORD Dealer and renew the treatment if necessary.

Additional underbody protection will be beneficial, particularly when your vehicle is operated in cold climates where salt is used to clear ice and snow. Your FORD Dealer will be able to advise you which suitable underbody protection processes are available locally.

Car cleaning

Wash frequently with cold or lukewarm water. Never use household soap or detergent, though you will find MOTORCRAFT Car Shampoo (MOTORCRAFT Part No. EXC-1) will be helpful in removing traffic film. Wash off the dirt with a sponge, using plenty of water, rinse and then dry off with clean chamois leather. It is recommended that you have the underbody of the car washed once a year at the end of winter. When using a hose, avoid directing it at full force against paintwork.

Automatic car wash

It is recommended that you wash your new FORD manually during the first two months so that the fresh body paintwork is preserved. If any aerials are first retracted, the RS200 may then be put through any conventional automatic car wash, as required.

Glass and wiper blades

When washing the windscreen hinge the wiper blades away from the screen. Washing and polishing agents containing silicone should not be applied to the glass. They will cause smears which reduce visibility, particularly during darkness and in rain. The rubber blades can be damaged by contact with materials such as car cleaning agents, grease, silicones or fuel. It is therefore recommended that the wiper blades and windscreen are regularly cleaned using only MOTORCRAFT Cleaning Paste (FORD Part No. 81AG-19523-AA). The Cleaning Paste should be applied vigorously, using a damp sponge, and then rinsed off with clean water, or wiped off with a clean cloth. Damage to the blades can also occur from automatic car wash equipment. This will be minimised if the wipers are parked in the vertical position.

Paint chip repair

The paint work should be inspected periodically for chips or scratches. This is best done when the vehicle is being cleaned. Pay particular attention to the front and sides of the vehicle which may have been chipped by stones thrown up by your own car, or other vehicles. The edges of the doors may have been chipped or scratched if opened against a wall or other obstruction.

Small paintwork blemishes should be dealt with immediately in accordance with FORD specifications to prevent deterioration.

RS200 paint finish

All RS200s were originally painted in FORD Diamond White colour, for which the paint specification is: XSC 691.

CLEANING

Exterior rear view mirrors

To prevent scratches care should be taken when cleaning exterior rear view mirrors, particularly where 'first surface' mirrors are fitted, as these have an external reflective surface.

- Always soften dirt and mud with soapy water before washing mirror surfaces.
- Wash off all dirt and mud before polishing mirror with a soft cloth.
- Never use abrasive cleaning compounds.
- Remove frost and ice with a plastic scraper; never use a metal scraper.

Tar spots

Motorcraft Tar Remover should be used to remove tar spots from the bodywork.

Car polishing

Motorcraft Car Wax protects your FORD from aggressive atmospheric particles and also prevents harmful deposits penetrating into the paintwork. For additional protection, the paintwork can be treated with Motorcraft Liquid Car Polish.

Upholstery and trim

The easiest way to keep the interior clean is to vacuum-clean it regularly. Stains are best removed with Motorcraft Upholstery Cleaner which is suitable for both vinyl and fabric trim. Never use a petroleum or spirit solution on any interior trim.

Seat belts

The webbing should be lightly brushed with Motorcraft Upholstery Cleaner only. Rinse and dry naturally, away from artificial heat. Do not use dry clean fluid or boiling water, bleach or dye the belts. Do not allow moisture to penetrate the inertia reel retractor mechanism.

Light alloy sports road wheels

Wash wheels frequently with cold or lukewarm water. Never use any form of abrasive as this will permanently damage the special finish.

Recommended lubricants and fluids

Throughout its development period, as a vehicle which could be prepared for competition use, the FORD RS200 used certain specific lubricants and fluids. These are listed below, and, where appropriate, alternative lubricants are also noted.

Engine

The recommended oil is Ford Oil, whose viscosity rating is SAE 10/40. This is suitable for all ambient temperatures which the RS200 will encounter.

Transmission

For the combined gearbox, centre differential, front differential and transaxle, the recommended oil is Castrol TAF-X, or alternatively Veedol TAF-20. This has a rating of SAE 75W-90.

For the rear differential, the same recommended lubricants - Castrol TAF-X, or Veedol TAF-20, should be used.

To lubricate the external gear linkages, use General Purpose Grease, meeting FORD Specification SMIC-4515-A.

Propeller shaft universal joints

Use Mobil 525, which meets Hardy Spicer specification MS091G (FORD Specification S-MIC-75A).

Front drive shaft joints

For the outer 'Rzeppa' joint, use Hardy Spicer specification MS091G grease (FORD specification S-MIC-75A), approx 75 gm total.

For the inner 'Tripode' joint, use Hardy Spicer specification MS75 grease, or Mobil 525 (FORD specification SQM-1C-900-4A), approximately 160 gm total.

Rear drive shaft joints

For both Inner and Outer joints, use a Dow Corning Molycote VN 2461C grease (MSO63G120), approximately 120 gm each joint.

Hub greases

Use FORD High Temperature Greases

Power-assisted steering fluid (if the optional power-assisted steering kit is subsequently fitted).

Use FORD Automatic Transmission Fluid, meeting FORD Specification SQM-2C9010A (FORD Part No. A80SX19547AA)

Engine Cooling Water/Inhibitor

Use a 50 per cent water/50 per cent FORD Motorcraft Super Plus Antifreeze (pink in colour), meeting FORD Specification SSM-97B9103-A (FORD Part No. A800X 19544BA/CA), at all times.



WARNING—The inhibitor in some types of anti-freeze, although specified for use in cast iron or aluminium engines, will not give adequate corrosion protection at temperatures above 120 deg. C. Present day engines operate at these high temperatures to ensure good performance and economy characteristics and, if not properly protected, may suffer from severe corrosion. To ensure optimum protection, always insist on anti-freeze material manufactured to FORD Specification SSM-97B9-103A.

For braking and clutch system

Use Automotive Products fluid, AP DOT 4.

For screen washer systems

Use water mixed with Motorcraft Windscreen Washer Fluid (FORD Specification SA72SX 19550 BA). If anti-freeze protection is necessary (the reservoir is mounted in the nose of the RS200, well away from engine heat source), add fluid meeting the same specification.

For locks, catches and hinges

Use Multi-Purpose Grease, meeting FORD Specification SM1C-4515-A.

WWW.RS200.ORG

SPECIFICATION, EQUIPMENT AND COMPONENT CHANGES 07

WWW.RS200.ORG

Index

	Page Nos.
Engine	2-20
Cooling System	21-24
Transmission	25-40
Front Suspension	41-52
Steering	53-58
Rear Suspension	59-69
Braking System	70-79
Fuel System	80-82
Body Shell and Panels	83-93
Electrical Equipment	94-110

Index

	Page
Engine unit	3-4
Cylinder head camshaft cover	5
Valve clearance adjustment	5
Engine on stand	6-7
Camshaft drive belt	8
Camshafts	9-10
Cylinder head gasket	11
Air cleaner	12
Intercooler	13
Inlet manifold, and 'O' rings	14
Exhaust manifold	14-15
Turbocharger	16
Exhaust system	17
Engine oil tank	18
Oil/water heat exchanger	19
Oil filter	20

Engine unit

The basic layout of the engine fitted to the RS200 will be familiar to previous owners of high-performance FORD machinery, for it has been developed from the twin-overhead camshaft, four-valves per cylinder BDA Unit, designed for FORD By Cosworth Engineering. For the RS200, its displacement is 1.8-litres. There is Ford-Bosch electronically controlled fuel injection, and the unit is turbo-charged.

The cylinder block, and the cylinder head, are cast alloy, the camshafts are driven by toothed belt, and there is dry sump lubrication. A Ford EEC IV Electronic Engine Management System looks after the function, control, and adjustment to suit, operating and atmospheric conditions, of the engine's fuel injection and ignition systems.

To remove the engine unit from the car's structure, for attention, or for modification, proceed as follows:

Removal

1. Remove the rear body section
2. Support the vehicle body/chassis unit on stands, at front and rear
3. Remove the rear wheels, to improve access to the engine bay
4. Remove the spare wheel, and the supporting frame
5. Remove the exhaust system
6. Remove the rear suspension spring/damper units - two each side
7. Remove the tubular rear cradle complete with oil tank, water header tank, and piping. Bung the open end of every pipe
8. Remove the inlet intercooler assembly and piping, complete
9. Remove both tubular sub-frames which link the cockpit roll cage to the tubular rear cradle and the body/chassis unit.
10. Disconnect the battery at the front of the car, then disconnect all electrical, water, oil and fuel connections to the engine, noting the position and function of each one. Mark up, and identify them, as appropriate.
11. Remove the starter motor from the engine
12. Remove the turbocharger assembly from the exhaust manifold
13. Remove the exhaust manifold from the engine
14. Remove the engine inlet manifold brace (which links manifold to engine mounting)
15. Support the engine on a crane, ready for removal, and take the strain, using slings
16. Remove both engine mountings, from the engine and the chassis
17. Disconnect all engine/clutch bellhousing and sump/bell housing connections, and support the bell housing/transfer gear assembly on a jack
18. Gradually and carefully withdraw the engine, by lifting and pulling back from the structure.

Re-assembly and re-installation is in the reverse sequence. Special care must be taken to ensure that the clutch release bearing arm is not displaced from its correct position. Care must also be taken to ensure that the flywheel sensing electrical lead is not damaged.

After re-assembly, take especial care to see that the engine oil system, and the cooling system, are correctly filled, and leak free. **Do not run the engine until the transmission assembly has also been installed, its oil pipes connected up to the Transfer Box, and the correct amount of Transmission Fluid has been added.**

Failure to take this precaution will quickly lead to the failure of the oil seals in the Transfer Box, and to the Transfer gears themselves.

When re-assembling, use new gaskets and seals wherever existing components have been disturbed.

Upgrading the engine for serious motor sport

See *Optional Ford Motorsport Parts* section

Rear of car with body cover removed

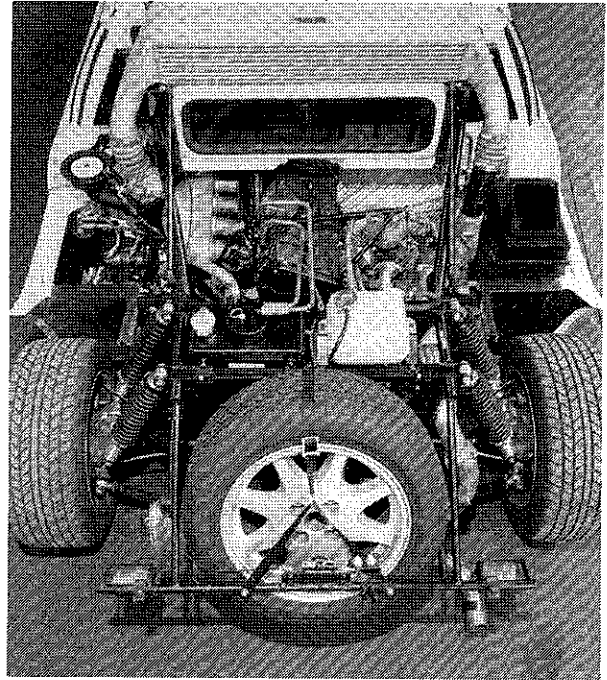
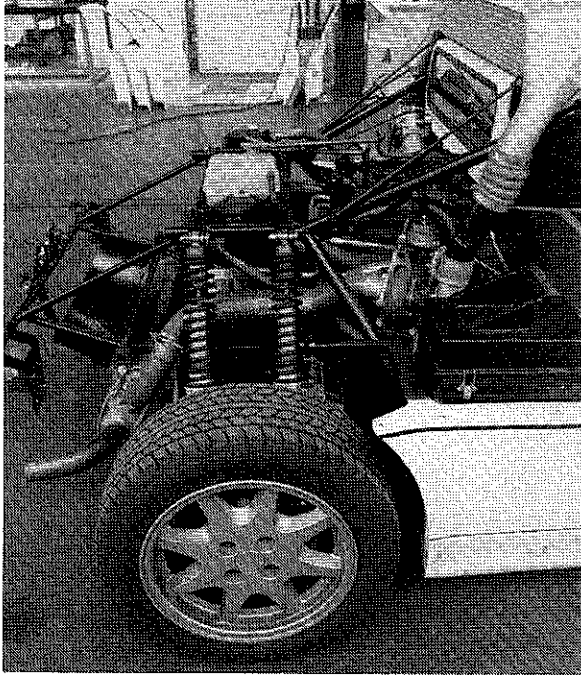

Rear sub-frame

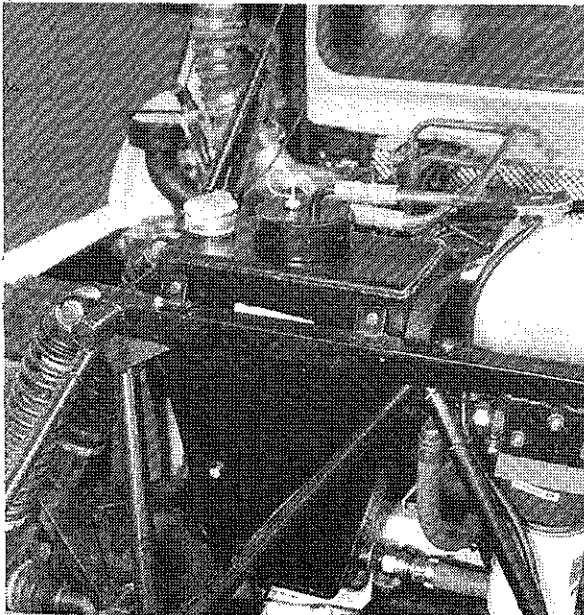

Underside of chassis

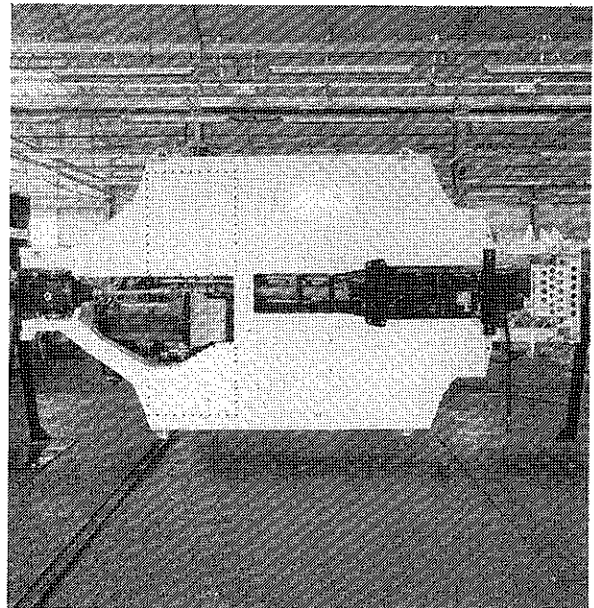

WWW.RS200.ORG

Cylinder head/camshaft cover

It will be necessary, at scheduled service intervals, to remove this cover, so as to inspect the condition of the valve gear, and check the valve clearances, while the engine is *in situ*.

Proceed as follows:

Removal

1. Unlatch, lift and prop the rear body section. However, because of the position of the engine in the engine bay, it may be preferable to remove the rear body section completely. (See the Bodywork section of this part of the manual).
2. Remove spare wheel and carrier.
3. Disconnect the turbocharger support link from the support 'crane'.
4. Remove three nuts retaining the turbocharger support 'crane' to the camshaft cover, and remove the 'crane'.
5. Remove the three support 'crane' studs from the camshaft cover.
6. Disconnect the spark plug leads, and lay them to one side. If they are not already individually identified, mark up their correct cylinder positions.
7. Disconnect the engine to oil tank breather pipe, and bung its end.
8. Remove the camshaft drive belt top cover fixings, but leave the top cover in place.
9. Remove the five remaining camshaft cover screws.
10. Now slide the camshaft cover away from the camshaft belt cover (i.e. - towards the front of the car), and remove it from the car.
11. The camshafts and the valve gear are now exposed, for attention.

Before re-assembly, the area should be cleaned thoroughly, and a new gasket and sealant should always be employed. The following special checks should also be made:

- a. The camshaft fore-and-aft location keys, which are situated in the camshaft bearing bosses closest to the drive pulleys, must be correctly located.
- b. The cam case sealing plug lock pins must be in their correct positions. Any missing pin must be located before the engine is fired up, or serious damage to the engine may occur.

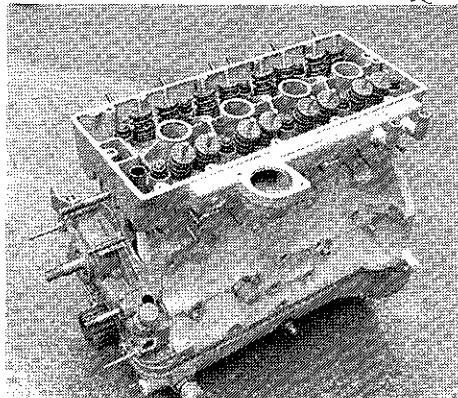

Valve clearance adjustment

The valves are actuated directly from the twin overhead camshafts, by inverted bucket tappets operating on to the valve stems, but separated from them by valve shims.

The valve clearance should be measured between the heel of the camshaft lobe, and the face of the tappet, and should be measured with the engine COLD. Adjustment is made by altering the thickness of the shim under the appropriate tappet.

For the standard-specification RS200, the valve clearances should be, inlet 0.18 to 0.23mm (0.007 to 0.009in.), and exhaust 0.25 to 0.30mm (0.010 to 0.012in.). In order to check these clearances, remove the camshaft cover (already described), and turn the camshaft until the toe of the cam is at 180 deg. to the tappet being checked.

Select a feeler blade (or blades) that can just be inserted between the tappet and the heel of the cam, to measure the clearance. Note the clearance and repeat the procedure for all 16 valves.

If the clearances require adjusting, the camshaft carrier must be removed.

Engine on a stand

1. Remove the plug leads, and the cap from the distributor
 2. Remove the camshaft cover (described elsewhere)
 3. Slacken and remove the alternator drive belt
 4. Remove the water pump drive pulley (4 bolts)
 5. Remove the crankshaft pulley bolts (3 bolts - but not the centre bolt)
 6. Remove the camshaft drive belt outer covers
 7. Rotate the engine to Top Dead Centre, using the TDC marks on the camshaft drive pulleys
 8. Loosen the belt tension adjuster eccentric lock nut, and remove the adjuster from the engine
 9. Note: From this point on, do not allow the camshaft, or camshafts, to be rotated relative to each other, or possible damage may occur due to valve-to-valve, or valve-to-piston contact
 10. Remove the camshaft drive belt. Ideally, it is recommended that a new drive belt should be fitted when the engine is re-assembled. If this is not, however, practical, the existing belt should be checked carefully, to ensure that it is clean, and free from damage
 11. Remove the camshaft pulley centre bolt and washer from both pulleys. Do not allow the camshaft to rotate during this manoeuvre (see (9), above)
 12. Using a special tool - camshaft pulley remover, No. 6182 - screw this tool to each pulley boss in turn, and progressively remove the pulley from its taper. Remove the key from its slot, noting the direction of offset, if any, and to which camshaft it belongs
 13. Remove three water pump retaining bolts, and the steel ring, retaining the camshaft belt inner cover. At the same time, remove the water pump body. Carefully inspect the O-ring seal, and re-new it if necessary
 14. Remove the inner cover
 15. Fit a set of suitable camshaft tappet bucket retaining clips, to ensure that the buckets do not become detached in future operations
 16. Slacken and remove all the cam carrier bolts, except the centre row end bolts
 17. Evenly undo the end bolts, one turn each, at a time, and remove the bolts
 18. Smoothly raise the cam carrier assembly clear of the engine, at the same time inverting it, and place it on a work-bench
 19. Under normal circumstances, all the shims should remain in position, on their valve stems
 20. Replace any shims (which have been displaced in carrying out Operation 20) onto their correct valve stems
 21. The correct valve clearance is now obtained by fitting different thickness shims, as appropriate, to the valve stem heads. To increase the clearance, fit a thinner shim; to decrease the clearance, fit a thicker shim. Measure the shim thickness with an accurate micrometer.
- Note: Deeply recessed shims **MUST** be used for exhaust valves, and should be used for inlet valves. On no account fit shallow shims to the exhaust valves.
- On refitting shims, lightly oil the valve stem heads, to 'stick' the shims in position during re-assembly.

Before commencing re-assembly, please note:

Relocating the carrier to the cylinder head dowels may be made easier if guide studs are temporarily screwed into the centre end threads. The bolting down process may then be begun, half a turn at a time, using the two centre row bolts next to the guide studs. Then quickly replace the remaining cam carrier bolts, to minimise all stresses on the casting and mechanism.

At all times, when moving the cam carrier about the workshop, ensure that each camshaft locating key is in position, and that each camshaft sealing plug retaining pin is also in place. (In each case, this may be ensured by lightly centre-dotting the casting, close to their position).

Do not fire up the engine until oil has been squirted on to the camshaft lobes, tappets, and adjacent camshaft bearings.

Before completing the rebuild, temporarily complete front end assembly without the camshaft drive belt covers, fit and adjust the drive belt, re-time the engine, rotate the engine two complete cycles to settle down its clearances, then check all the valve clearances.

If the clearances are not satisfactory, the engine must again be stripped down for the necessary work to be repeated.

Re-assemble in the reverse sequence.

NOTE: On the RS200 there is no gasket between the cam carrier and the cylinder head casting. Accordingly, on re-assembly, use a silicone based sealer to smear on the mating surfaces, ensuring that none of this compound finds its way into any of the engine oilways.

After tightening down the cam carrier bolts to a torque of between 1.00 and 1.40 kg.m (8 to 10 lb.ft.), the cam cover may finally be refitted, using a new cork gasket.

After all re-assembly, and adjustment, has been completed, torque up the cam cover bolts to 0.55 to 0.83 kg.m (4 to 6 lb.ft.)

Camshaft Drive Belt

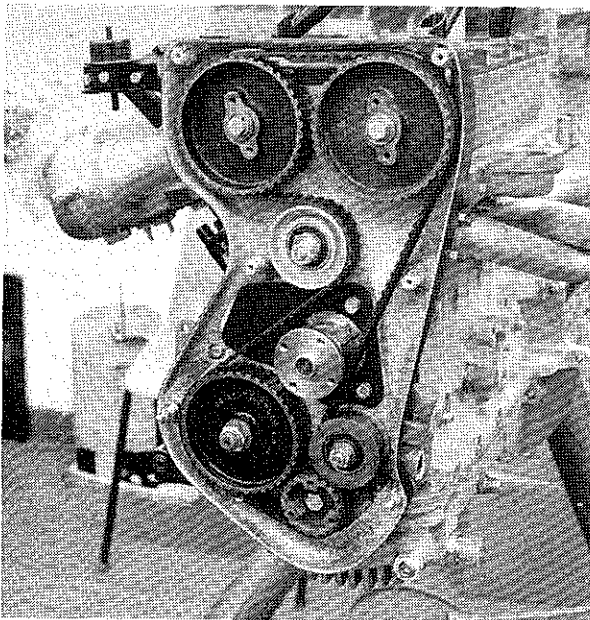

Cylinder head layout

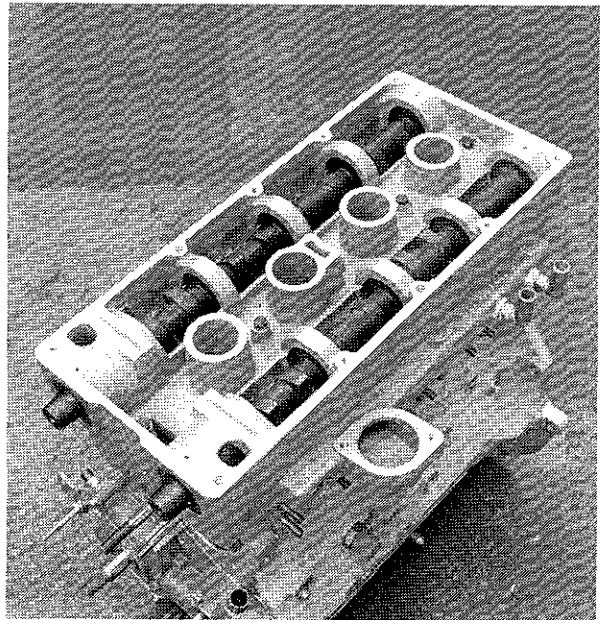

Bucket retaining clips

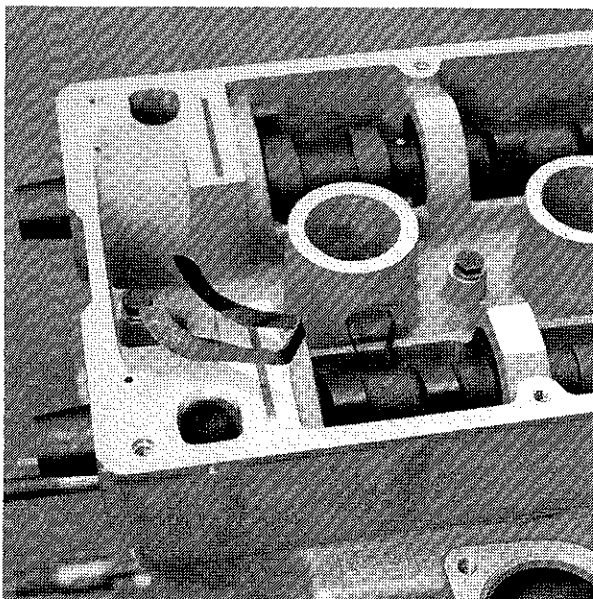

After removal of cam carrier

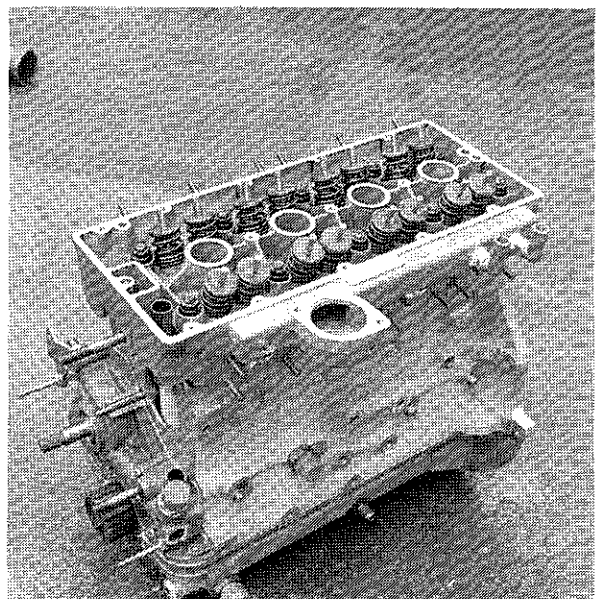

Camshaft drive belt

The single drive belt is internally toothed, and drives the twin overhead camshafts, at half-engine speed, from a pulley on the crankshaft, via a pulley on the auxiliary shaft, and a tension adjusting idler. A second idler provides the necessary belt wrap-around for the crankshaft pulley.

To adjust the drive belt tension

1. Slacken and remove the alternator drive belt
2. Remove the water pump drive pulley (4 bolts)
3. Remove the crankshaft pulley bolts (3 bolts - but not the centre bolt) and remove alternator drive belt pulley.
4. Remove the two (upper and lower) camshaft drive belt outer covers
5. The belt and its adjusters are now exposed, ready for attention
6. Rotate the engine forwards until No. 1 piston is at Top Dead Centre on the compression stroke. At this point the timing marks on the end of the camshaft pulleys will be aligned.
7. Check the belt tension with a Burroughs gauge between the exhaust camshaft pulley and the second idler. The tension should be between 75 to 80 Burroughs Units.
Alternatively: The tension may be checked by measuring the deflection, or total lateral movement, half way along the longest run of the belt. This should be 20.0mm (0.75in.) with all the slack on the longest belt run.
8. If the belt tension is incorrect, slacken off the adjuster locknut on the eccentric pulley, and adjust as necessary, then re-tighten the locknut.
(The eccentric pulley is that placed immediately below the two camshaft pulleys)
9. Repeat Operation Nos. 6 and 7, to recheck that the correct tension has been established, and repeat the job if it has not.

Removal of the belt

Repeat Operations Nos. 1 to 6 (above)

10. Slacken off the adjuster pulley, and pull it off the stud. The belt may now be removed, along with the idler pulley.
11. Note: From this point on, do not allow the crankshaft, or the camshafts, to be rotated relative to each other, or possible damage may occur due to valve-to-piston contact.

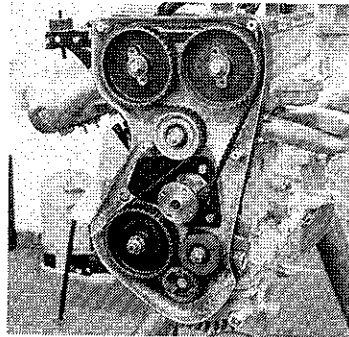

Re-assembly

1. Ideally, a new drive belt should be fitted, though if the existing belt is seen to be in good condition, after a careful inspection, it may be used once again.
2. Thoroughly de-grease the toothed pulleys, and spray them lightly with a pure molybdenum disulphide air-drying bonding resin.
3. Ensure that all the pulley timing marks are correctly aligned, with No. 1 piston (which is closest to the cam drive belt end of the engine) at Top Dead Centre on the compression stroke.
4. Refit the belt without disturbing the timing.
5. Refit the idler pulley and the eccentric adjuster pulley, and make a temporary adjustment.
6. Manually turn over the engine, through one complete cycle, before finally setting, adjusting, and checking, the tension of the camshaft drive belt. Complete re-assembly in reverse sequence.

Engine camshaft

The two overhead camshafts are mounted in the cylinder head, and are exposed to view as soon as the cam cover has been removed.

It may be necessary to remove a camshaft - for instance, when power tuning the engine, and substituting a different component. This should be done after the engine has been removed from the car, and is on a work stand.

Camshaft removal

Special tool: A camshaft pulley remover, No. 6182, is required

1. Remove the plug leads, and the cap from the distributor
 2. Remove the oil drains from the camshaft cover, and remove the cover itself
 3. Slacken and remove the alternator drive belt
 4. Remove the water pump drive pulley (4 bolts)
 5. Remove the crankshaft pulley bolts (3 bolts - but not the centre bolt), and remove the pulley itself
 6. Remove the camshaft drive belt outer covers
 7. Rotate the engine to Top Dead Centre, using the TDC marks on the camshaft drive pulleys
 8. Loosen the belt tension adjuster eccentric lock nut, and remove the adjuster from the engine
 9. Note: From this point on, do not allow the crankshaft, or the camshafts, to be rotated relative to each other, or possible damage may occur due to valve-to-valve, or valve-to-piston contact
 10. Remove the camshaft drive belt
 11. Remove the camshaft pulley centre bolt and washer from both pulleys. Do not allow the camshafts to rotate during this manoeuvre (see (9), above)
 12. Using a special tool, No. 6182, screw this to each pulley boss in turn, and progressively remove the pulley from its taper. Remove the key from its slot, noting the direction of offset, if any, and to which camshaft it belongs
 13. Remove three water pump retaining bolts, and the steel ring, retaining the camshaft belt inner cover. At the same time, remove the water pump body. Carefully inspect the O-ring seal, and re-new it if necessary
 14. Remove the camshaft belt inner cover
 15. Using a small piece of rag, blank off the unused cylinder head drain hole, which is on the inlet side of the cam carrier
 16. Fit a suitable set of camshaft tappet bucket retaining clips, to ensure that the buckets do not become detached in future operations
 17. Slacken and remove all the cam carrier bolts, except the centre row end bolts
 18. Evenly undo the end bolts, one turn each, at a time, and remove the bolts
 19. Smoothly raise the cam carrier assembly clear of the engine, at the same time inverting it, and place it on a work bench
 20. Under normal circumstances, all the valve shims should remain in position, on their valve stem heads
 21. Replace any shims which have been displaced in Operation No. 20, on to their correct valve stems
 22. Remove the bucket tappet retaining clips, then remove, inspect, and identify all 16 bucket tappets.
- Note: On re-assembly, ensure that each bucket is lightly oiled, and that the correct bucket is returned to the casting bore from which it was originally removed.
23. Turn over the cam carrier
 24. Extract the pin locating the rear sealing plug, remove the crescent-shaped thrust washer from near the front of the cam carrier, and extract the camshaft towards the rear of the engine, pushing out the sealing plug in the process.
 25. Push out the front oil seal from the carrier.

Re-assembly

1. Refit, lubricate and locate the new camshaft in the cam carrier
2. Fit a lightly oiled new oil seal. Push it deeply into its housing, and tap it gently forwards, towards the drive belt end of the engine, with the camshaft itself, until the front face is flush with the bottom of the chamfer in the carrier
3. Re-fit the crescent-shaped thrust washer
4. Re-fit the sealing plug, using a lightly-oiled new O-ring, in the rear of the carrier, and locate it with the small pin. The pin may be locked into place by lightly centre-punching into the casting close to it.

Complete re-assembly in reverse sequence, noting that the torque setting for the centre bolt holding the camshaft drive pulley to the camshaft itself should be torqued up to 2.7 to 3.5 kg.m (20 to 25 lb.ft.) Check, and if necessary, re-set all the valve clearances, and adjust the belt tension, before using the engine again.

Do not fire up the engine until oil has been squirted on to the camshaft lobes, tappets, and adjacent camshaft bearings.

Upgrading for serious Motorsport

One way to increase the power of the RS200 engine is to fit camshafts having revised lift profiles. For details, see the Optional Ford Motorsport Parts section.

Camshaft drive belt details

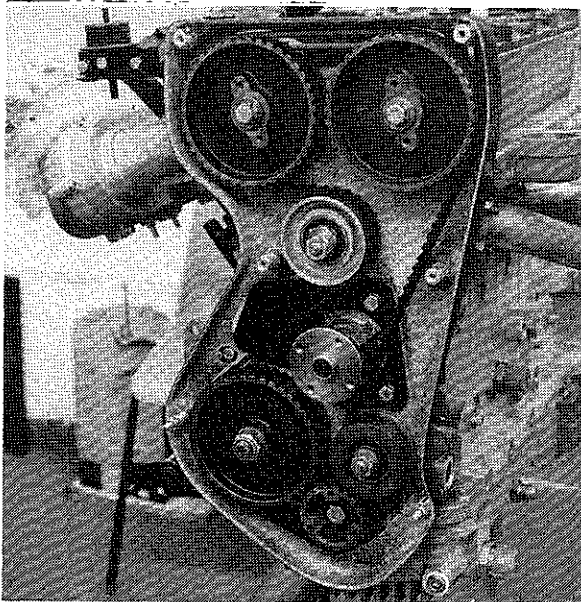

Bucket retaining clips in place

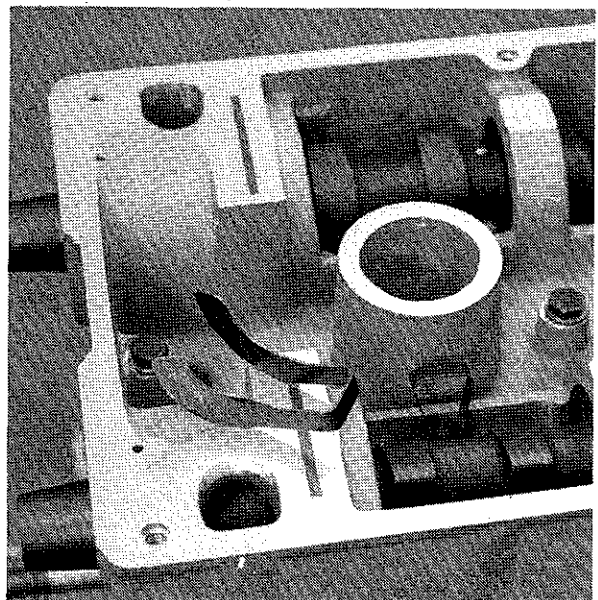

Camshaft installation

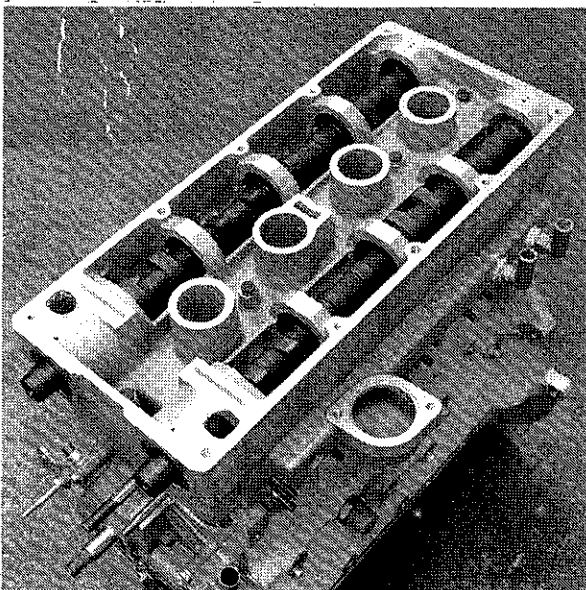

Cylinder head gasket

To change the cylinder head gasket, it is necessary to dismantle the camshaft belt drives, and the camshaft pulleys themselves.

Gasket change

Note: It is assumed that the entire exhaust system, the entire inlet manifold, and fuel injection equipment, has already been removed.

If a cylinder head gasket fails it is likely that there will be resulting damage to the faces of the cylinder head and block in the vicinity of the failure. This is due to the relatively high operating temperatures of a turbo charged engine.

Before re-assembling the cylinder head to the block it is important to check that mating surfaces are true.

1. Ensure that the engine has been drained of its cooling water
2. Dismantle the drive belt covers, the belt, and the camshaft pulley wheels (see 'Camshaft removal'), and remove the cam carrier, complete with all camshafts, and inverted bucket tappets (already described).
3. Disconnect all oil drain tubes from the head casting
4. Identify, and remove, all valve gear shims, placing them, for safe keeping, inside the buckets in the inverted cam carrier, which is already removed
5. Disconnect the exterior water rail (two screws), from the water transfer casting, which is at the rear of the engine
6. Disconnect the water transfer casting (four screws) from the rear of the block
7. Gently withdraw the water transfer casting from the cylinder head connecting tubes. Discard all five O-rings, and on re-assembly fit a new set.
8. Slacken off the cylinder head nuts evenly, and remove the cylinder head, over the studs.
9. Separate the old gasket from the cylinder block, and discard it. Before proceeding further, carry out a careful visual check of mating cylinder block and cylinder head faces, for cracks, or corrosion, and clean both surfaces before commencing re-assembly.

Re-assembly

1. Lightly oil the cylinder head studs before beginning re-assembly. Do *not* use any anti-seize compound, as this will affect the torquing down process at a later stage.

Re-assemble in reverse sequence by fitting the new cylinder head gasket, and ensuring that a set of new O-rings is available for the water transfer casting at the rear of the head casting.

Note: It is essential to check and adjust the valve clearances during re-assembly. See 'Adjusting Valve Clearance' for procedural details.

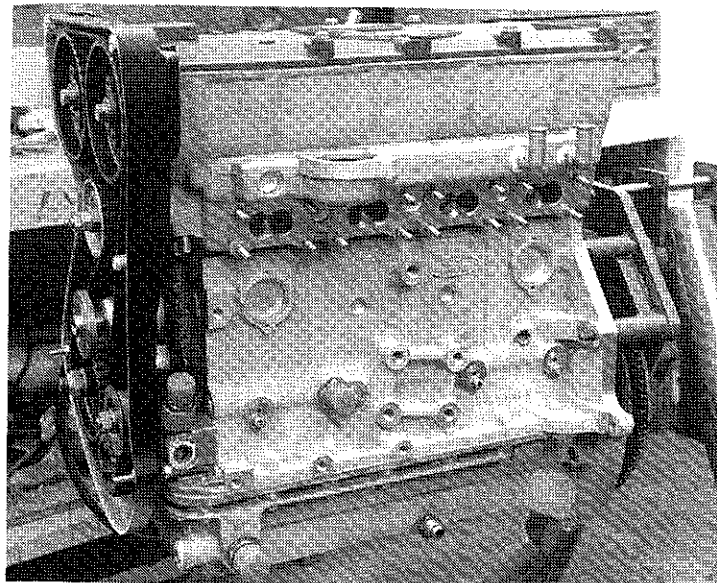

Air cleaner

The air cleaner element is a dry foam-type of unit, and is mounted in a container positioned at the right of the engine compartment, immediately behind the passenger bulkhead, and close to the turbocharger installation.

Fresh air is drawn in from the air intake behind the right side passenger door, passes through the cleaner element, and is then directed to the inlet passage into the turbocharger compressor.

If the RS200 is regularly used in dusty conditions, or is habitually driven through mud, or other unmade surfaces, the air cleaner will do its job by collecting significant quantities of grit, or other foreign matter. Inspections should be carried out according to the recommended service schedule, but much more frequently if the car is used over the surfaces described above.

To inspect, and change the element.

1. Unlatch, raise, and prop the rear body section.
2. Unlatch the lid to the air cleaner container, by loosening four over-centre toggle clips.
3. Remove the container lid.
4. Remove the spacer at the rear of the air cleaner element, which holds it in place.
5. Slide the air cleaner element slightly rearwards, to remove it from the support spigot at the front of the container box.
6. The element may now be removed, cleaned and - if necessary - re-newed.

Before re-assembly, clean out the base of the container itself.

Re-assemble in the reverse sequence.

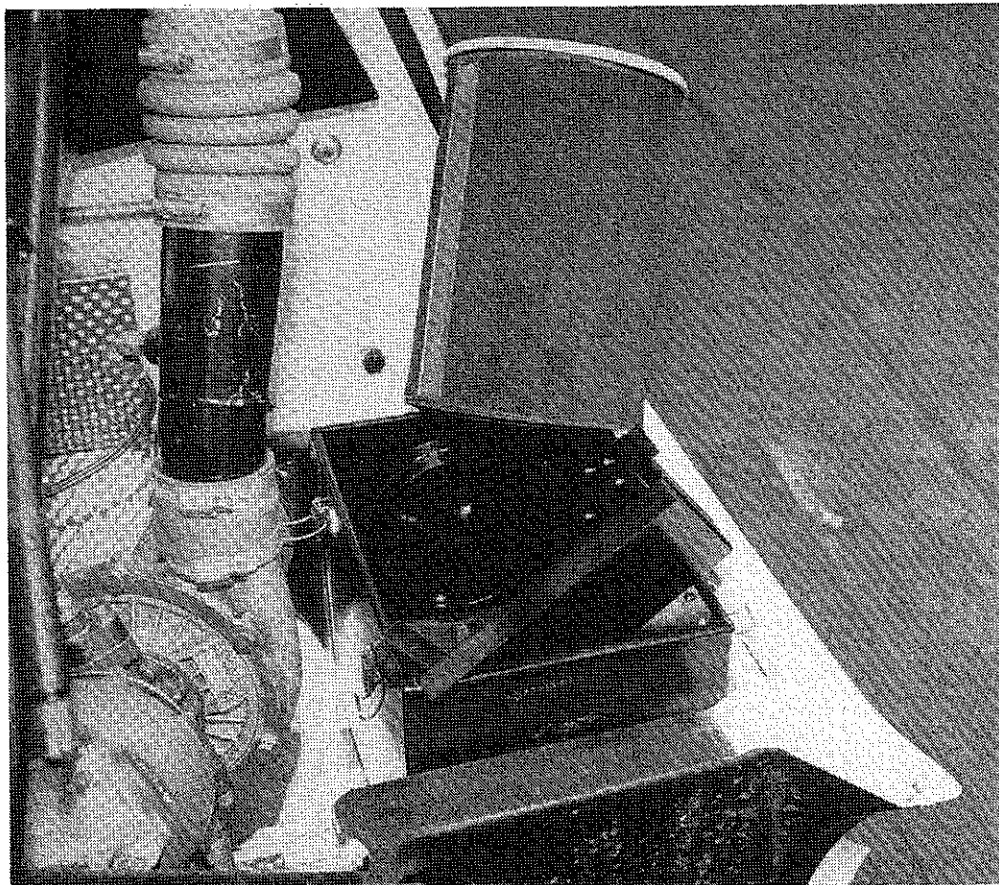

Intercooler

In a turbocharged engine, when the inlet air is compressed, it also heats up. The function of an intercooler, therefore, is to cool down the compressed air before it reaches the inlet manifold.

On the RS200, an intercooler is mounted in the air passage between the turbocharger and the inlet manifold, and is positioned above and behind the roof of the car. It takes the form of a radiator matrix, and cooling is by the rush of fresh air channeled through the matrix by the scoop immediately behind the roof. Because the intercooler is mounted high up, it is well clear of mud and flying stones thrown up by the passage of the car, but it is still likely to receive quantities of dust if the car is habitually driven on unsurfaced roads in a dry climate. At regular intervals, therefore, ensure that the air passages of the intercooler are clear, and flush them out if necessary, as you would with a conventional water cooling radiator.

Removal

1. Unlatch and raise the rear body section, propping it securely.
2. Disconnect the body section gas struts, to give better access to the intercooler fixings.
3. Disconnect the flexible hose connections at each side of the intercooler assembly, then seal off these hose holes, to ensure that no foreign matter can enter the engine, or fall back into the turbocharger.
4. Undo the four flexible intercooler mountings (two each side of the unit, to the tubular sub-frame).
5. Lift and remove the intercooler from the car.

Reassemble in the reverse sequence. On re-assembly, ensure that no stones or other debris have been trapped between the intercooler matrix and the body panel beneath it.

At this time it is also recommended that you inspect all the flexible hoses and clips for function, and renew them if necessary.

Upgrading for serious motor sport

For certain conditions of sporting use, particularly in a higher state of engine tune, and in hot climates, a larger-capacity intercooler may be needed.

See *Optional Ford Motorsport Parts* section.

Intercooler installation

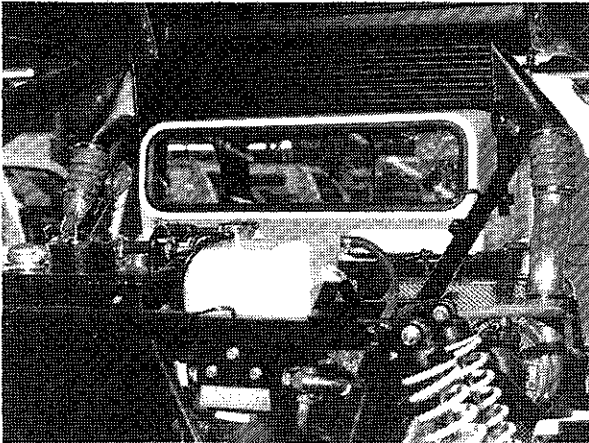

Intercooler mountings

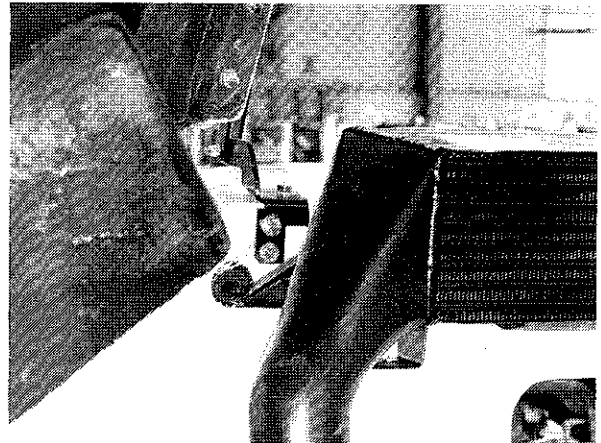

Inlet Manifold, and 'O'-Rings

On the RS200, the inlet manifold is situated on the left side of the engine, and is connected by flexible trunking to the air-to-air intercooler mounted above and behind the roof of the passenger compartment. No service or maintenance of the manifold itself is required, but occasionally it may be necessary to change a manifold/cylinder head O-ring. There are four such O-Rings - one to each inlet port.

Changing the O-rings

1. Unlatch, lift, and prop the rear body section
2. Remove the inlet manifold support brace. This links the manifold to the near-side engine mounting.
3. Remove the breather pipe connecting the manifold to the cylinder head camshaft cover.
4. Disconnect the flexible pipe connection to the intercooler, and cover the end of this pipe, and the open end of the manifold, with tape, to ensure that no foreign bodies are accidentally ingested.
5. Undo all 10 manifold/cylinder head retaining nuts.
6. Carefully withdraw the manifold from the studs. It is not necessary to remove the fuel injection system's piping from the manifold, or to remove the assembly from the car.
7. Remove all four O-rings (It is not recommended that a single O-ring be changed)

Re-assemble in the reverse sequence. However, before fitting new O-rings, carefully clean the mating surfaces, and ensure that no dirt or foreign matter enters the inlet tracts.

Exhaust manifold

On the RS200, a tubular exhaust manifold is fitted. This is a complex unit, because it also has connections to the turbocharger unit, and is mounted on the right side of the engine bay.

The exhaust manifold becomes extremely hot in this application. Because of this, and because it also has to support the turbocharger assembly, it is recommended that regular checks should be made for cracks, especially at welded joints between tubes and plates, or tubes and tubes. Removal may be necessary, to exchange a set of manifold gaskets.

Removal

Note: Do not attempt to remove the exhaust system when it is hot.

1. Unlatch, lift and prop the rear body section.
2. Remove the exhaust system (described elsewhere)
3. Remove the turbcharger assembly (described 07-16.)
4. Remove the piping from the turbocharger dump valve, which is adjacent to the turbocharger itself.
5. Undo all 16 exhaust manifold retaining nuts.
6. Withdraw the manifold (including the dump valve assembly), over the studs.
7. At all times ensure that no foreign matter is allowed to enter the cylinder head tracts, or the manifold tubes themselves. Double check when re-assembling the system.
8. Remove the set of four gaskets. It is recommended that a complete set should be exchanged, even if only one requires attention.

Re-assemble in the reverse sequence. However, before fitting new gaskets, carefully clean the mating surfaces, and use new seals and sealants at the turbocharger mating face to the manifold.

WWW.RS200.ORG

Inlet manifold installation

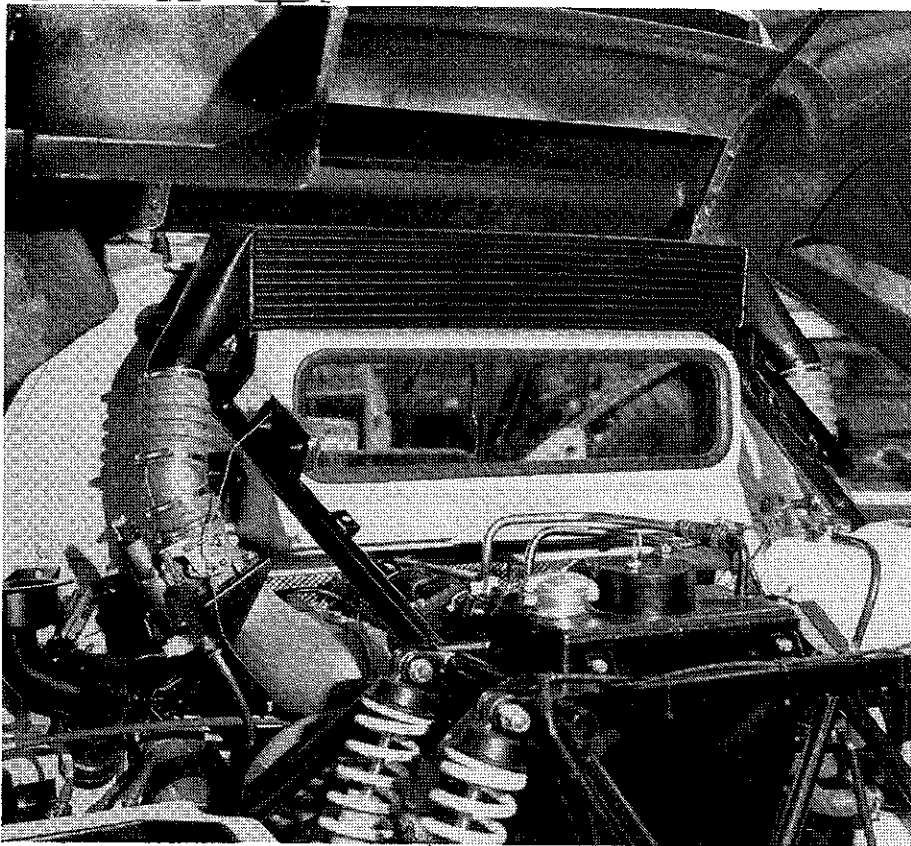

Inlet manifold removal

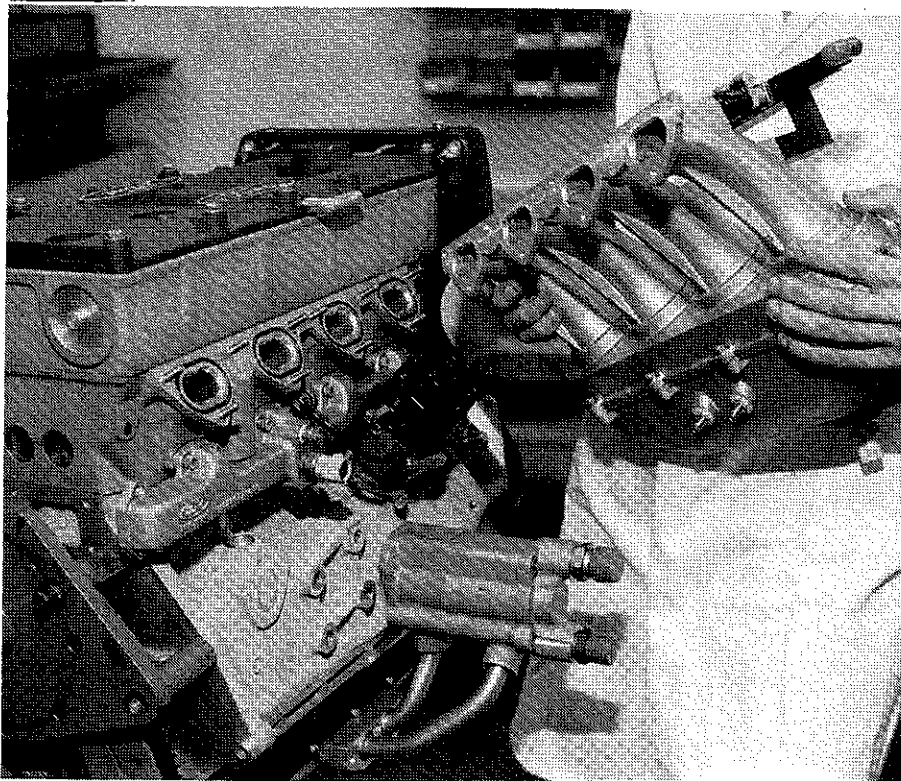

WWW.RS200.ORG

TURBOCHARGER

The function of a turbocharger is to use the energy of the expelled exhaust gases to help push more air into the engine. In effect, a turbocharger is an exhaust-driven turbine wheel, mounted back to back with a compressor for the inlet air. For the RS200, an AiResearch T31/T04E unit is used.

This is fixed to the exhaust manifold of the engine, and is situated to the right of the engine compartment. Fresh air is drawn through the air cleaner mounted behind the passenger bulkhead on the right of the car, and pressurised air is pushed through the air-to-air intercooler (mounted above and behind the roof of the car), to the inlet manifold, which is at the left side of the engine.

The turbocharger begins to deliver positive boost pressure from approximately 2,500 engine rpm, and the maximum boost is limited to 0.75 Bar (11.0 psi).

Lubrication of the turbocharger bearings is ensured by a flow of engine oil, through armoured flexible hoses. Accordingly, no special maintenance measures are required. Ensure, however, that the pipe connections are always securely tight, and that there is no leakage at the joints with the exhaust manifold-ing, and the pipes from the air cleaner, and to the intercooler.

For advice on how best to treat the turbocharger, when driving hard, see DRIVING THE CAR.

Removal

IMPORTANT: In use, the turbocharger assembly becomes extremely hot. Do not attempt to work on a hot turbocharger. Allow it to cool off, before any work commences.

1. Unlatch, and raise the rear body section, propping it securely.
2. Disconnect the oil feed pipe to the turbocharger assembly. This is a small bore pipe on top of the unit.
3. Disconnect the oil return pipe, which is underneath the unit.
4. Disconnect the turbocharger support link from the tubular 'crane'.
5. Disconnect the piping from the air cleaner to the turbocharger compressor inlet.
6. Disconnect the trunking to the roof-mounted intercooler.
7. Undo the four fixings which secure the turbocharger body to the exhaust pipe.
8. Remove the four bolts holding the turbocharger unit to the exhaust manifold.
9. Remove the turbocharger from the engine compartment.

Note: At all stages, take great care not to damage the turbine blades.

Reassemble, in the reverse sequence. When refitting, use a new set of seals and gasket joints, and always use a suitable high-temperature sealing compound at the turbocharger/manifold joint. Care must be taken to ensure that oil feed and return pipes are not allowed to come into contact with turbo charger or exhaust manifolding. They should always be at least 75 mm away from these high temperature components.

Uprating for serious motor sport

To increase the engine power for motor sporting purposes, it is possible to fit a turbocharger offering up to 1.5 Bar (22 psi). See *Optional Ford Motorsport Parts* section.

Turbocharger installed

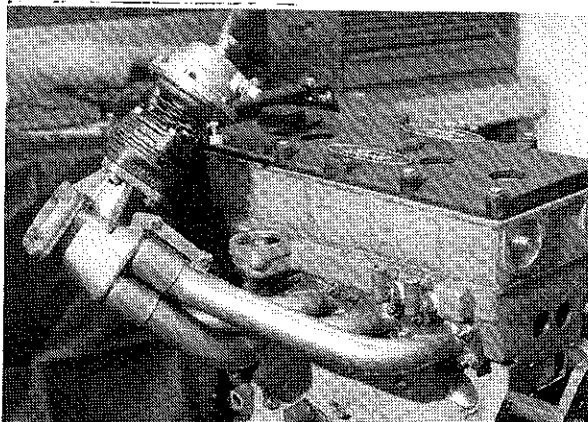

Turbocharger and manifolding

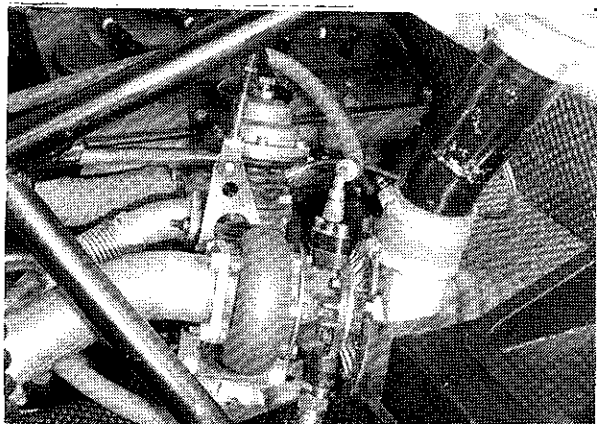

EXHAUST SYSTEM

Although the RS200 is intended to become a competitive rally car, it is fitted with an exhaust system which meets all legislative standards. Accordingly, a large silencer is located at the rear of the car, immediately ahead of the spare wheel mounting cradle.

Because of its location, the exhaust system is unlikely to suffer any impact damage from flying stones, or from rough roads.

Occasionally, however, it may be necessary to strip down the system.

Do not attempt to do this while the exhaust system is hot. Before starting the strip down operation, check that the turbocharger and dump valve assemblies, to which the exhaust system itself is bolted, have also cooled down.

To remove

1. Unlatch, lift, and securely prop the rear body section.
2. Release the spare wheel stowage strapping, and remove the spare wheel. This allows easier access to the silencer supports.
3. Loosen the pipe connection between the downpipe, and the silencer assembly.
4. Disconnect the three rubber insulator supports (two from the top side of the silencer box, one from the bottom side), and remove the silencer box itself.
5. Loosen and remove the exhaust system downpipe from the body of the turbocharger (four nuts) and the blow-off, or dump, valve (two nuts); it may be removed from the car.
6. While the system is removed, it is recommended that the open joints to the turbocharger and dump valve assemblies should be taped over, to make sure that no foreign bodies enter them during servicing operations.

Re-assemble in reverse sequence. However, before doing so, check the condition of the three rubber insulator supports for the silencer box, and re-new them if necessary. For a car of this type it is always advisable to rebuild the system with all new supports and joints.

After re-assembly, start up the engine, and check that there are no 'blowing' joints, and that the alignment is correct, even when the engine twists under maximum torque.

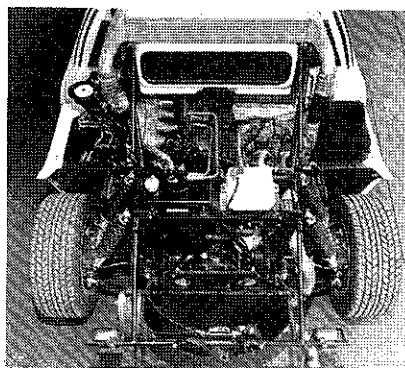
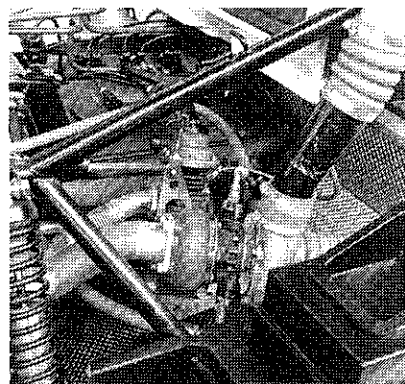
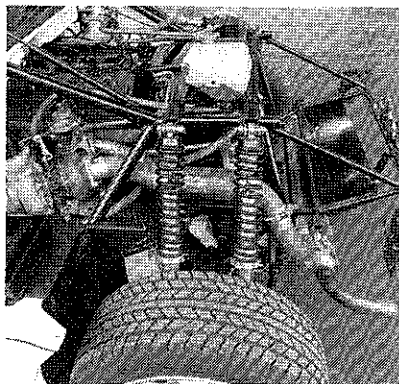

Engine oil tank

Because the RS200 has a dry sump lubrication system, the bulk of the oil is stored in a tank separate from the engine. This is located in the rear tubular cradle, behind the engine, and above the rear final drive. It carries the dipstick for measuring the amount of oil in the system. The oil level should always be measured within 30 seconds, and at normal operating temperature. See FILLING STATION INFORMATION.

Removal

1. Unlatch, lift, and prop the rear body section.
2. Empty the tank by disconnecting the engine feed oil pipe at the entrance to the sump, on the right side of the engine assembly.
3. Disconnect and bung all oil pipe connections, including breathers.
4. Undo five oil tank retaining bolts, and remove the tank upwards out of the cradle.

Re-assemble in the reverse sequence, ensuring that no foreign material enters the tank, or any of the oil lines, and that all the connections are securely fastened. When completely re-assembled, fill the system at once, and run the engine, to satisfy yourself that the lubrication system is working correctly.

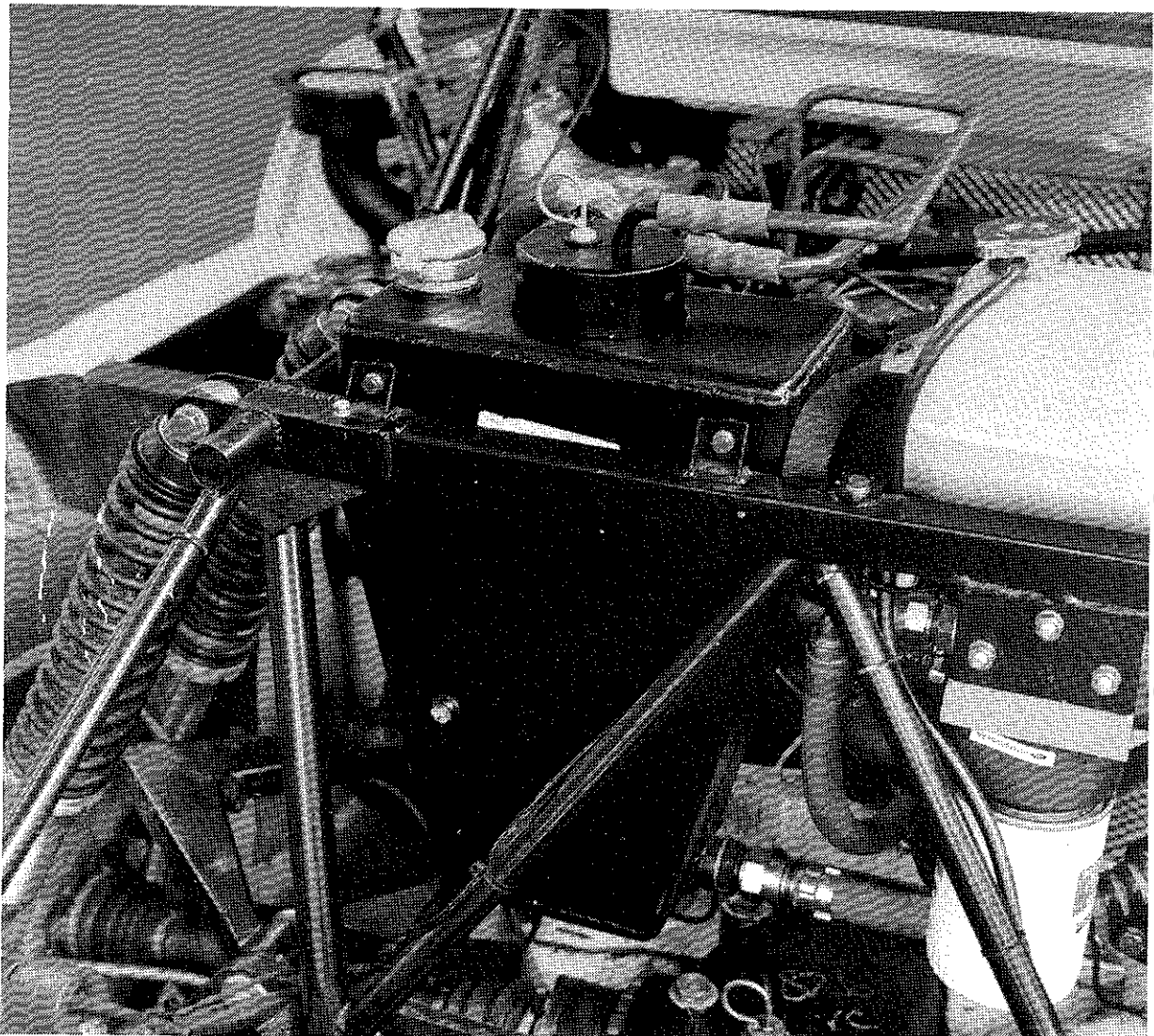

Oil/Water heat exchanger

On a high-performance engine of the type fitted to the RS200, it is essential that the engine oil temperature should be kept at an optimum operating level.

On the RS200, this is ensured by having a large quantity of oil in circulation, together with the use of a dry sump lubrication layout, and by fitting a heat exchanger in the lubrication circuit, mounted immediately above the oil filter canister. This is positioned in the rear tubular cradle, underneath the cooling system header tank, and adjacent to the main engine oil storage tank.

Apart from ensuring that the supplies of engine oil, and of cooling water, continue to flow freely, this component requires no special maintenance attention.

Removal

It is recommended that this should not be tackled when the engine oil, or cooling water, is hot, so that protective clothing and gloves do not have to be worn.

1. To gain easy access, unlatch, lift, and prop the rear body section.
2. Remove the spare wheel from its mounting behind the engine, and tubular cradle.
3. Unscrew the oil filter canister, and remove it downwards.
4. Depressurise the cooling water system, by removing, then refitting, the cooling system header tank filler cap, which is immediately above the position of the heat exchanger.
5. Disconnect and bung the water hoses to the exchanger.
6. Disconnect the central heat exchanger adaptor (access is from its underside).
7. The heat exchanger may then be removed, downwards.

Re-assemble in reverse sequence. When re-fitting, ensure that the seal contact faces are clean and undamaged. After every such operation, it is recommended that new seals should be fitted.

Once re-assembly is complete, check and top-up engine oil, and cooling water levels, then run the engine to make sure that no leaks remain.

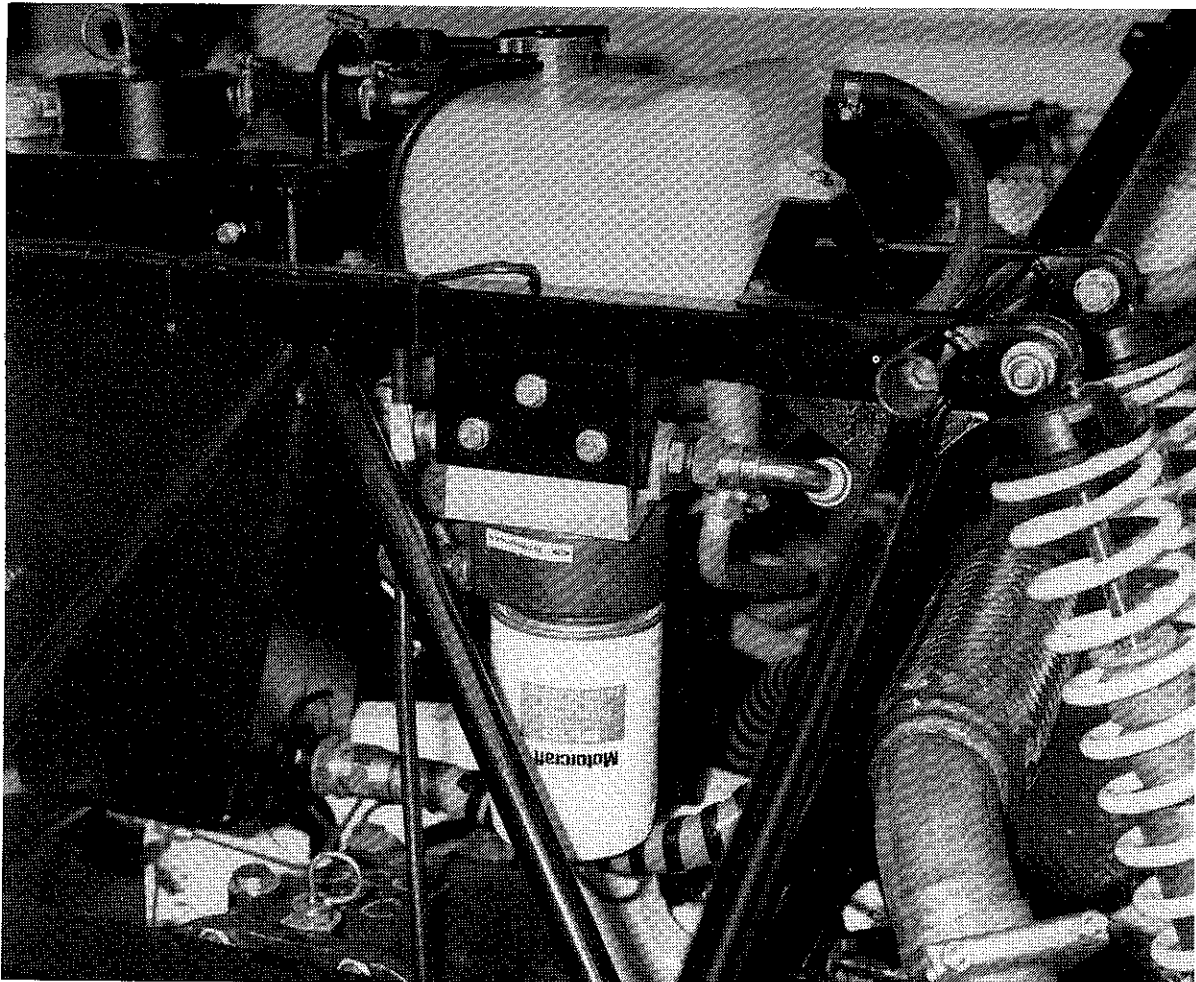

Oil filter

This is a conventional screw-in/screw-out canister, and is located in the rear tubular cradle, underneath the cooling system header tank, and adjacent to the main oil storage tank. It should be re-newed at every major service interval (see SERVICE section).

Removal

1. To gain easy access, unlatch, lift, and prop the rear body section.
2. Remove the spare wheel from its mounting behind the engine, and tubular cradle.
3. Unscrew the oil filter body, and remove it downwards.

Re-assemble in reverse order, taking care that the seal and its contact face with the oil/water heat exchanger is clean and undamaged. Run up the engine as soon as possible, to double-check that there are no leaks.

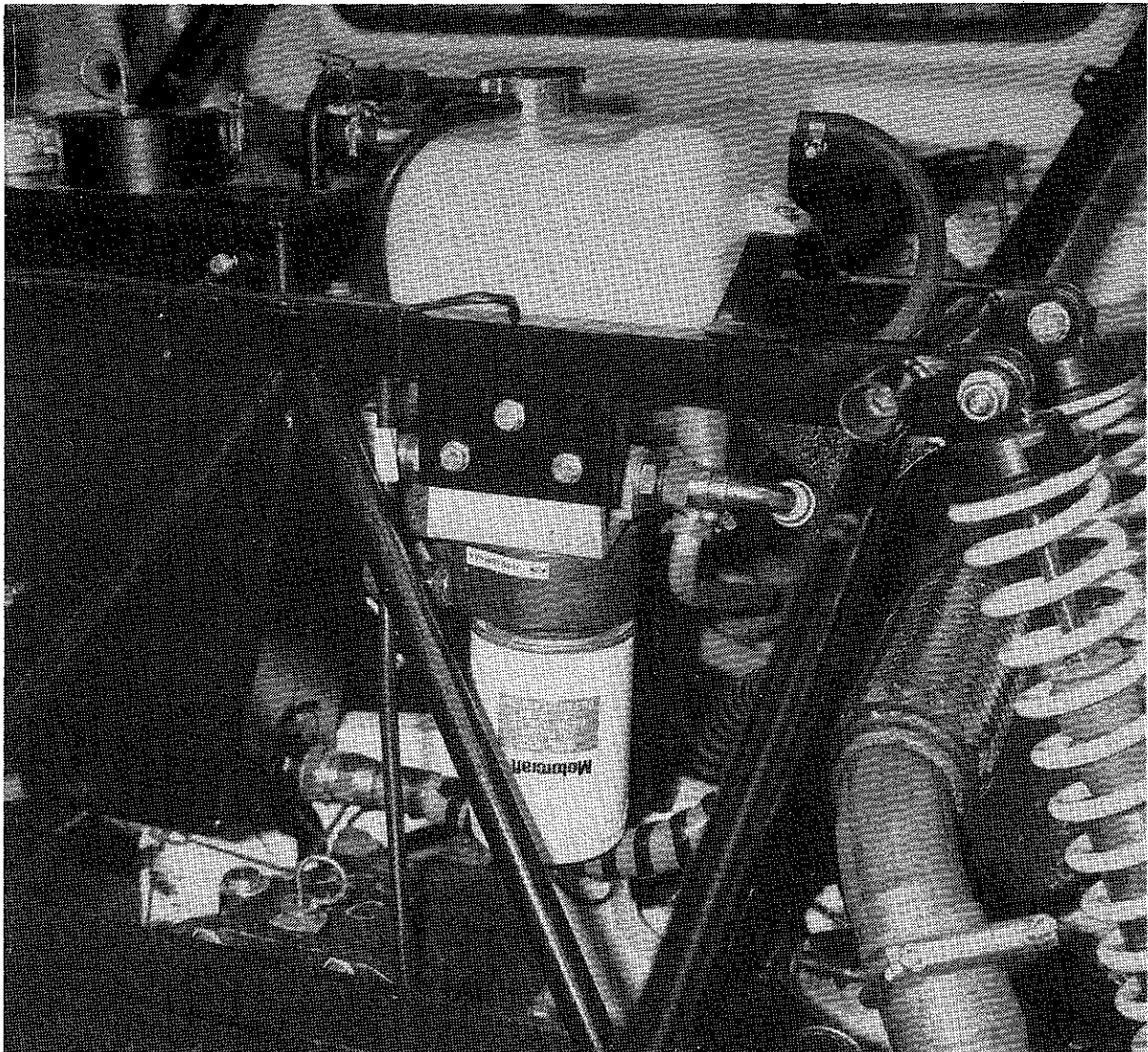

WWW.RS200.ORG

COOLING SYSTEM

INDEX

Cooling system	22
Radiator	23
Thermostat	23
Water pump	24

WWW.RS200.ORG

Cooling system

The engine of the RS200 is situated behind the passenger compartment, and the following cooling system is installed.

The engine itself incorporates the water pump, and the thermostat. The cooling radiator is mounted in the nose of the car. The header tank for the system is located behind the engine, and is positioned in the tubular rear cradle, adjacent to the main engine oil tank. To cool the engine oil, there is a water/oil heat exchanger, mounted below the header tank.

Because the engine's cylinder block and cylinder head are made from cast aluminium alloy, it is necessary to use a 50/50 per cent coolant mixture of water and anti-freeze/inhibitor. It is recommended that this should be changed at least every 60,000 km/36,000 miles, or every two years, whichever occurs first. Use Motorcraft 'Super Plus' antifreeze.

Give individual attention to the components of the cooling system, as follows.

Radiator and electric fan installation

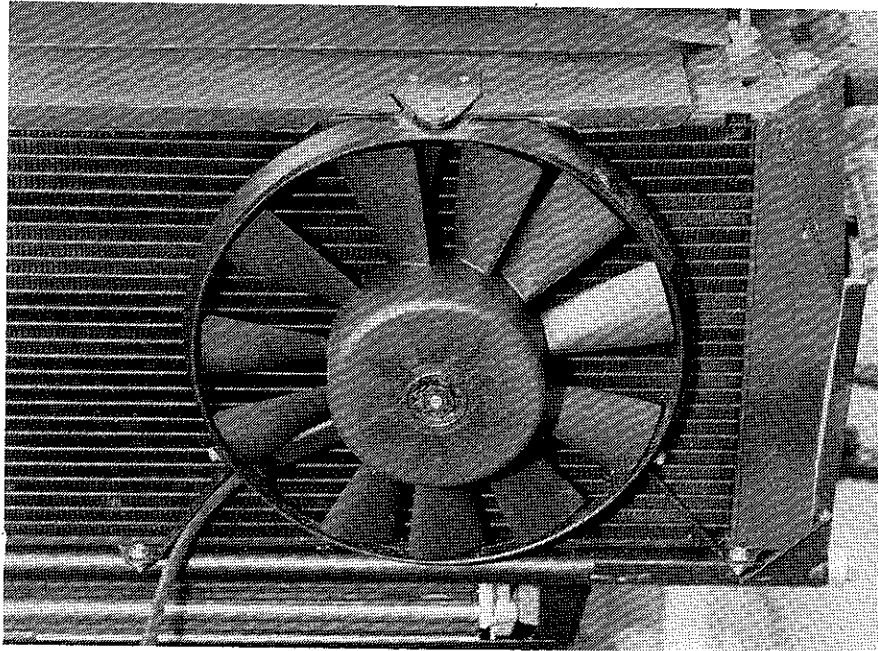

Header tank installation

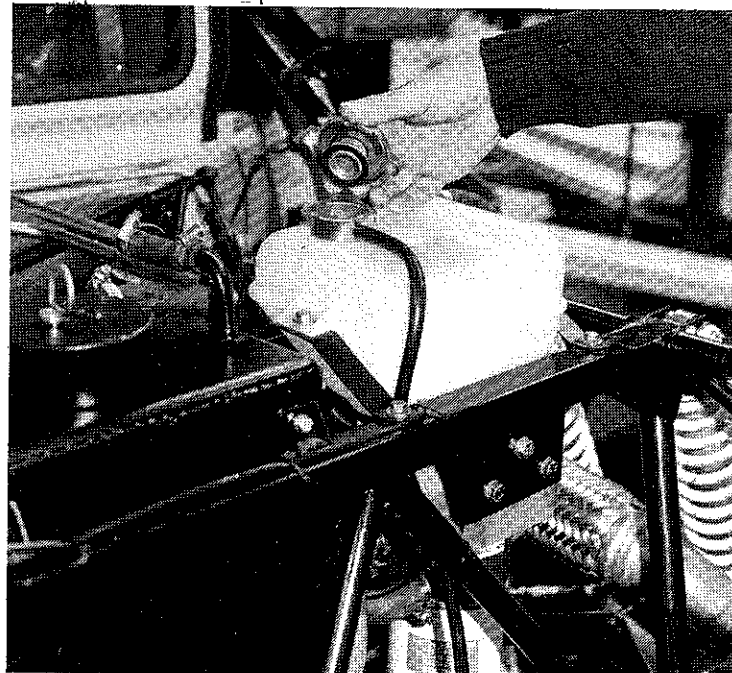

WWW.RS200.ORG

Radiator

This is mounted at the front of the car, low down, ahead of the front body/chassis cross member. It is a cross-flow design, and there is a thermostatically controlled, electrically driven, cooling fan immediately ahead of it.

Removal

Note that it is not necessary to remove the front lift-up body section before removing the radiator, though there is more working space if this is done.

Accordingly:

1. Drain the coolant, by loosening a radiator hose at the side of the radiator.
2. Remove both radiator hose connections - one of the left, and one at the right.
3. Disconnect the glassfibre ducting from behind the radiator, and remove it from the car.
4. Disconnect the electrical wiring from the cooling fan motor, by pulling off the plastic connector (Do not tug on the wire itself).
5. Disconnect the wiring connection to the main electrical loom, which is situated low down, under the radiator support cradle.
6. Remove the two radiator retaining hooks, by loosening wing nuts - one each side.
7. Lift the radiator gently out of its cradle, taking care not to damage the rubber packing pieces on each side of the radiator cradle.
8. Disconnect the fan assembly from the radiator shell, by loosening two screws.
9. Remove the fan thermostatic switch sensor from the rear face of the radiator side tank.

Re-assemble in reverse order, ensuring that the rubber packing pieces in the cradle are not damaged, and that the retaining hooks are correctly located at the bottom, and the wing-nuts tightened down. Refill the cooling system, through the header tank, which is situated behind the engine, in the tubular cradle.

Ensure that the radiator is then bled - there is a bleed screw at the left side of the radiator top. Bleed the heater matrix, which is in the front bulkhead area, close to the windscreen wiper motor position. Re-bleed the heater, with the engine running, and with water circulating.

Thermostat

This is fitted in a chamber at the side of the cylinder head, on the right side of the engine as installed in the RS200.

Removal

1. Unlatch, lift and prop the rear body section.
2. Drain the coolant, by loosening a radiator hose, at the side of the radiator, at the front of the car.
3. Remove the top of the thermostat housing - two screws - and disconnect a water hose clip, to allow the housing to be swung clear.
4. Remove the old thermostat.

To-reassemble:

5. Insert a new thermostat, using a new gasket, and a silicone based sealer.
6. Refix the thermostat top housing, and re-fix the hose and its clip.
7. Refix the radiator hose at the front of the car.
8. Refill the cooling system through the header tank, which is situated behind the engine, in the tubular cradle.
9. Ensure that the radiator is then bled - there is a bleed screw at the left side of the radiator top.
10. Bleed the heater matrix, which is in the front bulkhead area, close to the windscreen wiper motor position. By removing uppermost of two heater hoses and ensuring that water flows from disconnected end and heater matrix.
11. Re-bleed the heater, with the engine running, and with water circulating.

Water pump

The engine cooling system's water pump is located at the front (belt-drive) end of the engine, and is normally hidden away by the drive belt cover. To change the water pump, it is necessary to partially strip down the front end of the engine's drive belt and pulley systems.

Because, in the installed position in the car, these are very close to the structural members of the rear chassis, it is not considered practical for this to be done with the engine remaining in the car. The operations described below, therefore, refer to the engine when out of the car, and on a workshop stand. It is assumed that the water system has already been drained.

Removal

1. Slacken and remove the alternator drive belt.
2. Remove the water pump drive pulley (4 bolts).
3. Remove the crankshaft pulley bolts (3 bolts - but not the centre bolt) and remove the pulley.
4. Remove the camshaft drive belt outer covers.
5. Rotate the engine to Top Dead Centre, using the TDC timing marks on the camshaft drive pulleys to ensure this.
6. Loosen the belt tension adjuster eccentric lock nut, and remove the adjuster centre from the engine.
7. Pull on the long side of the belt to transfer all the belt slack to that side of the assembly. This gives more convenient access to the water pump retaining bolts.
8. Remove the three water pump retaining bolts, and the steel ring, retaining the camshaft belt inner cover. Carefully remove the water pump body - it may be necessary to rotate the body slightly to extract it past the slackened camshaft drive belt. Discard the old O-ring seal which is removed at this point, and prepare to fit a new seal on re-assembly.

Re-assemble in reverse sequence.

Note: When the water pump body has been re-fixed to the engine, transfer all the belt slack to the adjuster side of the assembly before carrying on with the work.

Before closing up the end cover, re-time, and re-adjust, the valve timing as necessary (this is described elsewhere).

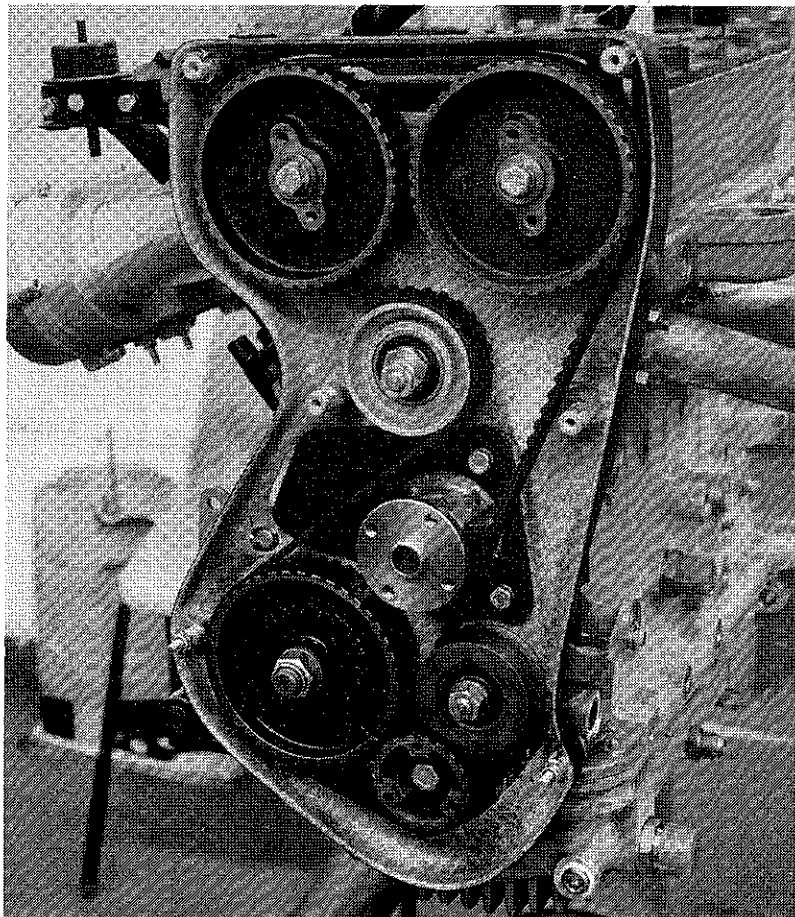

TRANSMISSION

INDEX

Unlocking the transmission mode lever	26
Clutch assembly	27
Clutch master cylinder	28
Clutch slave cylinder	28
Transfer gearbox	30
Primary propellor shaft	31
Transmission assembly	32
Partial strip down of transmission assembly	33
Gear linkage	35
Transmission oil cooler	36
Propellor shaft - transmission to rear final drive	37
Rear wheel final drive assembly	38
Front wheel drive shaft	39
Rear wheel drive shaft	40

WWW.RS200.ORG

Transmission Mode Control – Road Specification Cars

The RS200 is delivered to the owner with the two-wheel-drive/four-wheel-drive control lever removed. This means that the car is supplied in the four-wheel-drive, with 'open' centre differential mode. This has been done, specifically because the RS200 is a very powerful car, with very high performance, and that it exhibits different handling characteristics in two-wheel-drive (rear-wheel-drive) compared with the four-wheel-drive mode which is considered to be its normal, and ideal, configuration. If the owner wants to reinstate the 2/4 lock lever and linkage, parts are available for this purpose.

Unlocking the Transmission Mode Lever – Rally Specification Cars

On rally cars carrying Chassis Numbers 41 to 200, inclusive, the RS200 is delivered with the Transmission Mode lever locked in its central position.

This is to say that the car, in that state, can only be driven in four-wheel-drive, with the central differential in its normal 'open' (Viscous Coupling) condition.

If the owner wishes to unlock the action of the Transmission Mode lever, to allow him to select rear-wheel-drive, or to lock-up the central differential, proceed as follows:

1. On top of the transmission tunnel, inside the cockpit, push back the leather and rubber gaiters surrounding the two gear levers, exposing the four screws and clips holding the gaiters in place.
2. Remove the screws, and withdraw the gaiter.
3. The gear change and transmission mode change linkages are now exposed to view.

(The Transmission Mode Change lever is the short, stubby, lever to the right side of the assembly, closest to the driver's legs on a right-hand-drive car. It pivots on a spindle, in a plate at the rear of the linkage selector housing.

Above the Transmission Mode Lever pivot is a simple screw which locks the housing to the mode lever itself.)

4. To unlock the Transmission Mode Lever, remove the locking screw, which is above the Mode Lever Pivot Spindle itself. The head of the screw is inboard of the housing plate, and no nut or lock washer has to be loosened off first.
5. Check that the Transmission Mode Lever is now free to be moved forward or back, as required. (Note - to move the Lever, it is always necessary to push the lever to the right, to clear the locating pin from the selector quadrant, before moving it forward or rearward.

No further action or adjustment is necessary, and reassembly of the gaiter is in reverse order. Check that both gear lever and Transmission Mode lever operate correctly when re-assembly is complete.

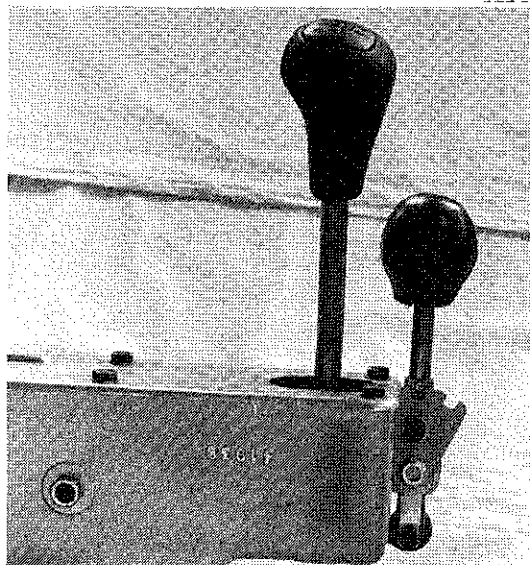

Upgrading for Serious Motorsport

No changes are necessary. The competitor, in fact, will probably choose to unlock the Transmission Mode lever during initial preparation, and leave it like that for the rest of the car's career.

Clutch assembly

The clutch is a diaphragm spring, twin-plate AP-Lockhead unit, with hydraulic actuation. Ceramo-metallic linings are used. The unit itself is mounted inside a light-alloy bell housing at the front of the engine, approximately positioned in the centre of the car.

Whenever the clutch is stripped out for examination, a check should be made for lining wear (the linings are rivetted to the discs), and lining dust should be removed from the central splines, and the peripheral splines of the discs. Clutch adjustment is carried out by altering the length of the hydraulic slave cylinder push rod. This is necessary only when refitting or replacing the clutch assembly. There should be 8 mm to 11 mm free play at the bearing when actuating lever is pushed towards slave cylinder. This applies to a new clutch – when free play is finally taken up the clutch is worn and must be replaced.

Removal

1. Remove the left side passenger seat - four bolts to the floor panel.
2. Peel back the carpet from the transmission tunnel, exposing a removable panel at the rear bulkhead.
3. Undo six screws, and remove this panel.
4. Through the exposed access hole, remove the locknut from the clutch spigot shaft.
5. Depress the clutch pedal, and withdraw the spigot shaft.
6. Remove the clutch slave cylinder - two bolts - access to one being through the hole, to the other from underneath the car.
7. Remove the pushrod.
8. From underneath the car, remove the bell housing bottom cover. There are six bolts.
9. Remove the three bolts retaining the thrust bearing carrier (called the 'trumpet') to the bell housing.
10. Remove the thrust bearing, trumpet, and actuating arm assembly.
11. Remove six cap screws from the clutch cover plate.
12. Remove the cover plate, and clutch disc assembly.

Re-assembly of the clutch is carried out in the reverse order. Ensure that the slave cylinder pushrod adjustment is correct.

Upgrading for serious motorsport

See *Optional Ford Motorsport Parts* section.

Access through car floor

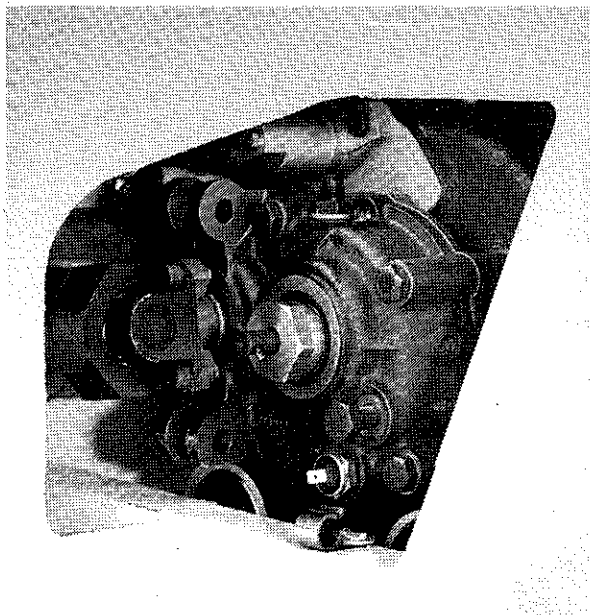

Clutch/transfer box assembly

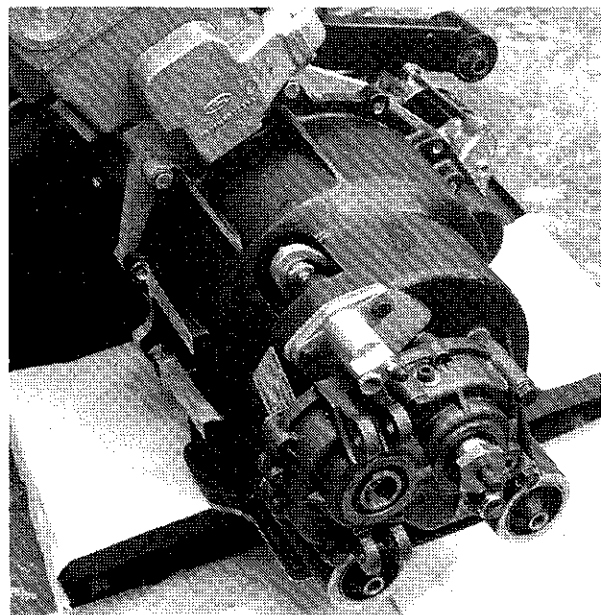

Clutch master cylinder

The hydraulic clutch master cylinder is mounted to the left of the twin brake master cylinders, ahead of the driver's toeboard, and the pedal box, and has its own separate hydraulic fluid reservoir.

On the right-hand-drive cars, the clutch master cylinder is nearest to the centre line of the car. On left-hand-drive cars, the clutch master cylinder is nearest to the outside of the car on the left.

Removal

Note: If any hydraulic fluid is spilt on the paintwork, the affected area should immediately be washed down with cold water.

1. Drain the hydraulic system, by opening the bleed nipple at the slave cylinder. Access to this is by:
 - a) Remove the left side passenger seat. There are four holding down bolts.
 - b) Peel back the carpet on the left side of the transmission tunnel, exposing an access panel at the rear of tunnel.
 - c) Undo six screws, and remove this panel.
2. Pump the system to clear.
3. Remove the bolt from the spherical joint on the pushrod to the master cylinder.
4. Disconnect the reservoir pipe from the master cylinder, and the hydraulic pipe to the clutch, from the master cylinder.
5. Undo both retaining bolts, and withdraw the master cylinder for attention.
6. Note that, for re-assembly purposes, the dimension from the master cylinder/pedal box mounting face to the centre line of the spherical joint should be accurately retained.

Re-assemble in reverse order, bleed in the normal way, and double check for any signs of leakage.

Clutch slave cylinder

The RS200 has hydraulic clutch actuation, with the slave cylinder mounted on the upper right side of the bell housing, close to the centre bearing fixing for the rear transmission propeller shaft.

Access to the slave cylinder is from the inside of the car, by the removable panel on the transmission tunnel.

Removal

1. Remove the left side passenger seat - four bolts to the floor panel.
2. Peel back the carpet from the transmission tunnel, exposing a removable panel at the rear bulkhead.
3. Undo six screws and remove this panel. The slave cylinder may now be seen, on the upper side of the bell housing.
4. Drain off the clutch hydraulic fluid via the bleed nipple.
5. Remove the flexible hydraulic pipe line from the slave cylinder.
6. Remove the two slave cylinder bolts, ensuring that the push rod, which will become loose, does not fall out into the bell-housing.
7. Withdraw the slave-cylinder from the bell housing.

Re-assemble in reverse sequence, and bleed the system in the conventional manner. No re-adjustment of the slave cylinder pushrod length should be required, unless the clutch assembly itself has been changed.

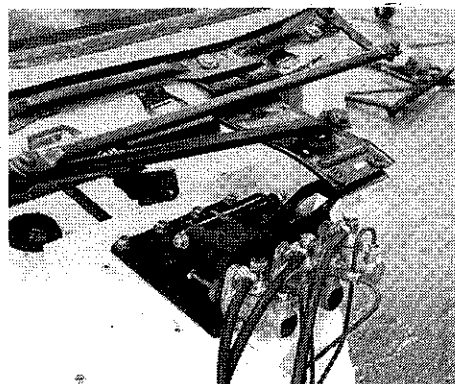
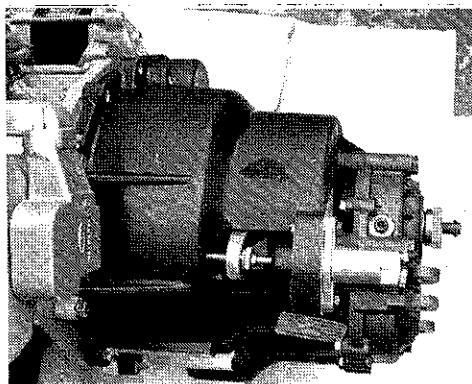

Clutch master cylinder position

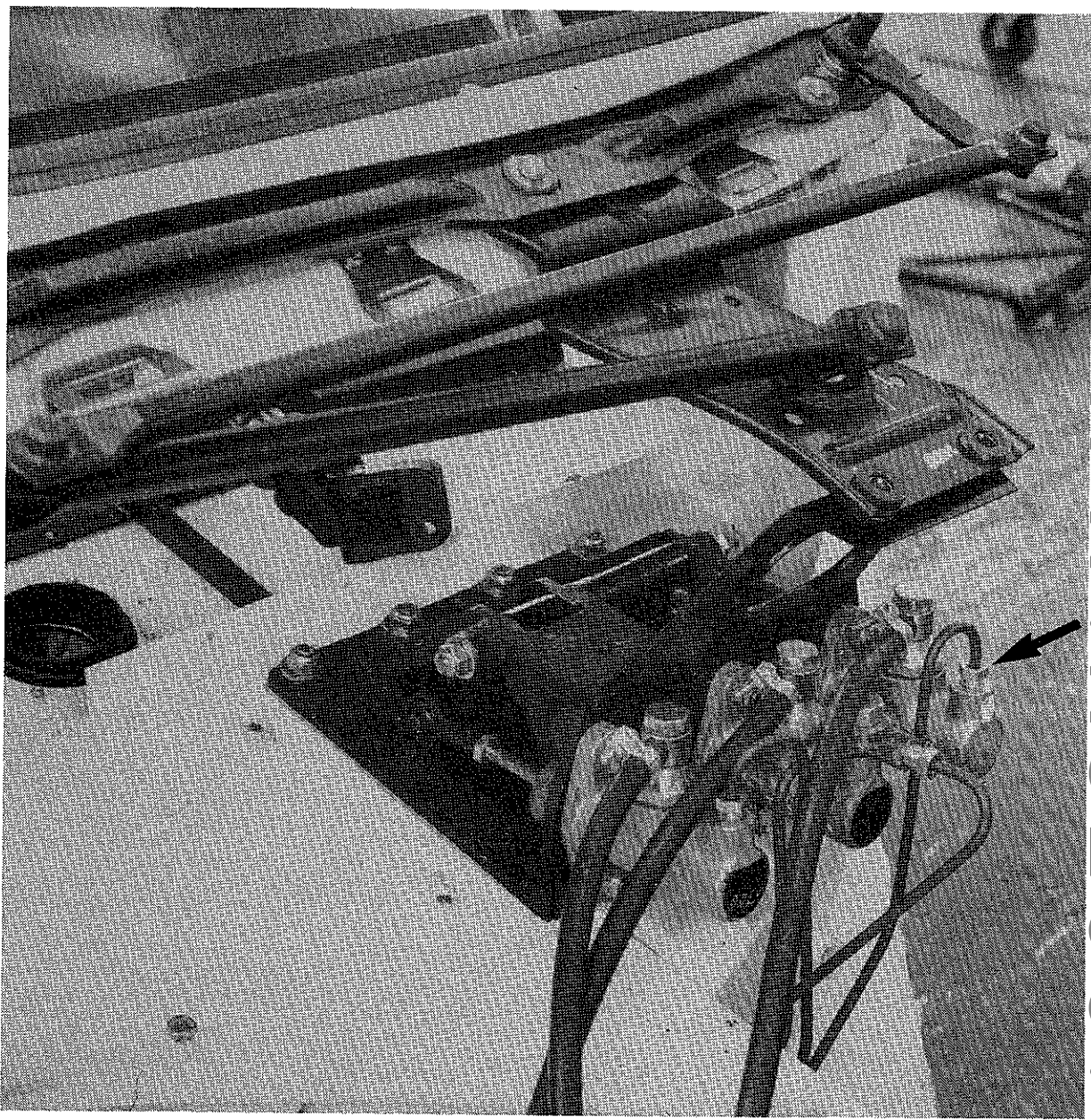

WWW.RS200.ORG

Transfer gearbox

This component is mounted ahead of the clutch bell-housing, and is connected to the main transmission casing by the primary propeller shaft. It has two functions. One is to realign the drive between the engine (which is offset towards the left of the structure) and the transmission. The other is to provide a slight step down ratio between the engine, and the primary propeller shaft.

[For competition purposes, an alternative set of transfer gear ratios would change the overall gearing of the car - and this could not quickly be achieved in any other way].

Removal

1. Remove the left side passenger seat - four bolts to the floor panel.
2. Peel back the carpet from the transmission tunnel, exposing a removable panel at the rear bulkhead.
3. Undo six screws, and remove this panel.
4. Through the exposed access hole, remove the locknut from the clutch spigot shaft.
5. Depress the clutch pedal, and withdraw the spigot shaft.
6. Disconnect the primary propeller shaft, by undoing the four bolt fixings. Removal of the shaft, however, is not necessary.
7. Remove the outer flange stub from the transfer box
8. Disconnect the oil feed and return pipes from the transfer box casing.
9. Undo four bolts fixing the transfer box to the bell housing.
10. Withdraw the transfer box housing from the clutch bell housing, forward through the access panel hole, into the car's interior. [Note: There are two locating dowels.]

Re-assemble in the reverse order.

Do not run the engine when the lubricant in the Transfer Gearbox has been drained. Do not run the engine until the transmission assembly has also been installed, its oil pipes connected up to the Transfer Box, and the correct amount of Transmission Fluid has been added.

Failure to take this precaution will quickly lead to the failure of the oil seals in the Transfer Box, and to the Transfer gears themselves.

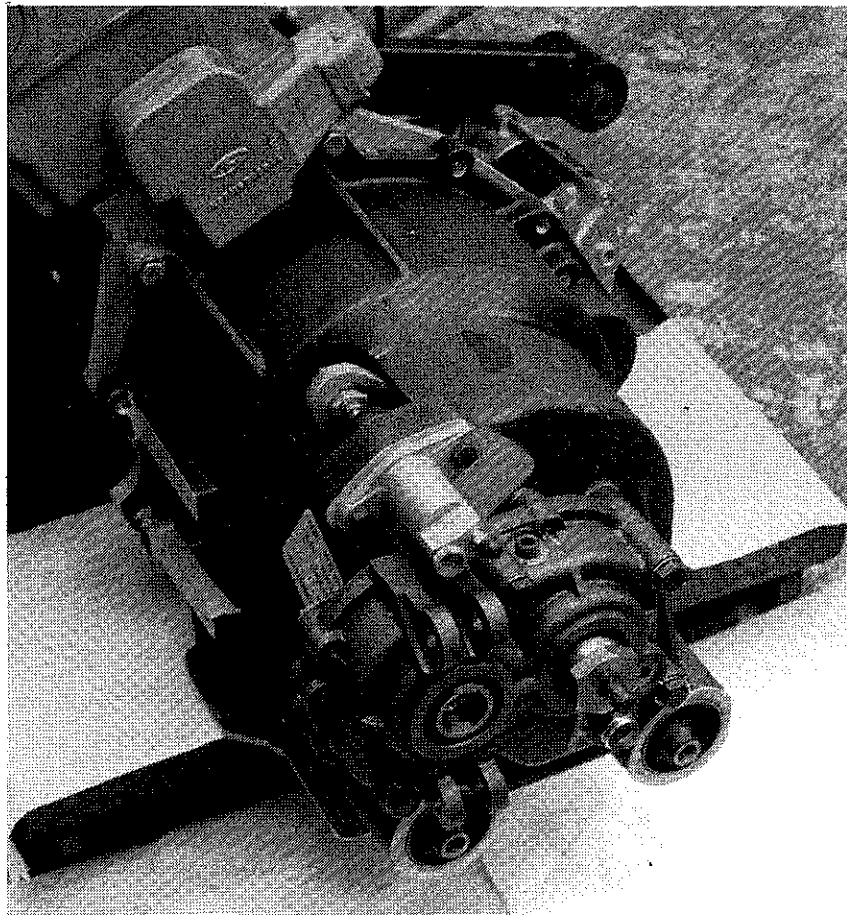

Upgrading for serious motor sport

See *Optional Ford Motorsport Parts* section, for details of alternative ratio kits.

Lubrication

Coat the gears with transmission oil before assembling them to the car. Re-check the transaxle oil level, with the dipstick provided, after the transfer gears have been assembled, the oil lines connected up, and the first short test run has been made. Top up the transaxle oil level, if necessary.

Primary Propeller Shaft

This links the engine/clutch/transfer gear casing assembly, to the main transaxle.

Removal

Note: Access to this component is from inside, and also underneath, the car.

1. Remove the left-side seat, and the access panel, as detailed under 'Clutch'.
2. Disconnect the rear of the propeller shaft from the transfer gear flange, by undoing four bolt fixings.
3. From underneath the car, remove the two chassis safety straps spanning the transmission tunnel (two nuts per strap), which allows the propeller shaft to be lowered.
4. Lower the rear end of the shaft, clear of the body/chassis unit, then gently remove it, rearwards, by extracting the front end of the shaft from the transmission casing.

Re-assemble in reverse order, checking that no damage is done to the transmission casing, or the splines, when the shaft is being re-inserted.

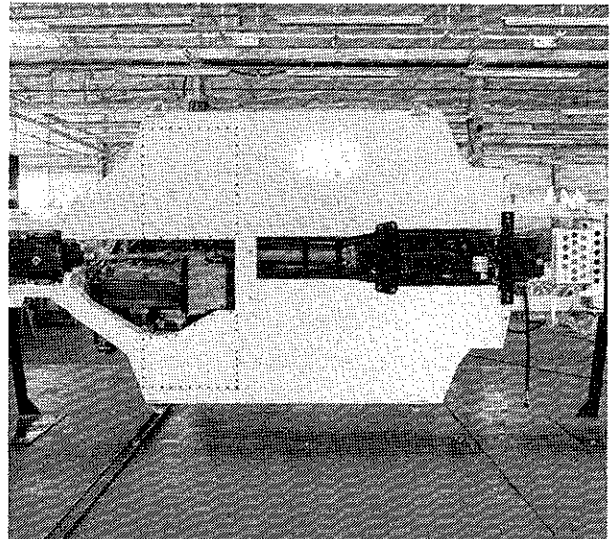
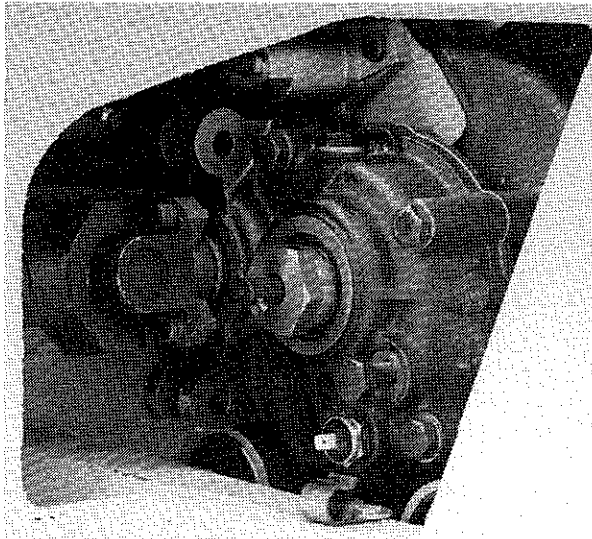

Transmission assembly

The transmission of the RS200 is concentrated inside magnesium alloy casings, mounted at the front of the car. Inside the casing are, respectively, a five-speed, all-indirect, all-synchromesh gearbox, a two-wheel-drive/four-wheel-drive/locked centre differential control, the centre differential which splits the drive between front and rear wheels, and the front differential itself.

Both the differentials have viscous coupling limited-slip mechanisms. The casing is connected to the engine/clutch/transfer gears by a primary propeller shaft, and is connected to the rear differential by a secondary propeller shaft.

On Rally vehicles there are two separate gear-change, or transmission-change linkages, leading to two levers in the cockpit, located on the transmission tunnel. One linkage controls gear changing, in a conventional manner. The other linkage controls the choice of drive mode. The second linkage is not fitted to road cars.

Although this assembly comprises five separate castings, bolted end to end, it is intended that the transmission should always be removed from the body/chassis unit in one piece.

The transmission was designed, and manufactured, for FORD, by FF Developments Ltd., of Coventry.

Removal

1. Jack up the car, and place on stands. It is not necessary to remove the road wheels.
2. Withdraw the gaiters from the inner end of the front drive shafts. This exposes the fixings of the shafts to the front differential.
3. Remove the six fixing bolts from each shaft/differential connection.
4. Disconnect all oil feed pipes from the transmission casing to the front oil cooler and transfer box.
5. Remove both gear lever knobs, and the gaiters over the knobs to the transmission tunnel and the reverse lamp switch wiring.
6. Remove the two chassis safety straps spanning the transmission tunnel (two nuts per strap), which allows the propeller shafts to be lowered.
7. Support the transmission assembly on a trolley jack before proceeding any further.
8. Disconnect the transmission casing front and rear cross-members from the underside of the body/chassis unit - two bolts per side, per cross-member.
10. Using the trolley jack, and with manual assistance, gently lower the transmission casing free of the car, clearing the gear levers and change mechanism from the transmission tunnel, then ease it gently forward, to release both propeller shafts from the rear of the casing.

Do not run the engine at any time when the transmission assembly lubricant has been drained, and when supplies to the Transfer Box have been interrupted.

Failure to take this precaution will quickly lead to the failure of the oil seals in the Transfer Box, and to the Transfer gears themselves.

Re-assemble in the reverse order, ensuring that the front drive shafts are dirt free and lightly oiled before they are re-inserted. Refill, if necessary, the transmission casing, allow a few minutes for the level to settle, and re-check it before driving the car again.

Transmission installation

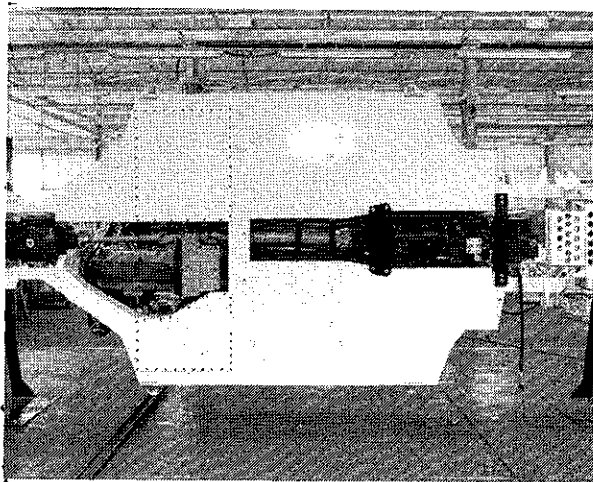

Transmission assembly

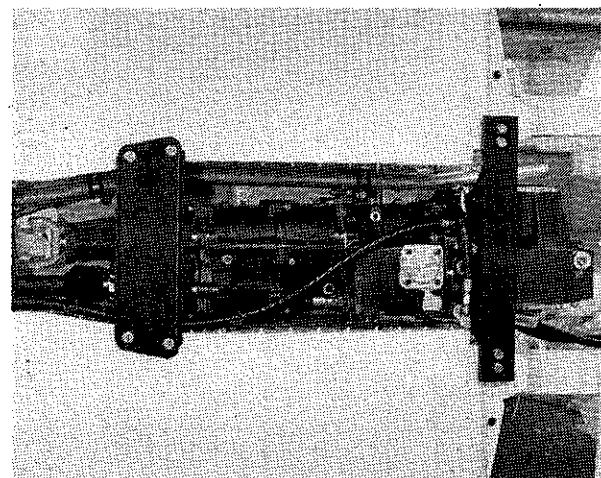

Partial strip down of transmission assembly

Having removed the main transmission assembly, complete, from the car, this may be split into its three main sub-sections - main gearbox and two-wheel-drive/four-wheel-drive control, centre differential, and front final drive units.

With the complete casing on a workbench, proceed as follows:

1. To separate the front final drive casing from the assembly, remove the eight nuts from the securing studs, and gently ease the casing forwards. You will note that there are two dowels around the periphery of the casings.
2. Remove the rubber O-ring type of seal between the two faces. On re-assembly, a new O-ring seal should be used, and sealed into position by a Loctite flange sealant.
3. Check that the small O-rings surrounding the oil pick-up transfer passage, and the oil feed drillings in the front face of the centre differential casing have not been displaced.

Re-assemble in reverse sequence. When mating the two casings, it will be necessary to ensure that the splines of the oil pump drive shaft (protruding from the centre differential casing) re-engage correctly with the main drive, which is in the front final drive assembly. This can be done, with help, by slightly rotating a propeller shaft output flange at the rear of the assembly, or by using a slim screwdriver inserted between the two casing faces, to re-adjust the main drive gear position as appropriate.

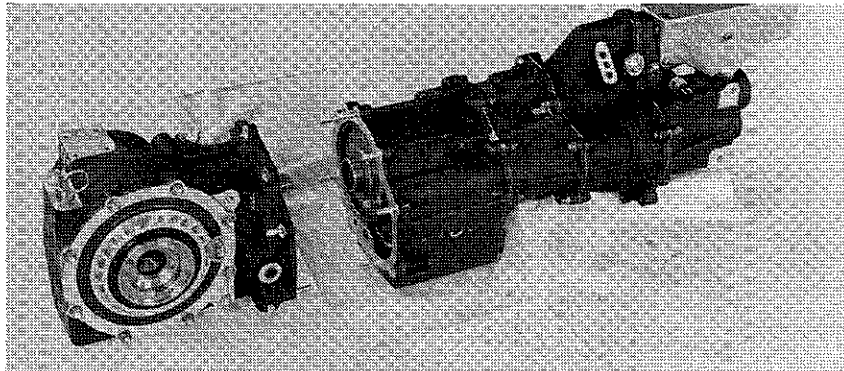

To strip the centre differential casing from the main gearbox casing:

4. Select the two wheel drive transmission mode. Disconnect the control rod from the two-wheel-drive/four-wheel-drive mode lever, at the centre diff, by removing one nut and bolt. It is not necessary to remove the rod completely.
5. Strip the centre differential casing, by removing seven nuts from their studs. Gently ease the centre diff casing forwards. You will note that there are two dowels around the periphery of the casings; it is possible that these may be a tight fitting.
6. When splitting the casings, ensure that the bronze thrust washers inside the two-wheel-drive/four-wheel-drive mode, do not become displaced.

Re-assemble in reverse sequence.

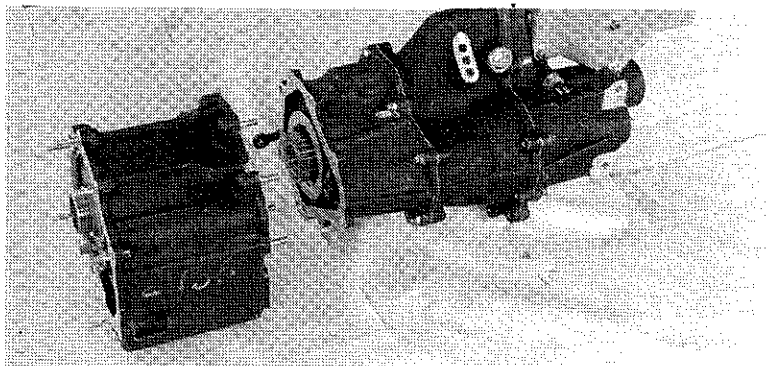

To remove the centre differential's Viscous Coupling (VC) unit:

This can be done when the centre differential casing and assembly has been separated from the main transmission and gearbox casings, as described above.

In the majority of cases, the VC may be removed merely by pulling it in the *forward* direction (relative to its installation in the car). If, however, this does not prove possible, proceed as follows:

7. Place the centre differential casing and assembly on a workbench, with its rear face upwards.
8. Remove the two-wheel-drive/four-wheel-drive selector indent (by taking out one grub screw), from the right underside of the casing, at the same time removing the ball and spring.
9. Pull the external 2WD/4WD selector lever upwards, to disconnect the internal selector from the 2WD/4WD mode.
At the same time, lift the 2WD/4WD mode upwards, out of the casing, ensuring that no gears, or thrust washers, become displaced.
10. Restore the casing to a horizontal position on the bench.
11. Using a suitable drift, now lightly tap the VC assembly *forwards* (relative to its installation in the car), to remove it from the casing.

On re-assembly, ensure that the copper thrust washer on the forward face of the annulus is in the correct position.

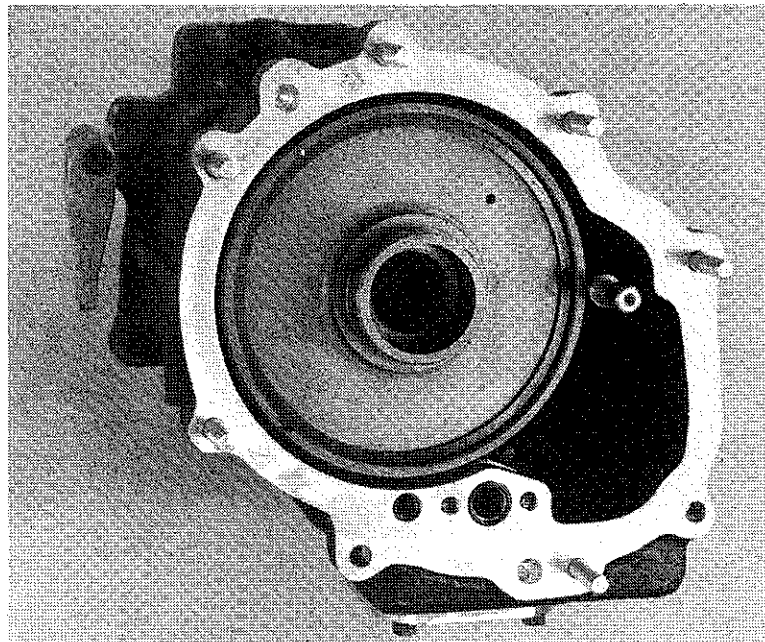

To remove the gear lever linkage from the gearbox casing

1. If this has not already been done, disconnect the 2WD/4WD mode control rod from the centre differential casing.
 2. Disconnect the rollpin *behind* the gaiter, freeing the remote control shaft from the selector shaft into the gearbox casing.
 3. Remove the two through nuts and bolts which secure the gear lever support housing to the casting.
 4. The linkage may now be removed.
- Re-assemble in reverse sequence.

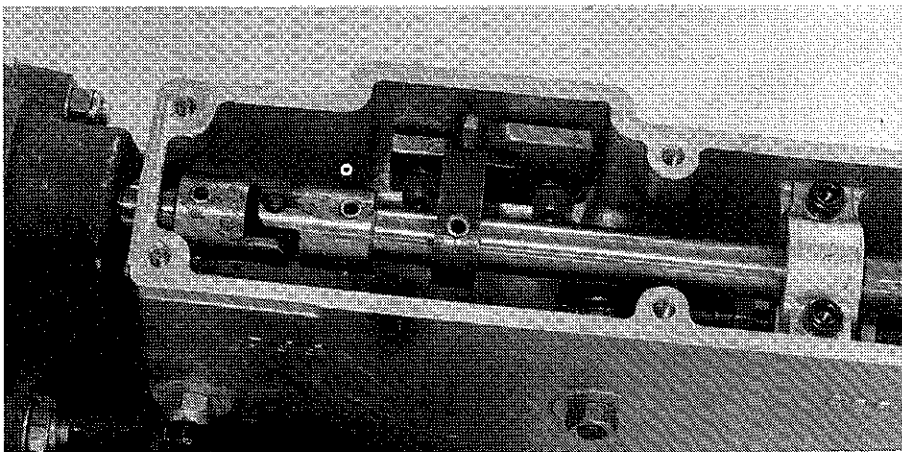
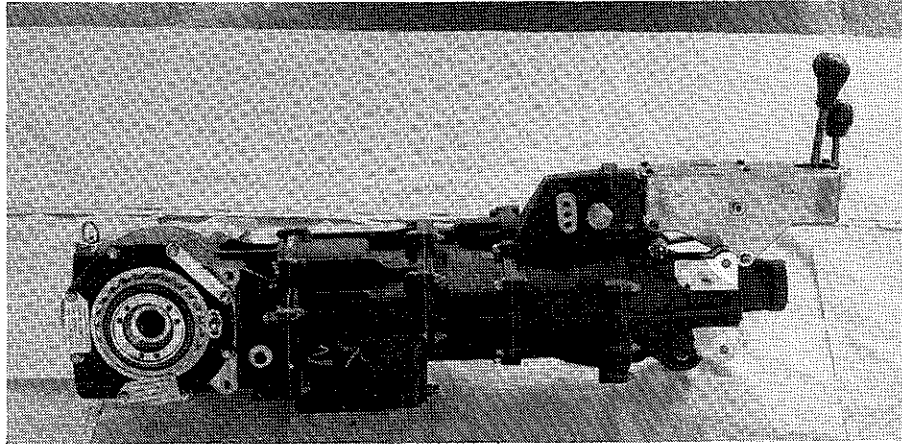

To change the oil seals surrounding the propeller shaft entry points:

1. Remove the plates from the end of the casing - three small Allen screws in each instance.
2. The oil seals are now laid bare, and may be replaced in the usual way.

To remove, and clean, the wire gauze oil filter in the centre diff case:

This may be done with the transmission installed in the car, or with the complete transmission on the workbench after removal from the car.

1. Remove four bolts which secure a plate to the bottom of the centre differential casing.
 2. Gently drop down the plate, on which sits a gauze filter.
 3. A rubber O-ring is used to seal the plate to the casing.
On re-assembly, ensure that this O-ring is properly located.
 4. Remove the gauze filter, and clean it thoroughly, before beginning re-assembly.
- Re-assemble in reverse sequence.

Transmission oil cooler

The transaxle of the RS200 contains the main gearbox, the two-wheel-drive/four-wheel-drive control, the centre and the front differentials, all of which share a common lubricant. Details of the frequency of transmission oil changing are given in the separate Service Plan booklet.

Because it is important that the transmission lubricant is kept at an optimum temperature, an air-to-oil cooling radiator is provided. This is mounted low down, at the front of the car (underneath, though not connected to, the water radiator), and is connected to the transmission casing by armoured piping which passes along the inside of the front chassis frame.

To remove the cooler

1. Access to the cooling radiator is from the front underside of the car, ideally when the car is standing over a pit. Alternatively, if it is not desired to drain every drop of the transmission lubricant from the system, the front of the car may be jacked up, and supported on axle stands.
2. Loosen and remove the four nuts and bolts securing the oil cooler support closing plate to the chassis frame and, while supporting the cooling radiator itself, withdraw the plate.
3. Gently withdraw the cooling radiator, downwards, from the rubber padding inside the chassis frame.
4. Disconnect the cooling radiator from the armoured pipes, and allow the transmission lubricant to drain away into a waste container.
5. Plug the ends of the armoured pipes, and also of the cooling radiator itself, to ensure that no dirt, or foreign matter, enters the system.

Re-assemble in reverse sequence. However, before beginning re-assembly, clean out the cooling radiator's external air passage, of dirt and other debris, clean around the housing in the chassis, and check that the rubber padding has not chafed away at any point; if chafing has taken place, repad that particular area.

Having completed re-assembly, do not forget to refill the transmission and, having done this, run the engine and check that there are no leaks at the joints.

Oil Cooler/Radiator installation

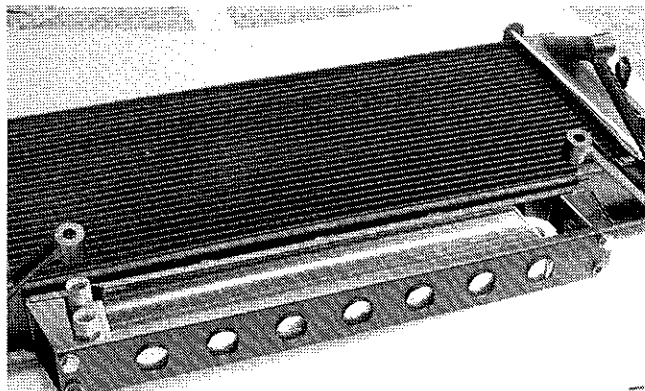
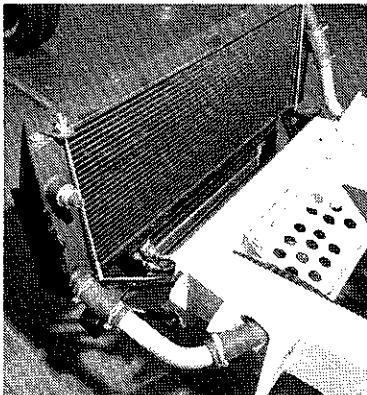

Propeller shaft - transmission casing to rear final drive

This is a three-piece sub-assembly, running down the centre of the car, connecting the main transmission casing, to the rear final drive. The centre section is supported in a bearing mounted on the side of the clutch bell housing.

Removal

1. Jack up the car, place it on stands, but do not remove the wheels.
2. Remove the four fixings from the flange connecting the shaft to the rear final drive unit.
3. Remove the four fixing screws connecting the centre bearing assembly to the clutch bell housing - this allows the centre bearing to be moved clear of the engine.
4. Remove the two chassis safety straps spanning the transmission tunnel (two nuts per strap), which allows the propeller shaft to be lowered.
5. Drop the rear of the shaft assembly below the level of the final drive, then withdraw the assembly rearwards, extracting the front of the shaft from the transmission casing.

Re-assemble in reverse order, checking that no damage is done to the transmission casing, or the splines, when the shaft is being re-inserted.

If the main propeller shaft rear section is separated at its centre splines, care must be taken to reassemble with the alignment marks adjacent. These are on the end of the shaft and the flange rear face.

Note: If necessary, this sub-assembly may be split, at a point ahead of the centre bearing, so that the front portion, or the rear portion, may be removed without disturbing the other half of the shaft.

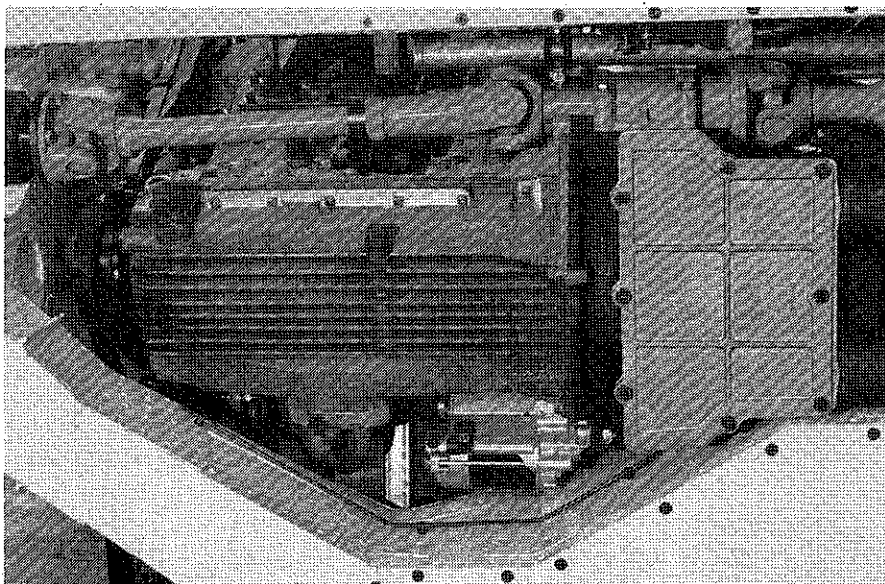
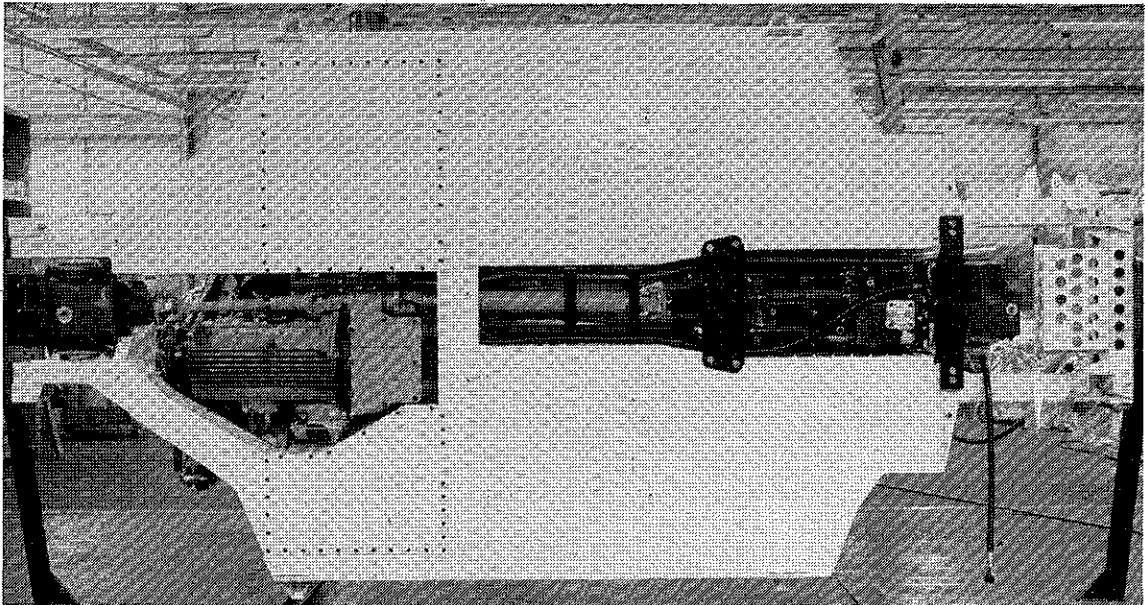

Rear axle assembly

This component is mounted behind the engine, to the body/chassis unit. It receives torque, via the rear propeller shaft, from the main transmission casing at the front of the car, and is linked to exposed drive shafts to each rear wheel. It has a magnesium alloy casing, and houses a viscous-drive limited-slip differential.

Removal

1. Jack up the rear of the car, and place the body/chassis unit on stands.
2. Remove the tubular chassis brace (two bolts) which is situated under the nose of the differential.
3. Disconnect the four fixings connecting the propeller shaft to the final drive mechanism.
4. Disconnect all the inner retaining fixings which connect the drive shafts to the differential unit.
5. Support the final drive assembly's weight on a trolley jack.
6. Remove the two front mounting nuts and bolts - one at each side - which are ahead of the line of the drive shafts.
7. Remove the two rear mounting bolts, which attach the differential casing to the transverse rear suspension plate.
8. Gently lower the differential out of the structure.

Re-assemble in the reverse order. Remember to check, and if necessary, top up, the level of the lubricant, before once again driving the car.

Side view

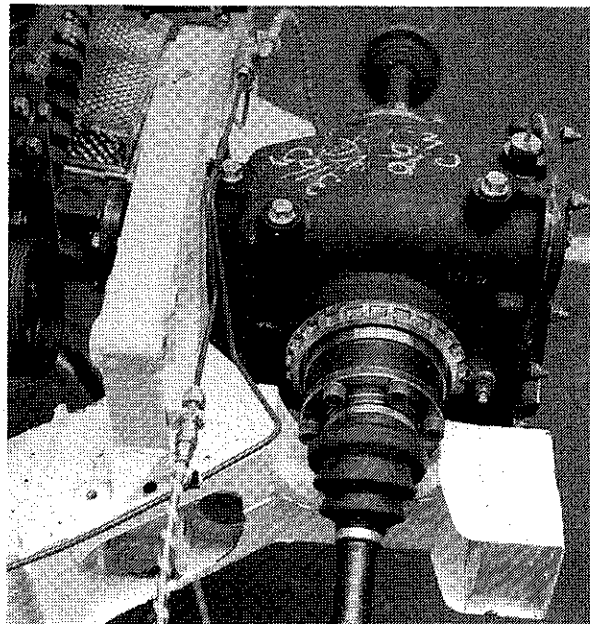

Front wheel drive shafts

The drive to the front wheels is taken from the transmission casing to the front wheel hubs by exposed drive shafts, which are universally jointed at each extremity.

When the transmission is in two-wheel-drive mode, the front wheels are not driven, and torque is not fed through these drive shafts.

For all normal road purposes, however, the RS200 should be used in four-wheel-drive, open-centre-differential mode.

Although no regular lubrication of these shafts is required, at every regular maintenance interval (More frequently, if the RS200 is to be used in conditions where flying stones might be encountered) the condition of the inner drive shaft gaiters should be inspected, in case of tears or rupture.

Removal

1. Jack up the front of the car, apply the handbrake, and remove the appropriate wheel.
 2. Remove the large (32mm) nut, which holds the outer end of the drive shaft into the suspension upright. This is exposed, in the centre of the brake disc, when the wheel is removed.
 3. Withdraw the gaiter from the inboard universal joint, to gain access to the six bolt fixings to the transmission casing final drive.
 4. Disconnect the six bolts connecting the shaft to the final drive unit.
 5. Drop down the inboard end of the drive shaft, then gently withdraw it from the suspension upright.
- Re-assemble in reverse order, taking especial care to relocate the gaiter properly, and to ensure that the 32mm nut is securely fastened at the shaft's outer end.

Note: The outer end of this drive shaft holds the wheel bearing and stud flange together. Damage will occur if the vehicle is supported by the wheel without the driveshaft outer joint being correctly fastened.

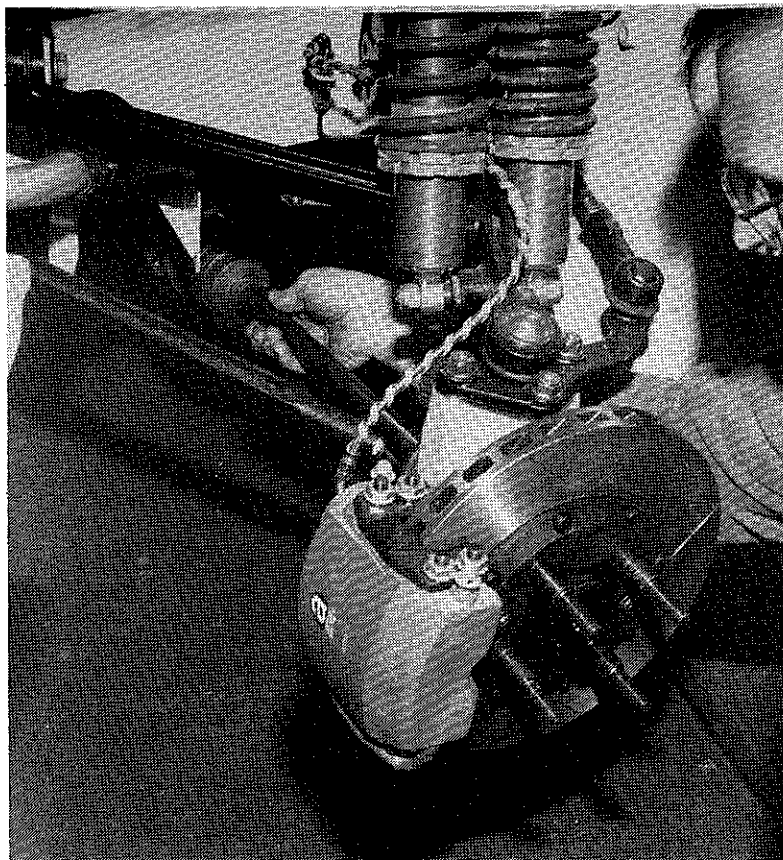

Rear wheel drive shaft

The drive to the rear wheels is taken from the rear differential casing, to the rear wheel hubs, by exposed drive shafts, which are universally jointed at each extremity.

Although no regular lubrication of these shafts is required, at every regular maintenance interval (More frequently, if the RS200 is to be used in conditions where flying stones might be encountered) the condition of the inner drive shaft gaiters should be inspected, in case of tears or rupture.

Removal

1. Jack up the rear of the car, chock the front wheels, and remove the appropriate rear wheel.
2. Remove all outer retaining bolts, fixing the drive shaft to the stub axle.
3. Remove the fixings from the drive shaft to the final drive.
4. The shaft may then be extracted from the car, by dropping it downwards.

Re-assemble in reverse order. Ensure that both universal joints are correctly pre-packed with lubricant before completing re-assembly.

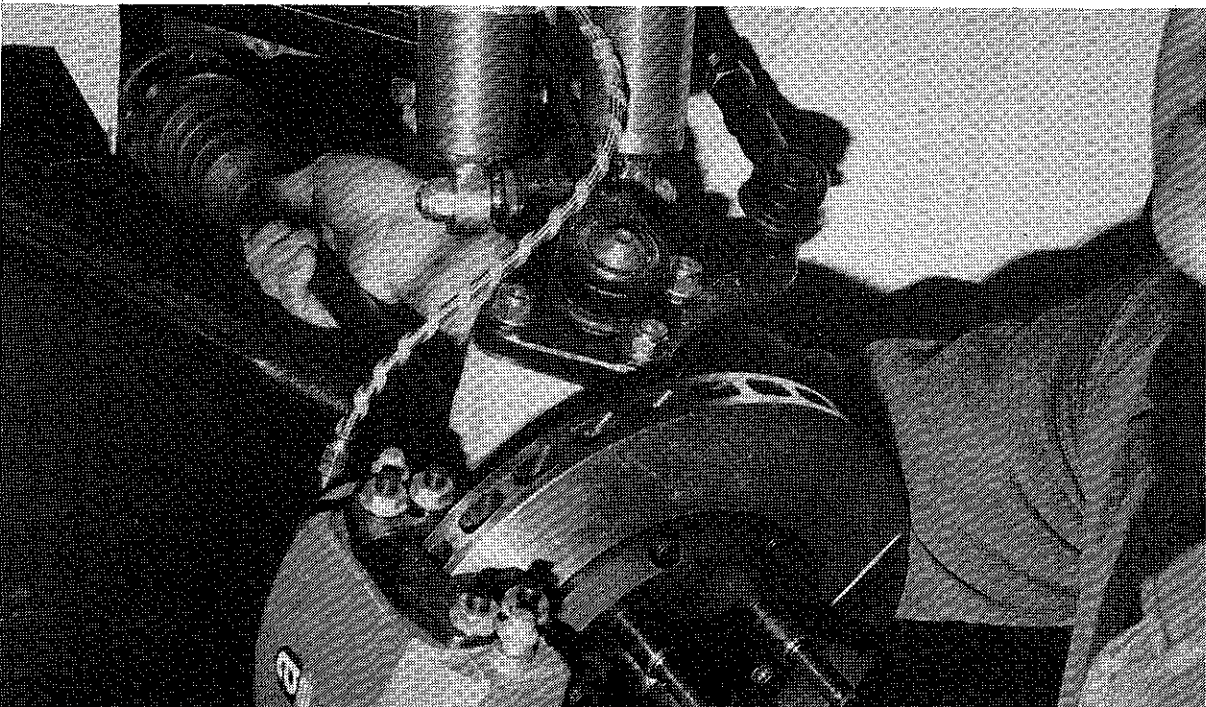
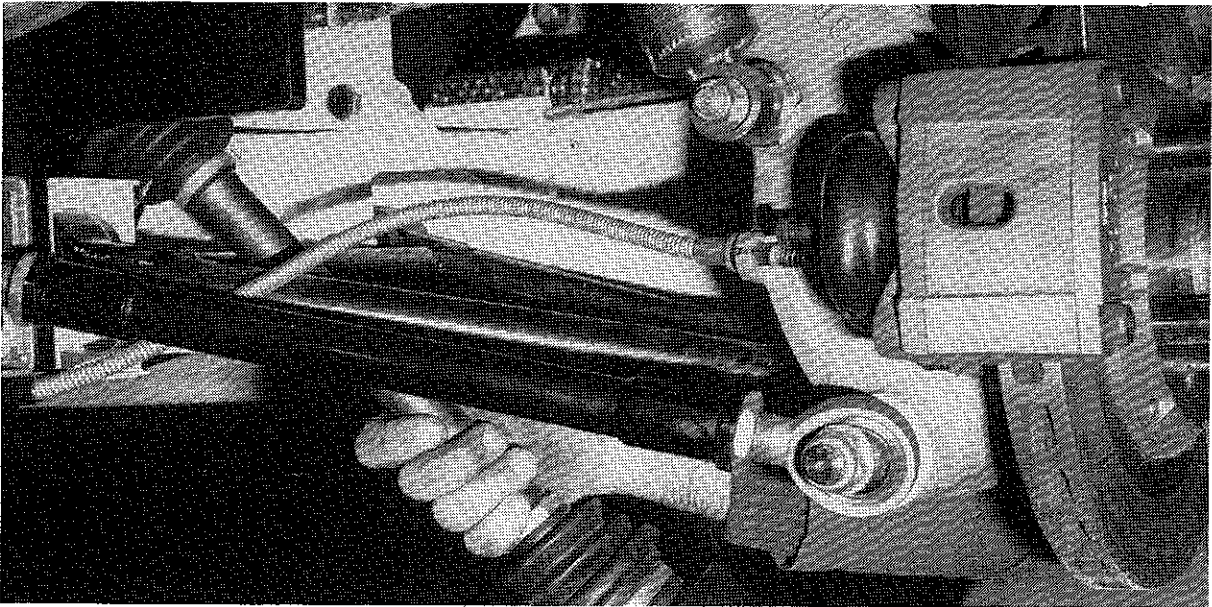

FRONT SUSPENSION

Index

	Page Nos.
Castor adjustment	42
Ride height adjustment	43
Coil spring/damper units	46
Wishbone bushes	48-49
Front suspension, top ball joint	49
Front suspension, bottom ball joint	50
Hub bearing	51
Anti-roll bar	52

WWW.RS200.ORG

Adjusting the castor

The castor angle (the angle between the line joining ball joint pivots of the upper and lower wishbones, and the vertical), may be adjusted, if necessary, by altering the length of the forward member of the lower wishbone assembly.

Note that any alteration of this castor setting will also have a marginal effect on the static camber setting. The nominal settings for the RS200 are:

Wheel Camber	1½ degrees negative (the top of the tyre leans slightly inwards towards the centre of the car)
Castor	2½ degrees positive (the bottom ball joint is slightly further forward than the upper ball joint). Subject to bump steer adjustment.

To adjust the castor:

1. Set up the front wheels on steering turntables, and ensure that the suspension is at its normal, unladen, setting.
2. Loosen the locknut on the forward member, close to the suspension upright.
3. Loosen and remove the fixing between the forward member, and the lower wishbone track control arm. This allows the screwed section to be raised clear of the track control arm, and be operated.
4. To increase the castor, screw in the adjuster by the desired number of half-turns; to decrease the castor, screw it out. The castor is increased by shortening the effective length of the forward member, decreased by lengthening it. Each half turn produces a castor change, around the nominal position of 20 minutes of arc.
5. Re-lock the locknut in the lower member, when the desired setting is reached.
6. Re-check the setting once re-assembly is complete.
7. Finally, recheck the toe-in and toe-out figure, re-setting if necessary. Standard setting is zero toe.

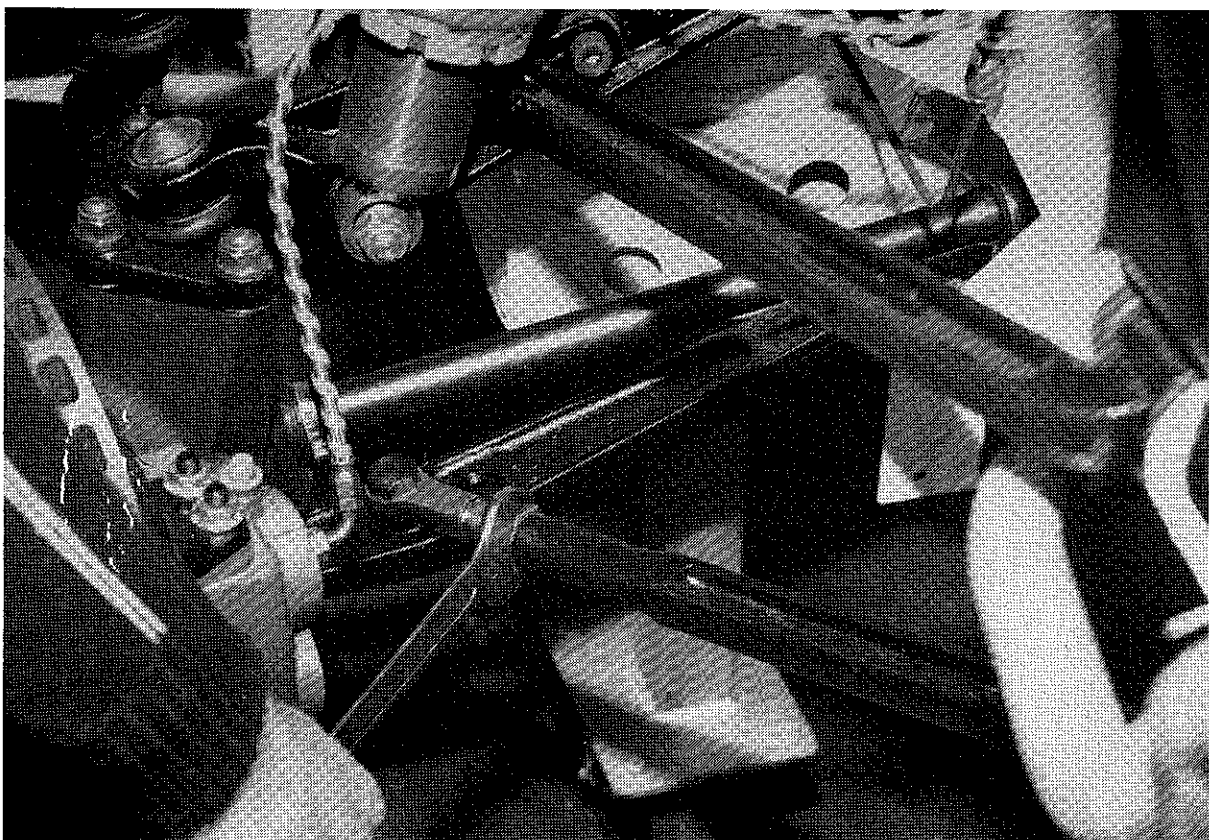

Front suspension ride height adjustment

⚠ WARNING—This short section should be read in conjunction with the similar section concerning the rear suspension. A change to the front suspension ride height should only be carried out at the same time as a similar change to the rear suspension ride height.

It is not recommended, for instance, that the RS200 should be used with the front suspension ride height set for maximum ground clearance, and the rear suspension ride height for minimum ground clearance.

The standard RS200 is built, and delivered to its owner, with the suspension geometry optimised for normal driving on surfaced roads. In this condition, the inner (chassis) mountings of the suspension wishbones are in the *uppermost* of the alternative pivot positions. The ride height is 180 mm sill to ground at kerb weight.

If extra ground clearance is required, where the RS200 is to be driven habitually over rough surfaces, the chassis structure must be raised, relative to the wheels, and the suspension links. To do this, the inner (chassis) mounting of the upper and lower wishbones have to be moved to the *lowermost* of the alternative pivot positions. "Off road" top wishbones **MUST BE USED** if this change is made.

DO NOT make this change to the upper wishbones, without also making it to the lower wishbones at the same time, or the carefully evolved suspension geometry, and the steering capabilities of the RS200, will be adversely affected.

If you carry out this modification, check right round the front suspension - a total of four inner pivots are involved at each side of the car - before driving the car again. In addition, check, and if necessary, re-adjust the camber, castor, and toe-in of the suspension.

The difference between 'normal', and 'raised' ground clearance, at the front of the car, is approximately 30 mm/1.2 in., adjusted at the spring seats.

In addition, when making the suspension height change, it is necessary to fit a pair of modified steering arms.

Bump steer check/adjust (After check/adjust of camber, castor and ride height).

Support vehicle on jack, disconnect front damper units. Lower vehicle to ride height and check toe setting is parallel.

Further lower vehicle to ride height and check toe setting is parallel. Further lower vehicle by 60 mm at which point toe out setting should be between 12 mm and 36 mm total for both wheels. If toe out is less than 12 mm castor angle should be reduced on both sides until correct measurement is achieved by adjusting length of front lower foremost wishbone arms. If toe out is greater than 36 mm castor angle should be increased.

WWW.RS200.ORG

Suspension

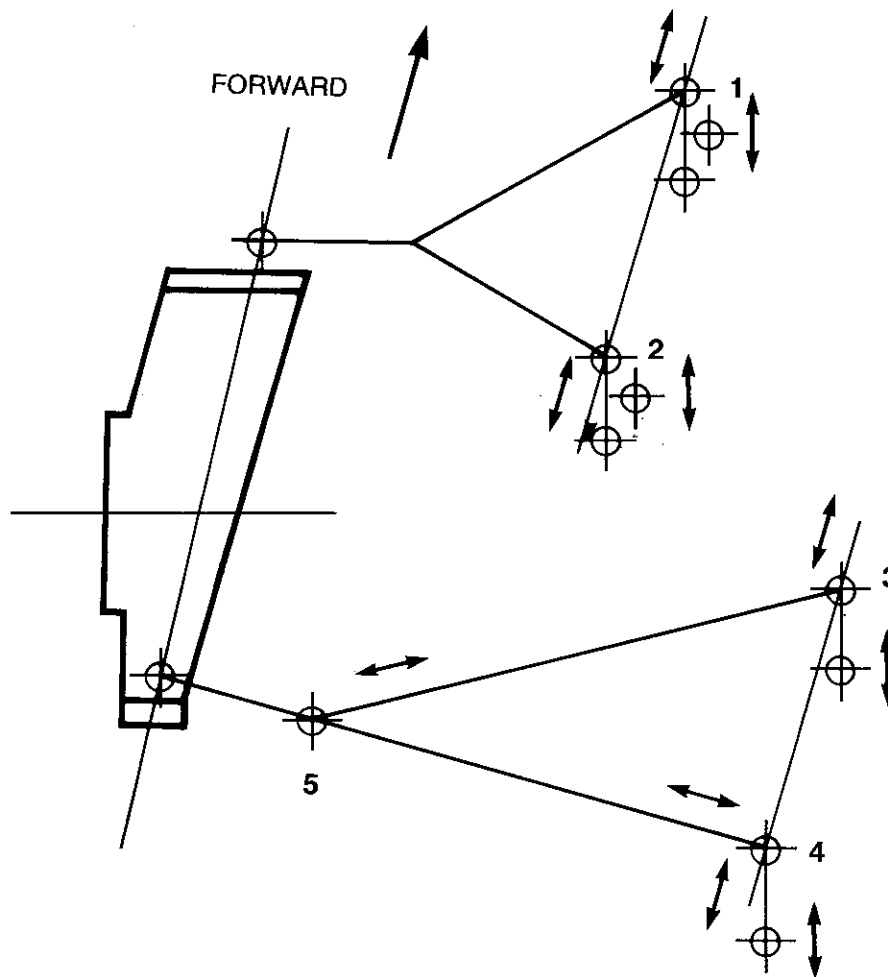

Point **1 2** ride height adj.
and castor adj.

Point **3 4** ride height adj.
and castor adj.

Point **4** camber adj.

Point **5** castor adj. and
fine camber adj.

FRONT SUSPENSION ADJUSTMENTS

NB. Ride height adjustment may only be carried out with ½ tank of fuel and the weight of two people eg. 85 kilo per seat

WWW.RS200.ORG

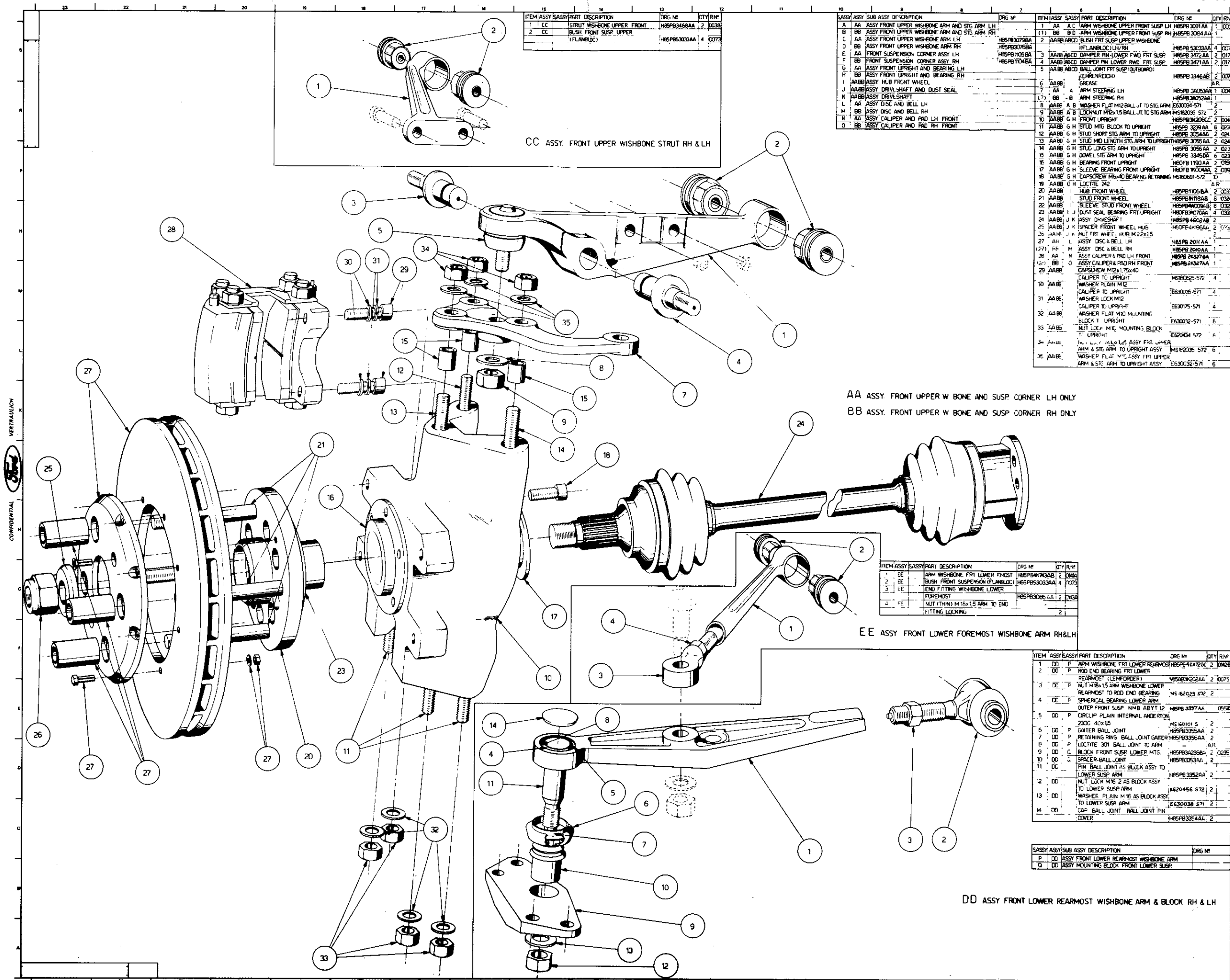

ITEM	ASSY	SASSY	PART DESCRIPTION	DRG NO	QTY	R/NP
1	CC		STRUT WISHBONE UPPER FRONT	H85PB3468AA	2	0038
2	CC		BUSH FRONT SUSP UPPER (FLANBDC)	H85PB3030AA	4	0073

CC ASSY FRONT UPPER WISHBONE STRUT RH & LH

ITEM	ASSY	SASSY	PART DESCRIPTION	DRG NO	QTY	R/NP
A	AA	A	ASSY FRONT UPPER WISHBONE ARM AND STG ARM LH	H85PB3031AA	1	0038
B	BB	B	ASSY FRONT UPPER WISHBONE ARM AND STG ARM RH	H85PB3032AA	1	0038
C	AA	ABC	ASSY FRONT UPPER WISHBONE ARM LH	H85PB3079BA	2	0077
D	BB	ABC	ASSY FRONT UPPER WISHBONE ARM RH	H85PB3079BA	2	0077
E	AA		FRONT SUSPENSION CORNER ASSY LH	H85PB1105BA	2	0176
F	BB		FRONT SUSPENSION CORNER ASSY RH	H85PB1105BA	2	0177
G	AA	ABC	ASSY FRONT UPRIGHT AND BEARING LH	H85PB3467AA	2	0077
H	BB	ABC	ASSY FRONT UPRIGHT AND BEARING RH	H85PB3467AA	2	0077
I	AA	BB	ASSY HUB FRONT WHEEL	H85PB3466AB	2	0074
J	AA	BB	ASSY DRIVE SHAFT AND DUST SEAL	H85PB3405AA	1	AR
K	AA	B	ASSY STEERING LH	H85PB3405AA	1	0040
L	AA	B	ASSY STEERING RH	H85PB3405AA	1	0040
M	AA	B	ASSY DISC AND BELL LH	H85PB3405AA	1	0040
N	BB	B	ASSY DISC AND BELL RH	H85PB3405AA	1	0040
O	AA	B	ASSY CALIPER AND PAD LH FRONT	H85PB3405AA	1	0040
P	BB	B	ASSY CALIPER AND PAD RH FRONT	H85PB3405AA	1	0040

AA ASSY FRONT UPPER W BONE AND SUSP CORNER LH ONLY
BB ASSY FRONT UPPER W BONE AND SUSP CORNER RH ONLY

ITEM	ASSY	SASSY	PART DESCRIPTION	DRG NO	QTY	R/NP
1	EE		ARM WISHBONE FRT LOWER FOREMOST	H85PB4030AB	2	0069
2	EE		BUSH FRONT SUSPENSION (FLANBDC)	H85PB3030AA	4	0073
3	EE		END FITTING WISHBONE LOWER	H85PB3036AA	2	0034
4	FE		NUT (THIN) M16x1.5 ARM TO END FITTING LOCKING		2	

EE ASSY FRONT LOWER FOREMOST WISHBONE ARM RH&LH

ITEM	ASSY	SASSY	PART DESCRIPTION	DRG NO	QTY	R/NP
1	DD	P	ARM WISHBONE FRT LOWER REARMOST	H85PB4142AC	2	0068
2	DD	P	ROD END BEARING FRT LOWER REARMOST (LEMFORDEP)	H85PB3022AA	2	0075
3	DD	P	MUT (THIN) M16 WISHBONE LOWER REARMOST TO ROD END BEARING	H85PB3022AA	2	0075
4	DD	P	SPHERICAL BEARING LOWER ARM OUTER FRONT SUSP NMB 45YT12	H85PB3397AA	0558	
5	DD	P	CIRCLIP PLAIN INTERNAL ANDERTON 2300 40x15	H85PB3397AA	2	
6	DD	P	GATER BALL JOINT	H85PB3395AA	2	
7	DD	P	RETAINING RING BALL JOINT GATER	H85PB3395AA	2	
8	DD	P	LOCITITE 301 BALL JOINT TO ARM		AR	
9	DD	Q	BLOCK FRONT SUSP LOWER MTG	H85PB3423BA	2	0236
10	DD	Q	SPACER-BALL JOINT	H85PB3053AA	2	
11	DD	Q	PIN BALL JOINT AS BLOCK ASSY TO LOWER SUSP ARM	H85PB3392AA	2	
12	DD	Q	MUT LUX M16 2 AS BLOCK ASSY TO LOWER SUSP ARM	H85PB3392AA	2	
13	DD	Q	WASHER PLAIN M16 AS BLOCK ASSY TO LOWER SUSP ARM	H85PB3392AA	2	
14	DD	Q	CAP BALL JOINT BALL JOINT PIN COVER	H85PB3394AA	2	

DD ASSY FRONT LOWER REARMOST WISHBONE ARM & BLOCK RH & LH

CONFIDENTIAL

WWW.RS200.ORG

Front suspension coil spring/damper units

Two combined coil spring damper units are fitted, to control the movement of each front suspension wishbone system. These incorporate adjustable height spring platforms, which allow the ground clearance of the car to be raised, or lowered, for competitions purposes. Bump rubbers are incorporated inside the coil springs, at the head of the damper spindles.

One spring/damper unit is mounted ahead of the main top wishbone forging, and one behind it.

To equalise the load on each coil spring, it is essential that the spring platform heights should be equal. A visual inspection will quickly confirm that this is so.

Removal of a spring/damper unit

1. Jack up the front of the car, support the chassis on stands, and remove the appropriate wheel.
Removing the load from the wheel also removes the load on the spring damper units.
 2. Remove the top pivot bolt.
 3. Remove the bottom pivot nut.
 4. The spring/damper unit may now be removed from the vehicle.
- Re-assemble in reverse sequence.

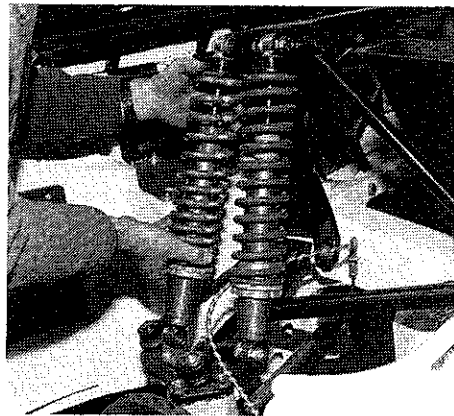

Separating a spring from the damper unit.

It is not necessary to remove the damper from the top wishbone for the spring to be removed.

1. Jack up the car, support the chassis, and remove a wheel - as above.
2. Remove the top pivot bolt of the spring/damper unit, and swing the unit clear of the mounting position.
3. Smartly tap down on the upper spring seat to loosen it from the top pivot, and slide the bump stop down the spindle.
4. Slightly depress the top of the spring; this allows the upper spring seat to be removed sideways (using the slot in the seat to clear the damper spindle).
5. Withdraw the spring upwards.

Re-assemble in reverse sequence, making sure that the spring seat lodges correctly in the top pivot before the spring takes up its own position against the seat.

Removal/changing a bump rubber

Proceed as for removing the coil spring, and remove the coil spring. Then:

1. Loosen the locknut on the damper spindle - this is immediately below the top pivot.
2. Completely remove the top pivot and the loosened lock nut.
3. Remove the old bump rubber.

Re-assemble in reverse sequence. (Correct torque necessary. Use Loctite.)

Adjusting the spring platform height:

The lower coil spring platform consists of two platforms, threaded to the damper body, and 'lock-nutted' together.

The platform height is set at the optimum level for normal road use. It is not recommended that the height is varied unless the owner needs to raise or lower the car for competition purposes.

Using an adjustable 'C' spanner, or simple special tool, the height of the platforms may be adjusted:

1. Jack up the car, support the chassis on stands, and remove the appropriate wheel.
2. Loosen off the locked-together spring platforms, adjust them up or down as required, then lock them up in the desired position.

Note: Before and after carrying out this operation, make sure that no dirt or debris remains in the fine threads of the damper body.

As the car is lowered on to its wheels, check that the coil springs are still seating properly on the platforms, and that the adjacent platforms are at the same height relative to each other.

Roll the car one complete turn of the wheels before a final check measurement is made.

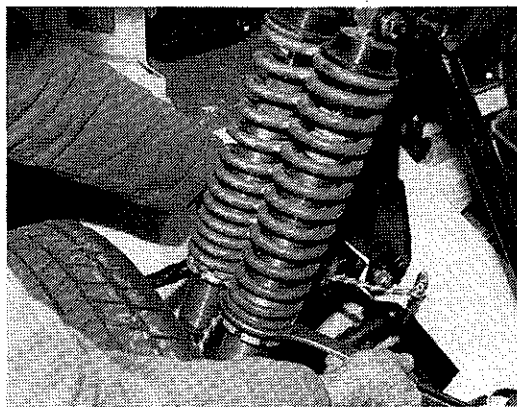

Wishbone bushes in the front suspension

All bushes in the front suspension are of the sealed for life variety, and regular maintenance is not required. At scheduled service intervals, however, the bushes should carefully be inspected for wear.

Removal of bush at inner end of lower track control arm

Before beginning this operation, accurately determine the length of the track control arm, between the centre line of the pivot bush and the ball joint centre line.

1. Jack up the car, rest the chassis on stands, and remove the appropriate wheel.
2. Loosen off the track control arm length adjusting lock nut but do not remove it.
3. Disconnect the anti-roll bar drop link from the track control arm.
4. Disconnect the forward member of the lower wishbone assembly, by undoing one bolt.
5. Remove the pivot bolt at the inner end of the track control arm.
6. Pull on the bottom of the upright, to allow the track control arm inner joint to clear the chassis bracket.
7. Remove the old joint.

Re-assemble in reverse sequence.

Note: After assembly, check that the effective track control arm length is the same as before, check and if necessary re-set the wheel camber before driving the car away.

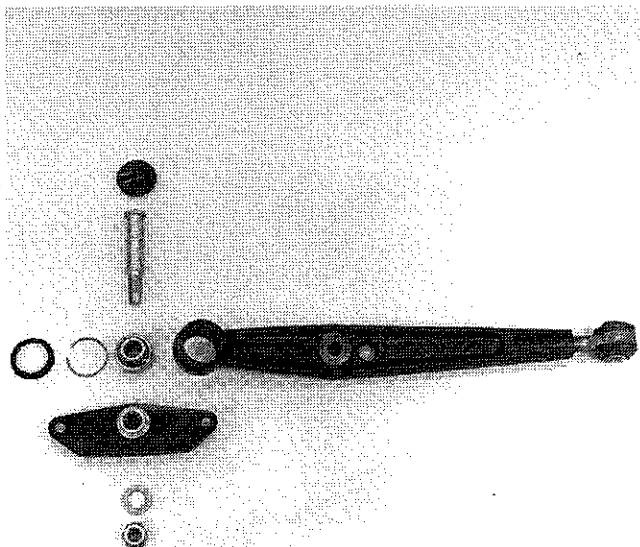
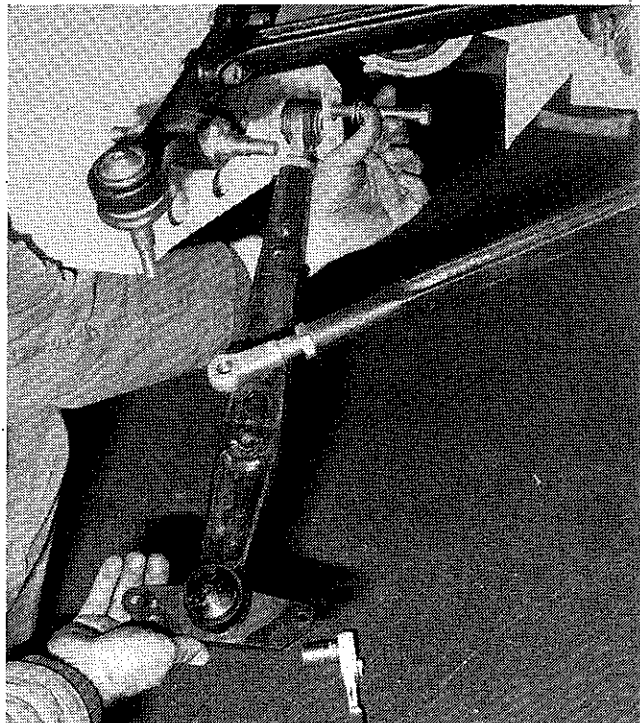

Removal of bush at inner end of forward member of lower wishbone assembly

1. It is not necessary to jack up, or to remove a wheel, to complete this operation.
2. Disconnect the forward member's connection to the main track control arm - one bolt.
3. Remove the inner pivot bolt linking the forward member to the chassis bracket.
4. The forward member may now be removed from the car, and the two piece rubber bush may be changed on the bench.

Re-assemble in reverse sequence. After re-assembly, check that the car's castor setting (which is governed by the length of this member) has not been disturbed, and re-adjust if necessary.

Removal of bushes at the inner end of the upper wishbone assembly

1. Jack up the car, support the chassis on stands, and remove the appropriate wheel.
2. Remove both the coil spring/damper units, to allow full access to the upper wishbone.
3. Remove the three nuts holding the upper ball joint and steering arm to the suspension to allow the assembly to be free of the upright.
4. Remove both the inner pivot bolts linking the wishbone to the chassis and pull the link clear of the brackets.
5. The two piece rubber bushes may now be extracted, and new bushes put in place.

Re-assemble in reverse sequence.

Front suspension, top ball joint

This is a sealed-for-life unit, and needs no normal maintenance. However, at some stage, it may become necessary to change the ball joint, especially if the RS200 has habitually been driven hard on unsurfaced or rocky roads.

To remove

1. Jack up the front of the car, rest the chassis frame on stands, and remove the appropriate wheel.
2. Loosen the ball joint securing nut, which is found inside the front wheel upright casting.
3. Insert a slim metal spacer between the upright casting, and the bottom of the ball joint screw thread.
4. Now, wind the ball joint securing nut progressively down, so that the adhesion of the ball joint taper is broken.
5. Loosen and remove the suspension spring damper units from their pivot on the top wishbone, swing them clear, and restrain them from moving back into alignment.
6. Remove the two bolts which form the chassis pivots for the upper wishbone.
7. Remove the top wishbone to the workbench.
8. Carefully grind away the weld which secures the ball joint to the wishbone forging.
9. Press out the ball joint housing, noting the correct alignment of the key slots, which ensure suitable articulation of the ball joint, in service.

Re-assemble in reverse sequence, checking once again that the key slots are correctly aligned.

TOP BALL JOINT ILLUSTRATION/PHOTOGRAPH

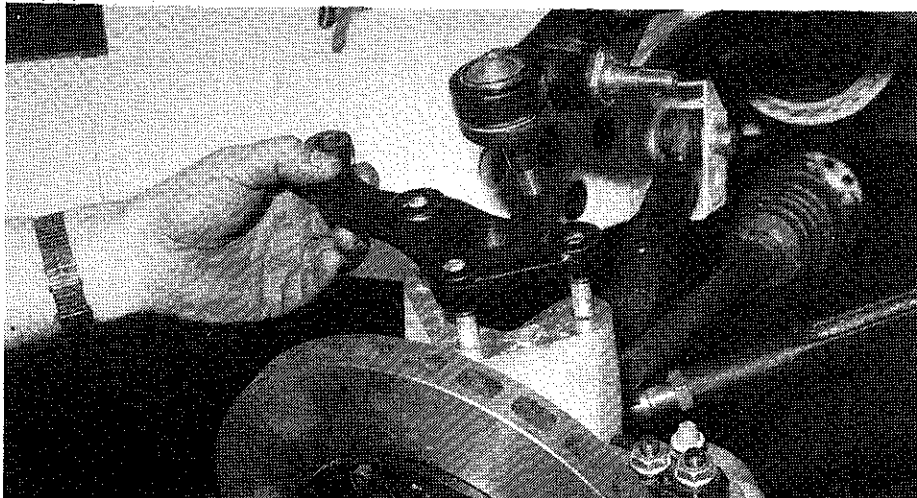

Front suspension bottom ball joint

This is sealed for life, and needs no normal maintenance. However, at some stage it may become necessary to change the ball joint, especially if the RS200 has habitually been driven hard on unsurfaced or rocky roads.

To remove

1. Jack up the front of the car, rest the chassis frame on stands, and remove the appropriate wheel.
2. Remove the four screws which hold the assembly to the front suspension upright. The lower wishbone assembly, complete with the ball joint, may now be dropped clear.
3. Disconnect the anti-roll bar drop link from the track control arm.
4. Remove the track control inner pivot bolt.
5. Remove the inner bolt fixing for the forward member of the lower wishbone assembly. The suspension member is now free and may be transferred to the workbench.
6. Loosen the ball joint/track control arm nut fixing, but do not remove it completely.
7. Lay the assembly on a vice, upside down, and - using a drift - 'break' the taper, so that the ball joint may be removed.

Re-assemble in reverse sequence.

Note: After making this change, it is essential that the castor and wheel camber settings should be checked and, if necessary, re-set.

Removing the suspension member

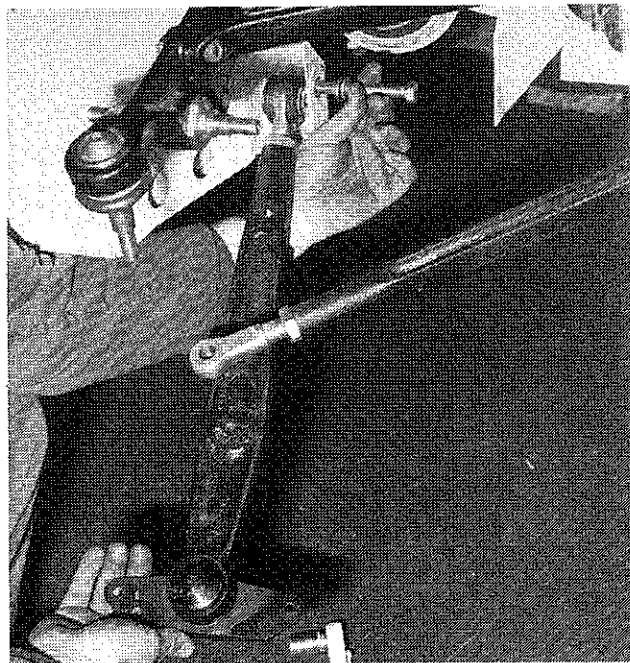

The ball joint and TCA components

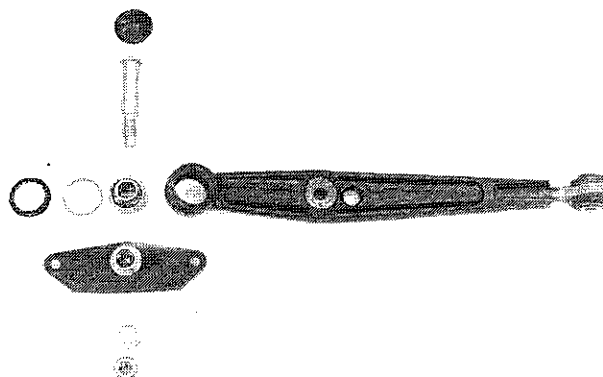

Front hub bearing

Because of the RS200's four-wheel-drive configuration, the front hub encloses a 'live' drive shaft. The hub bearing is packed with grease, and should be repacked after removal, or at every regular maintenance interval. (See Service).

Removal

1. Jack up the front of the car, rest the chassis on stands, and remove the appropriate road wheel.
 2. Remove the brake caliper, by undoing two bolts, wedge back the pads in their original positions, and hang up the caliper without breaking the hydraulic circuit.
 3. Disconnect the outer end of the drive shaft, by loosening and removing the nut, which is positioned in the centre of the brake disc.
 4. Remove the two Posidriv screws, and remove the brake disc over the dowels/wheel studs.
 5. Remove the front suspension upright, by removing three nuts, the upper wishbone and steering arm assembly at the top, and by loosening and removing four screws at the bottom.
 6. Leave the drive shaft in place, but transport the upright and hub to the workbench.
 7. Using a soft drift, knock out the hub and spacer, from the inner side of the upright.
 8. Remove five screws from the inside of the upright.
 9. Knock out the hub bearing, from the inner side, to the outside.
- Re-assemble in reverse order.

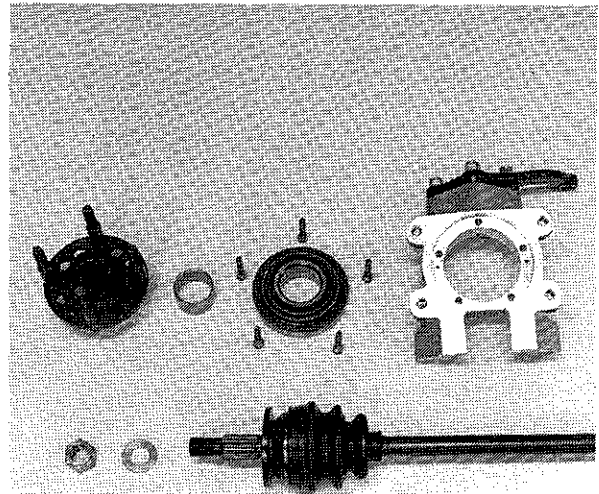
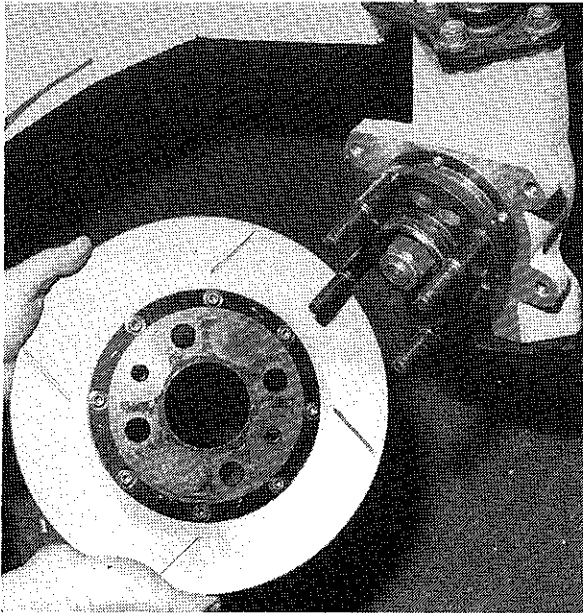

STEERING

Index

	Page Nos.
Toe-in/toe-out adjustment	54
Steering wheel	54
Steering column assembly	55
Steering rack assembly	56
Track rod ends	57
Steering arm	58

WWW.RS200.ORG

Front anti-roll bar

The RS200 has an anti-roll bar of fixed rate, mounted on the chassis frame, and linked to the bottom wishbone assembly by drop links of the type previously used in FORD Cortina models.

No regular maintenance is required. However, in view of the way in which the RS200 is likely to be driven, the owner is recommended to inspect the mounting bushes, and the drop link bushes, for wear, at every specified service interval.

Removal

Note: It is not necessary to remove the front wheels to remove the anti-roll bar, though access is somewhat easier if the wheels are removed.

1. Jack up the front of the car, and place on axle stands.
2. Remove the long through bolts from the drop links which tie the anti-roll bar to the front suspension bottom wishbones. Note, and preserve, the positions of all bushes, and washers.
3. Remove the nuts from both the anti-roll bar retaining clamps on the chassis.
4. The anti-roll bar may now be removed from the car after the retaining clamps are removed from the chassis.

Note: The bushes in the retaining clamps may be changed by loosening and removing one clamp at a time, or during the anti-roll bar change sequence.

Re-assemble in reverse sequence.

Uprating for serious Motorsport

It is intended to offer an adjustable anti-roll bar kit. See Optional Motorsport Parts section.

Adjusting the steering toe-in/toe-out dimension

Use conventional alignment checking equipment.

Check that the rack is correctly aligned to the straight-ahead driving position before the toe-in/toe-out dimension is set up. See 'Steering Rack', Section 07-54.

1. Loosen the track end lock nuts on each side of the car.
2. Rotate the tie rods, to screw the ball joint in or out, as required.
3. Check that the rack rubber gaiters have not been displaced, or damaged, by this action.
4. Make the same adjustment to each side of the steering gear, never to one single side, or this will result in imperfect steering geometry, and the steering wheel will also be 'off-centre'.
5. Re-tighten the lock nuts.
6. Check, then re-check, the alignment after tightening up the linkage.

[It is recommended that the car should be rolled forward and back before and after making the changes, to allow the steering and the suspension to 'settle' in its normal position.

Always carry out the checks, and the adjustment, on level, hard, ground.

The standard setting for the RS200 is that the wheels should be absolutely parallel, with neither toe-in, nor toe-out.

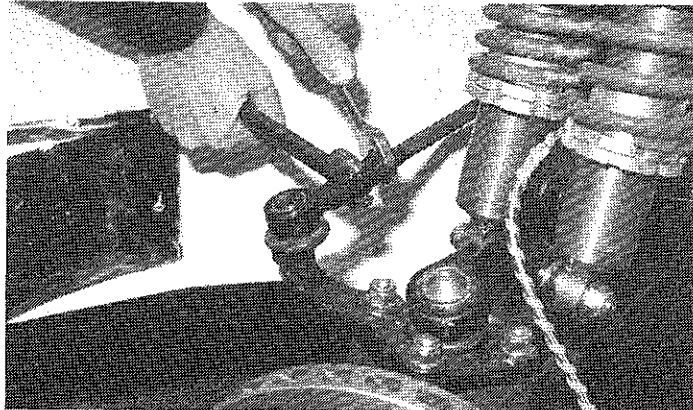

Steering Wheel

The RS200 steering wheel has a leather-covered rim, and three spokes.

Removal

1. Gently prise off the decorative cover in the centre of the steering wheel, with a blunt-edged screwdriver.
2. Remove the retaining nut.
3. It should now be possible to withdraw the steering wheel.

Re-assemble in reverse sequence.

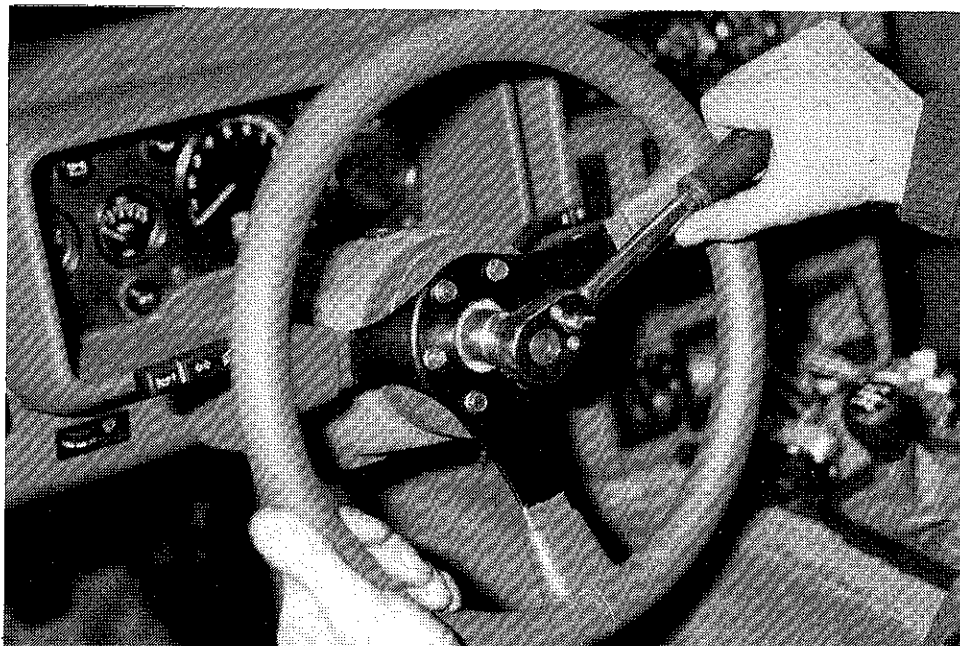

Steering column assembly

This is a modified FORD Sierra component, and supports the FORD switch gear at the top of the column, behind the steering wheel. It is connected by a universal joint to the rack and pinion steering gear. The RS200 may have left-hand steering, or right-hand steering; the principles of the steering column are always the same.

Removal

1. Remove the steering wheel (described elsewhere).
2. Remove the column shroud plastic housings, by removing the screws, and lifting the housings clear.
3. Disconnect the electrical switch gear (see Electrical section).
4. Remove the front body section release lever, and cable, from the assembly.
5. Disconnect the steering column from the steering rack universal joint, by removing the top pinch bolt.
6. Mark the relationship of the steering column to the universal joint, to assist correct re-assembly.
7. Disconnect the column from lower support bracket - two bolts.
8. Loosen, and remove, the long through bolts, securing the upper column to the bulkhead bracket, noting the adjustment position.
9. Withdraw the column through the bulkhead, into the cockpit, and remove from the car.

Re-assemble in reverse sequence.

Note: Detail stripping and rebuilding of the column itself should be carried out as for the FORD Sierra - see the Sierra Workshop Manual, pages 13A-16, and 13A-17..

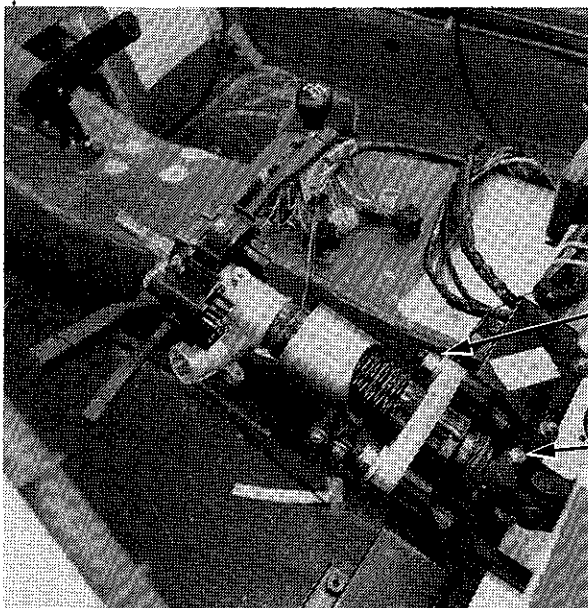
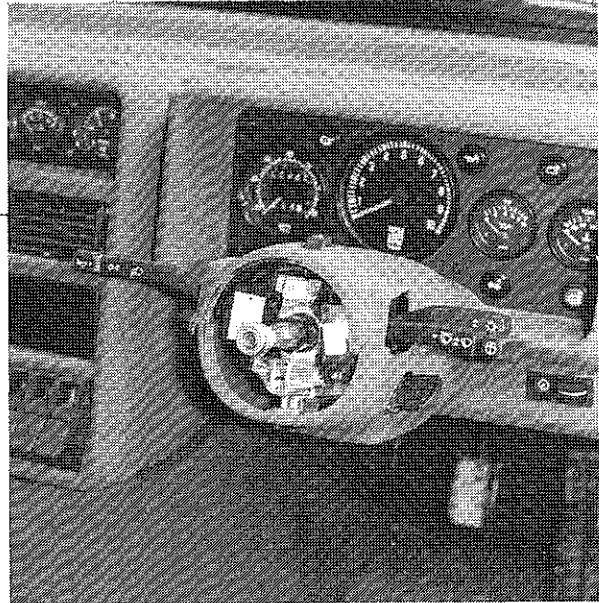
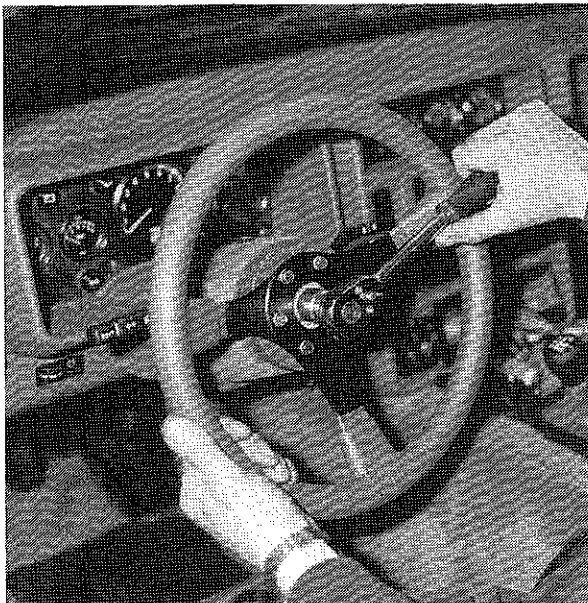

Lower support bracket bolts

Top pinch bolt

WWW.RS200.ORG

Steering rack

The RS200 has rack-and-pinion steering, and is available in left-hand-drive or right-hand-drive form. The rack is bolted to a front chassis cross-member, and is behind the line of the front drive shafts. There is no power assistance, and there are 2.6 turns from lock to lock.

The helically cut pinion is supported by a parallel roller bearing at its lower end, and a non-adjustable ball bearing above the pinion teeth.

At the specified service intervals, the rack assembly should be checked for damage or wear in the linkage, to the ball joint covers, and to the gaiters for security and condition.

The rack has been centralised off the car, when first assembled, and was marked with a paint line from the pinion to the pinion boss. Any replacement rack must also be accurately centralised before fitment to the car.

Removal

1. Jack up the front end of the car, and rest it on axle stands.
2. Remove the Nyloc nuts from the ball joint connecting the rack to the steering arm.
3. Using a ball-joint separator, release the taper, and release the track rod ends from the steering arm.
4. Mark the alignment of the universal joint linking the steering rack to the steering column, remove the pinch bolt, and disconnect the U/J from the column.
5. To aid access, remove the chassis bracket over the rack, which connects the chassis to the bulkhead - four bolts.
6. Remove both bolts fixing the steering rack to the chassis cross member.
7. The rack may now be extracted sideways.

Re-assemble in reverse sequence.

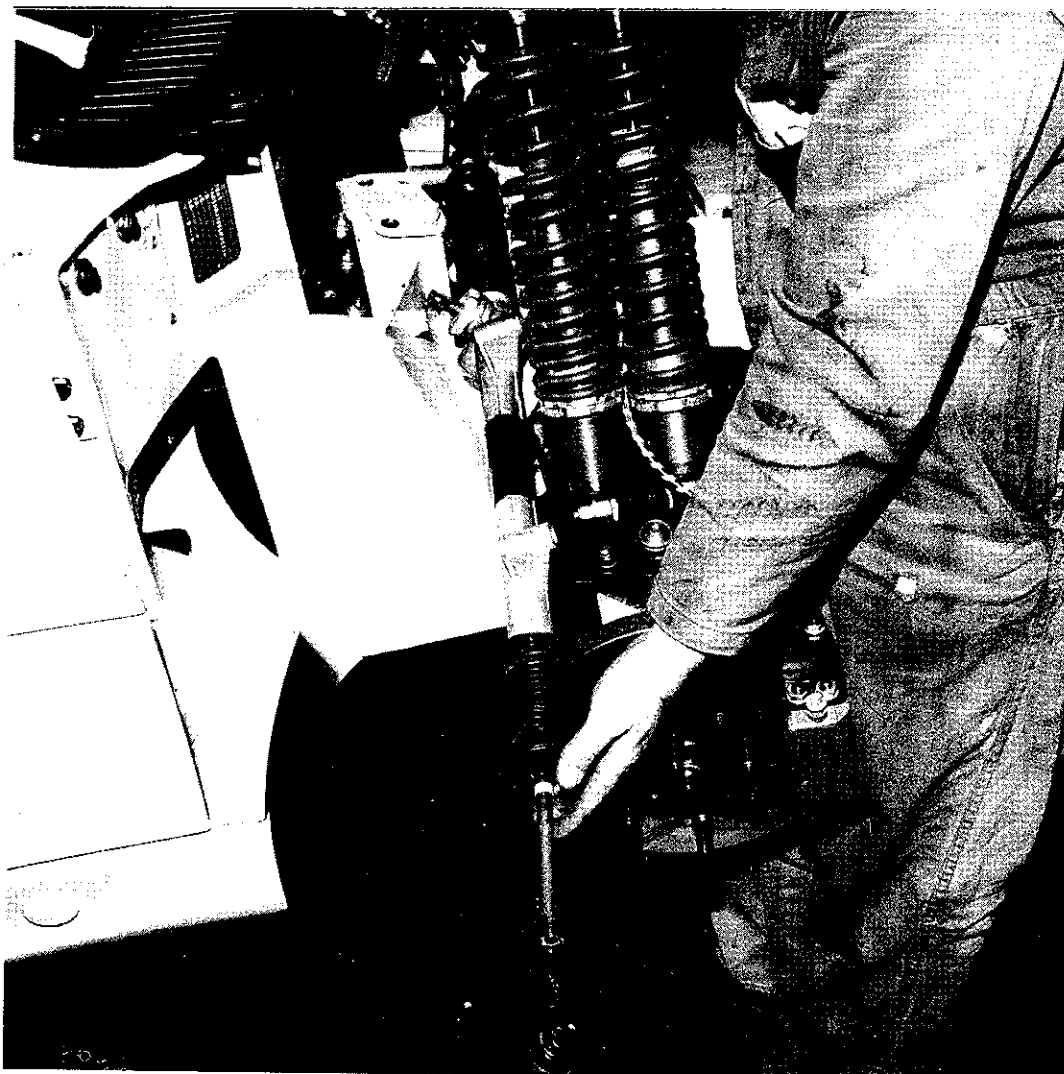

Fitting a replacement steering rack

Before fitting a new rack to the vehicle, set up the rack at the centre of its travel, on the work bench, and mark this position, with a touch of paint on the pinion shaft, and on the adjacent housing.

Install it in the vehicle, then set the tie rods so that the road wheels are parallel to the centre line of the car (Refer to the underbody/monocoque side members, which are also parallel to this centre line). At all times, ensure that the tie rods are adjusted to the same length.

Final adjustment of the toe-in/toe-out setting should then be carried out in the way already described.

To set the steering wheel straight, use the steering column top hexagon for coarse adjustment, and the bottom column connection (universal joint to pinion) for fine adjustment.

Upgrading for serious Motorsport

It is proposed to offer two distinctly different steering rack and pinion kits for use in motorsport:

1. High-ratio racks, for off-road use.
2. Power-assisted steering kits, complete with engine pumps, belts and brackets.
– See Optional Motorsport Parts.

Track rod end removal and replacement

Loosen the track rod end lock nut, then separate the ball joint from the steering arm.

Fit the new track rod end, then remember to check and re-set the toe-in/toe-out dimensions. On the RS200, the front wheel setting is Parallel wheels.

Steering rack change

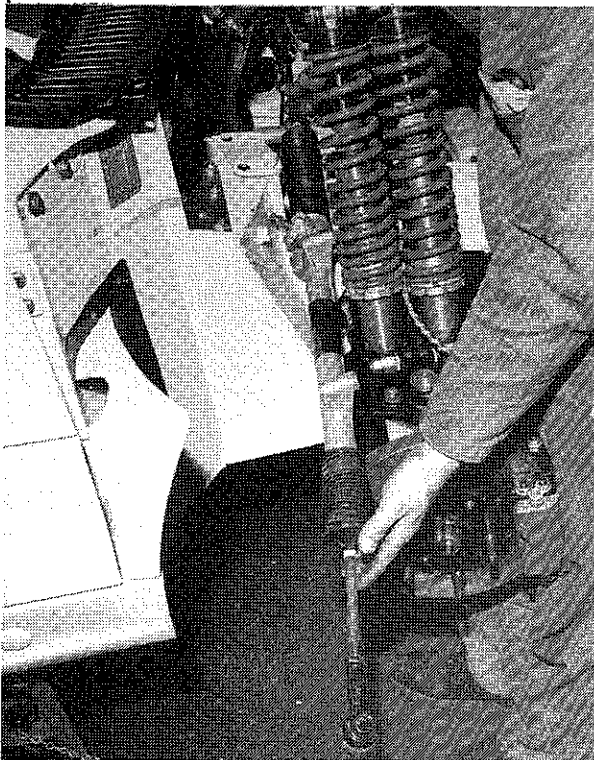

Track rod end removal

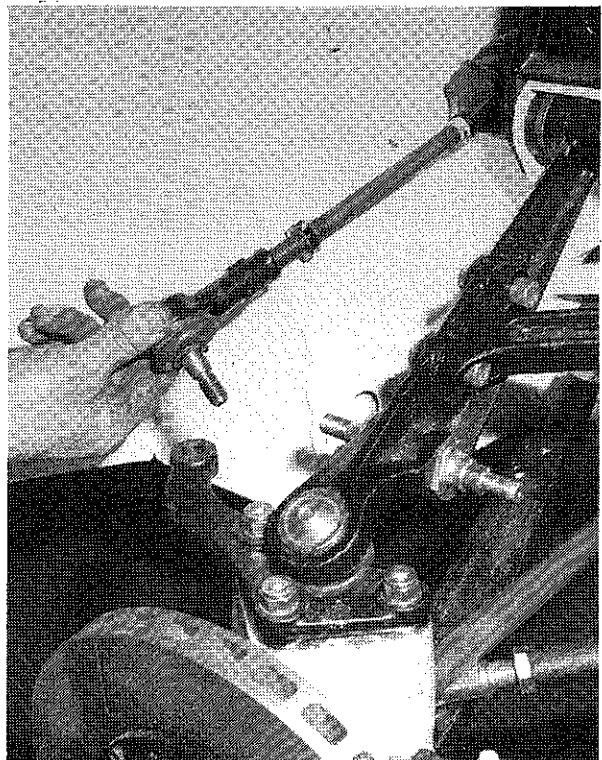

Steering arm

This is fixed to the head of the cast front suspension upright, by three studs and nuts, and partially surrounds the suspension's upper ball joint.

At some stage, it may be necessary to change this arm.

Removal

1. Jack up the front of the car, and rest the chassis frame on axle stands.
 2. Remove the appropriate front wheel, to give easy access.
 3. Remove the Nyloc nut from the ball joint connecting the steering arm to the steering trackrod.
 4. Using a ball joint separator, release the taper, and release the steering arm from the ball joint.
 5. Loosen the suspension ball joint securing nut, insert a metal spacer between the upright casting and the ball joint screw thread, then wind down the nut to 'break' the adhesion of the taper (see Front Suspension, Top Ball Joint). Remove the nut.
 6. Push down the upright sufficiently to clear the ball joint stud, and swing out the upright.
 7. Remove the three fixings holding the steering arm to the upright, and remove the steering arm.
- Re-assemble in reverse sequence, ensuring that both relevant ball joint tapers are rust, grit, and paint free before doing so.

N.B. After completion of any major service work on front suspension bump steer must be checked and adjusted if necessary (see 07-43).

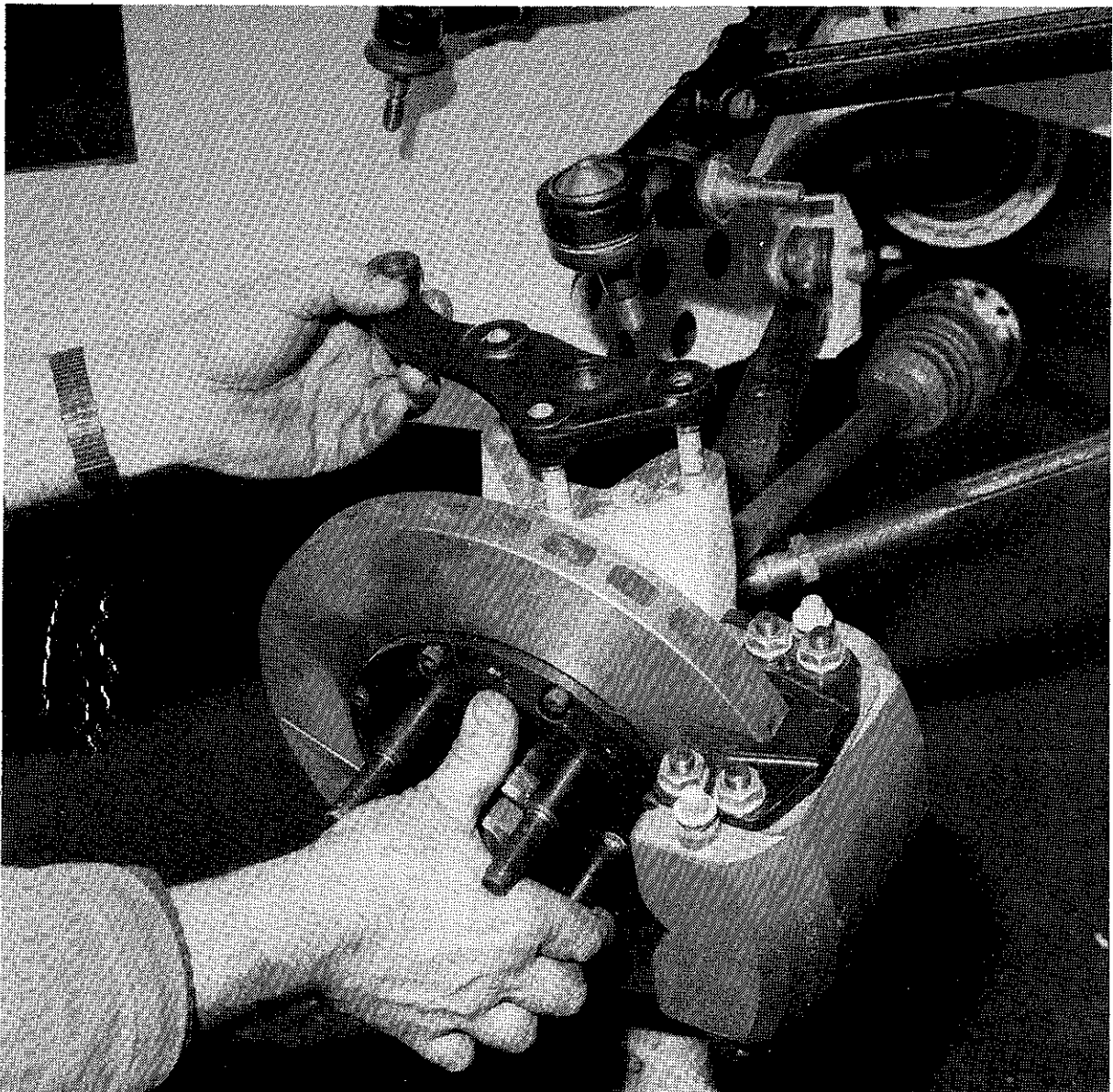

REAR SUSPENSION

	Page Nos.
Ride height adjustment	60
Coil spring/damper units	62
Lower wishbone, inner bushes	63
Upper wishbone, inner bushes	63
Upper wishbone, outer joint	64
Adjustable toe-in/toe-out control rod	65
Control Rod Rose Joint	66
Rear anti-roll bar	67
Lower wishbone, outer joint	68
Rear hub bearing	69

WWW.RS200.ORG

Rear suspension ride height adjustment

 **WARNING**—This short section should be read in conjunction with the similar section concerning the front suspension. A change to the rear suspension ride height should **only** be carried out at the same time as a similar change to the front suspension ride height.

It is *not* recommended, for instance, that the RS200 should be used with the front suspension ride height set for maximum ground clearance, and the rear suspension ride height set for minimum ground clearance. The standard RS200 is built, and delivered to its owner, with the suspension geometry optimised for normal driving on surfaced roads. In this condition, at the rear of the car, the inner (chassis) mountings of the suspension wishbones are in the *uppermost* of their alternative pivot positions, and the inner end of the toe-in control rod has its *shortest* spacer *above* its spherical joint - ride height is 180 mm.

If extra ground clearance is required, where the RS200 is to be driven habitually over rough surfaces, the chassis structure must be raised, relative to the wheels and the suspension linkage. To do this, the inner (chassis) mountings of the upper and lower wishbones have to be moved to the *lowermost* of the alternative positions.

At the same time, the spacer arrangement supporting the spherical joint at the inner end of the toe-in control rod must also be changed. For rough-road running, this joint must have a short spacer below it, and the *longer* spacer *above* it. Please note: this change *cannot* be made merely by reversing the position of the existing spacers. A car set of new spacers must be obtained, by contacting FORD Motorsport Parts Division.

DO NOT make this change to the upper wishbone alone, or to the lower wishbones alone. The change must be made to upper wishbone, lower wishbones links and to the toe-in control rods, all at the same time, or the carefully evolved suspension geometry, and the handling, of the RS200 will be adversely affected. If you carry out this modification, check right round the rear suspension – a total of five inner joints are involved at each side of the car – before driving it once again. In addition, check, and if necessary, re-adjust the camber and the toe-in of the suspension.

The difference between 'normal' and 'raised' ground clearance, at the rear of the car, is approximately 25mm/1.0in.

WWW.RS200.ORG

REAR SUSPENSION PIVOT POSITIONS

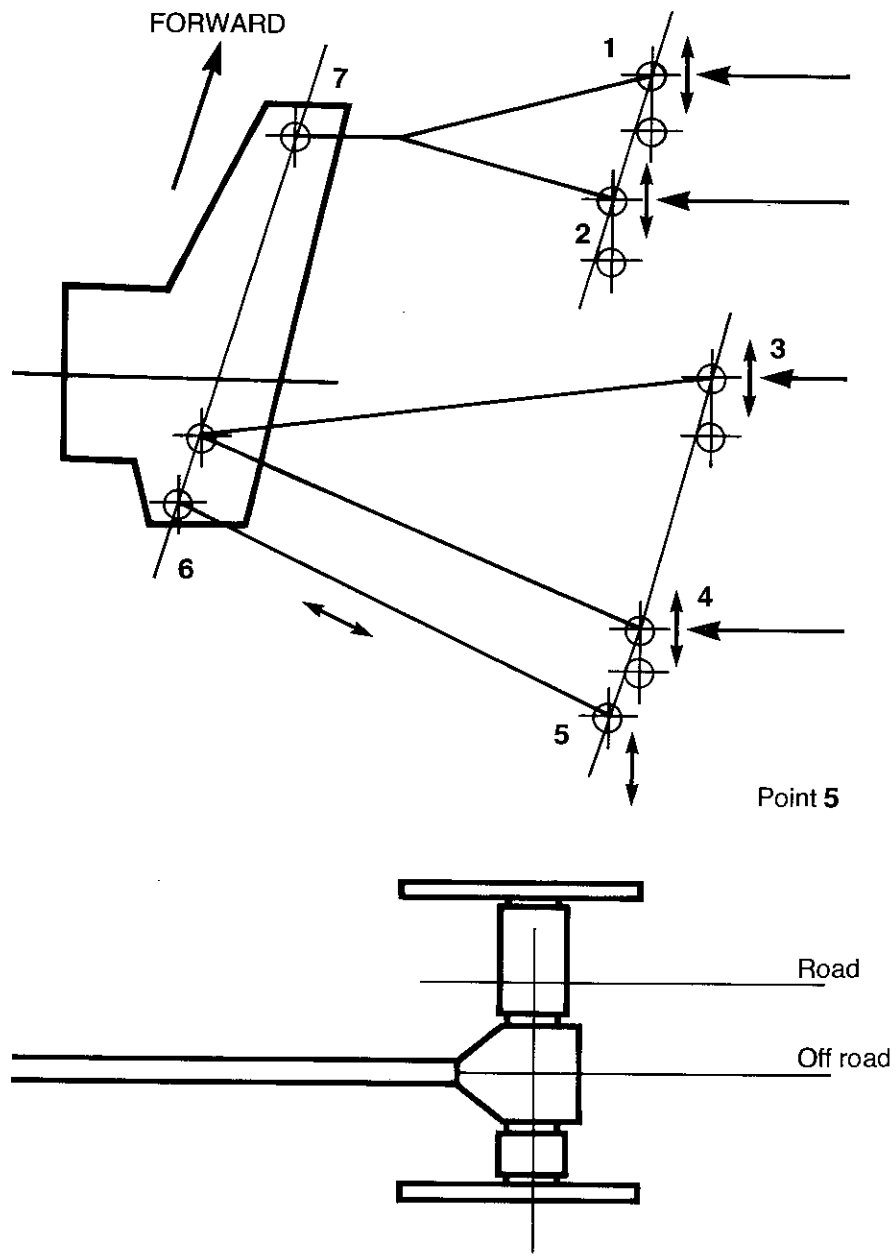

WWW.RS200.ORG

Point 1 2 ride height adj.
Point 3 4 ride height adj.
Point 5 6 toe control adj.
and adj. with ride height
Point 7 camber adj.

REAR SUSPENSION ADJUSTMENTS

NB. Ride height adjustment may only be carried out with 1/2 tank fuel and the weight of two people eg 85 kilo per seat.

Rear suspension coil spring/damper units

These carry out the same functions, and are changed, and adjusted, in exactly the same way as those fitted to the front suspension.

For all details regarding exchange, and adjustment, refer to the section covering Front Suspension.

WWW.RS200.ORG

Lower wishbone, inner bushes

As with the upper wishbone inner pivots, these require no special maintenance attention.

To change them, it is necessary to remove the lower wishbone from the car:

1. Jack up the car at the rear, support the chassis on axle stands, and remove the appropriate wheel, for easier access.
2. Disconnect the link between the anti-roll bar, and the wishbone.
3. Loosen the pivot connection between the suspension upright, and the outer end of the lower wishbone.
4. Loosen and remove the pivot for the inner end of the toe control arms, and swing this rod clear, to give access to the inner wishbone's rear pivot bolt, noting spacer positions. Remove the two wishbone inner mounting pivot bolts, and the outer pivot bolt.
5. Remove the two wishbone inner mounting pivot bolts.
6. The wishbone may now be removed from the car, to the workbench.
7. The bushes may now be extracted, and new bushes inserted in their place.

Re-assemble in the reverse sequence, checking that the toe-in/toe-out settings have not been disturbed in the process. Ensure that the correct location of spacers, above and below the inner Rose joint of the toe-in/toe-out control rod, has been preserved. When the car is set up in its normal on-road state, the longest spacer should be below the Rose joint, the shortest spacer above it; the Rose joint should be at the same height as the lower wishbone bolts.

Upper wishbone, inner bushes

These are of the same type as those fitted to the upper wishbones of the front suspension, and require no special maintenance attention.

To change them it is necessary to remove the upper wishbone from the car:

1. Jack up the rear of the car, support the chassis on axle stands, and remove the appropriate wheel, for easier access.
2. Disconnect the lower pivots of the suspension spring/damper units, and swing them clear, to allow access to the bolt linking the upper wishbone to the suspension upright.
3. Remove the upper pivot bolt, thus freeing the outer (Rose) joint from the suspension upright.
4. Loosen and remove the pivot bolts holding the upper wishbone to the chassis structure. The wishbone assembly may now be removed to the workbench.
5. The rubber bushes may now be extracted, and new bushes put in their place.

Re-assemble in the reverse sequence.

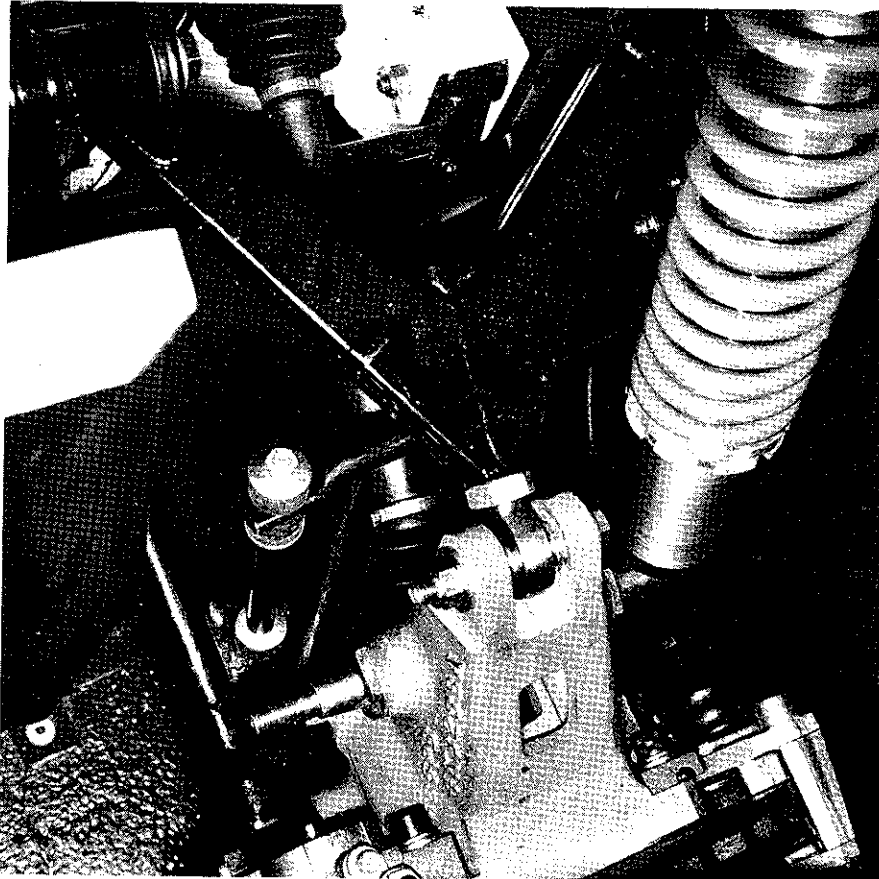

Upper wishbone, outer joint (to suspension upright)

The upper wishbone is linked to the suspension upright by an adjustable Rose joint, which allows the wheel camber to be changed, if necessary. This Rose joint requires no special maintenance.

To adjust the camber, loosen the Rose joint lock nut, remove the bolt securing the Rose joint to the upright, and screw it in or out of the wishbone, as required. After adjustment, lock the locknut securely, and re-check the camber. Repeat the operation, if further adjustment is required.

Always ensure that you are running the same static camber on each side of the car. The recommended figure, using standard sheels and tyres, is 1 degree negative (which means that the wheel and tyre leans slightly inwards, towards the centre line of the car, at its top), in the unladen state.

To change a Rose joint:

1. Jack up the car, and rest the chassis frame on axle stands.
2. Remove the appropriate road wheel.
3. Disconnect the lower pivots of the suspension spring/damper assemblies, and swing them clear, to allow access to the bolt linking the wishbone to the upright.
4. Loosen the lock nut which fixes the Rose joint to the wishbone.
5. Remove the upright pivot bolt, thus freeing the Rose joint from the upright.
6. Swing the wishbone clear, and unscrew the joint from the wishbone.

Re-assemble in the reverse sequence.

Note: After re-assembly, ensure that the Rose joint is correctly aligned, and centralised, between the faces of the upright.

After re-assembly, check, adjust, and set the camber of the rear suspension.

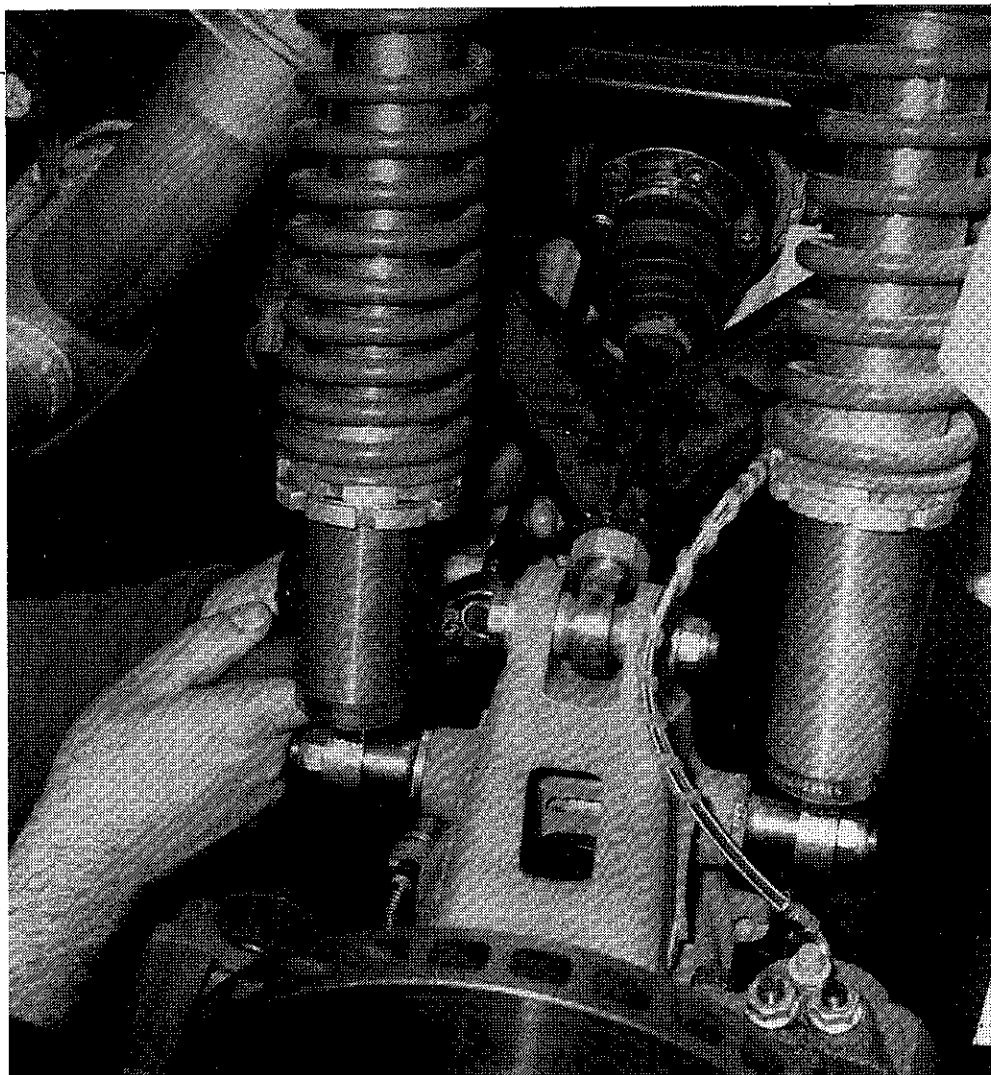

Adjustable toe-in/toe-out control rod

Although the rear suspension has conventional double wishbone suspension geometry, there is also an additional adjustable, member, which allows the toe-in/toe-out settings of the rear wheels to be adjusted. This is a rod linking the lower rear corner of the appropriate rear suspension upright to a bracket clamped to the rear chassis plate, adjacent to the lower wishbone rear inner pivot.

To adjust the toe-in/toe-out:

1. Jack up the rear of the car, insert conventional toe-in checking platforms under the rear wheels, then lower the car on to these platforms and remove the jack.
2. Loosen the lock nuts which are located at each end of the control rod.
3. Rotate the arm, as necessary, to increase or decrease its effective length.
4. Lock up the lock nuts, and re-check the new settings. Repeat the exercise, if necessary.
5. Re-check the settings once again when the turntables have been removed.

*Note: Always make equal adjustments at each side of the car, never on one side only.
The recommended setting is: 0 deg. 15min. toe-in.*

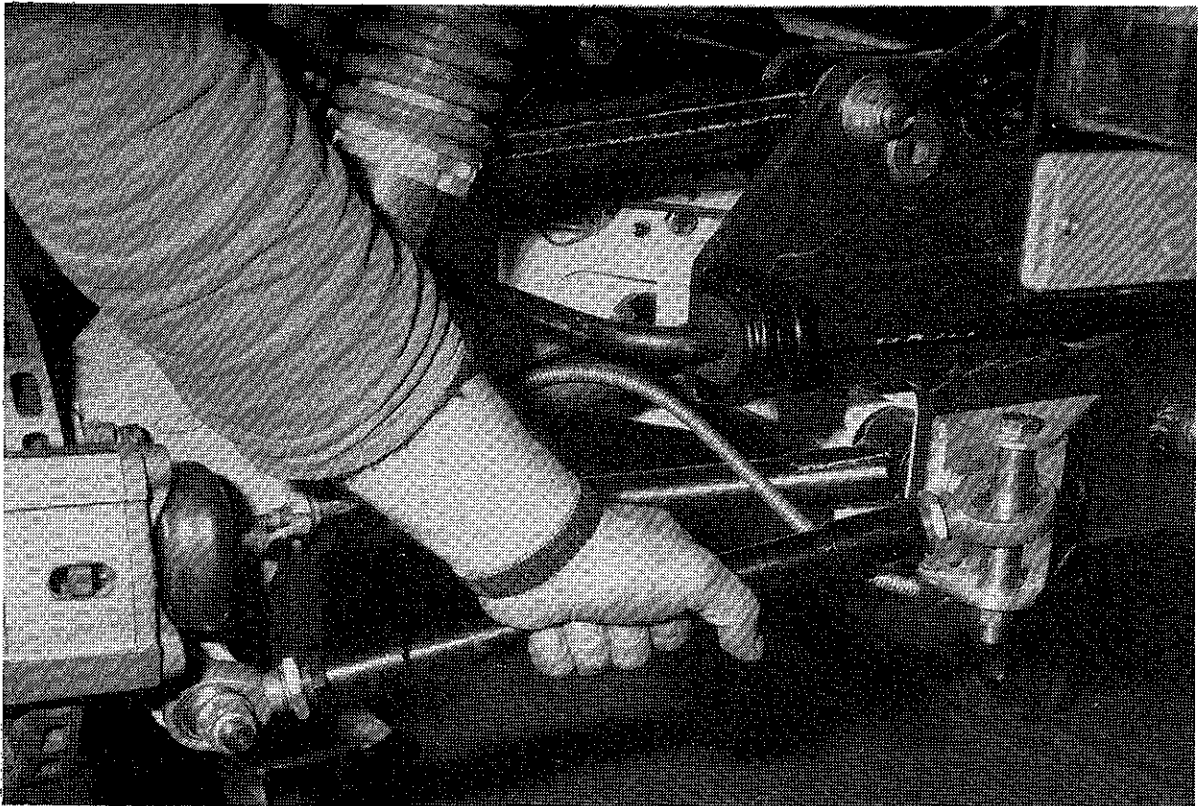

WWW.RS200.ORG

To change a toe control arm Rose joint:

1. Jack up the rear of the car, support the chassis on axle stands, and remove the appropriate wheel, for easier access.
2. Loosen the Rose joint/control arm lock nut, as appropriate.
3. Remove the appropriate pivot (outer, at the upright, or inner, at the chassis bracket), and swing the arm clear.
4. Unscrew, and remove the old Rose joint.

*Note: the outboard Rose joint has a left hand thread (i.e., it unscrews **clockwise**) and the inboard Rose joint has a conventional right hand thread (i.e., it unscrews **anti-clockwise**).*

Re-assemble in reverse sequence. However, ensure that the correct spacer position is preserved at the inner joint, above and below the Rose joint. When the car is set up in its normal on-road state, the longest spacer should be below the Rose joint, the shortest spacer above it. See Section 07-61.

When re-assembling, always centralise the joints in their housing and re-check (and, if necessary, adjust) the toe-in/toe-out settings as required.

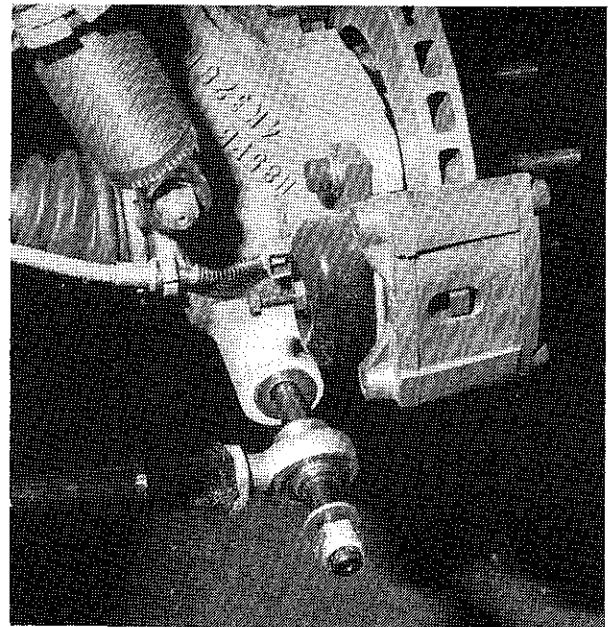
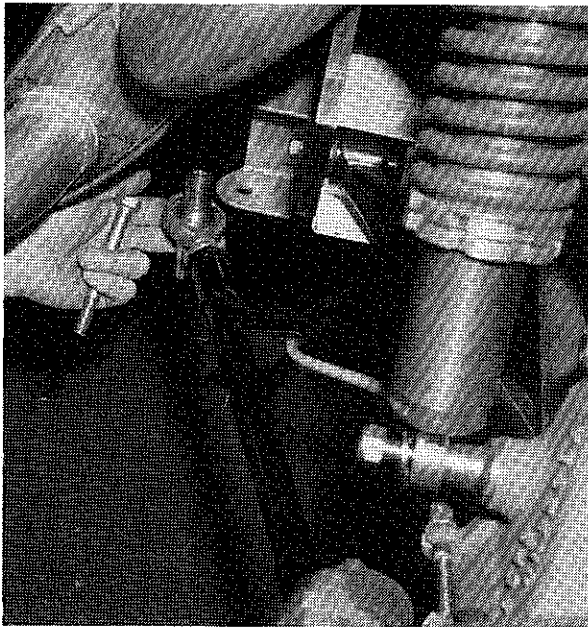

WWW.RS200.ORG

Rear anti-roll bar

The RS200 has a rear anti-roll bar of fixed rate, which is mounted on the back of the rear chassis plate, and linked to the bottom wishbone assembly by drop links of the type previously used in FORD Cortina models.

No regular maintenance is required. However, in view of the way in which the RS200 is likely to be driven and used, the owner is recommended to inspect the mounting bushes, and the drop link bushes, for wear, at every specified service interval.

Removal:

Note: It is recommended that both the rear wheels are removed, so that access to the fixings and links is eased, and the removal of the bar itself is also made more simple.

1. Jack up the rear of the car, and support the chassis on axle stands.
2. Remove the long through bolts from the drop links, which tie the anti-roll bar to the rear suspension bottom wishbones. Note, and preserve, the positions of all bushes, and washers, in this drop link.
3. Remove the nuts from both the anti-roll bar retaining clamps (two for each clamp), which fix them to the chassis plate.
4. The anti-roll bar may now be removed from the car after the retaining clamps have been withdrawn from the chassis plate, initially by drawing the bent end of the bar rearwards, then swivelling that downwards through the links of the bottom wishbone.

Note: The bushes in the retaining clamps may be changed by loosening and removing one clamp at a time, without removing the anti-roll bar, or during the anti-roll bar change sequence.

Re-assemble in reverse sequence, making doubly sure that all bushes and washers in the drop links are correctly positioned.

Uprating for serious motorsport

It is intended to make available an adjustable anti-roll bar kit. See Optional Motorsport Parts.

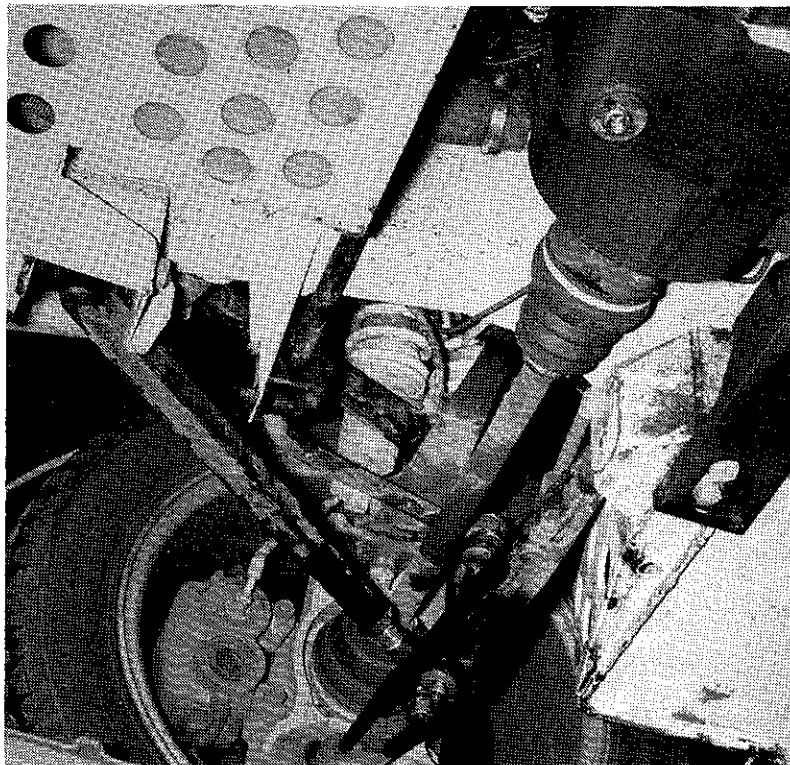

Lower rear wishbone, outer joint

The lower wishbone is linked to the forward lower face of the suspension upright by a spherical joint, fixed by a nut and stud to the upright itself.

No regular maintenance is needed.

To remove:

1. Remove the entire lower wishbone from the car (as described under *inner* bush removal).
2. Remove the circlip holding the spherical joint in place.
3. Remove the spherical joint from the wishbone.

Re-assemble in the reverse sequence.

Note: Having re-assembled the rear suspension, check that the necessary toe-in/toe-out, and camber settings have not been disturbed. Re-adjust and re-set these, as necessary.

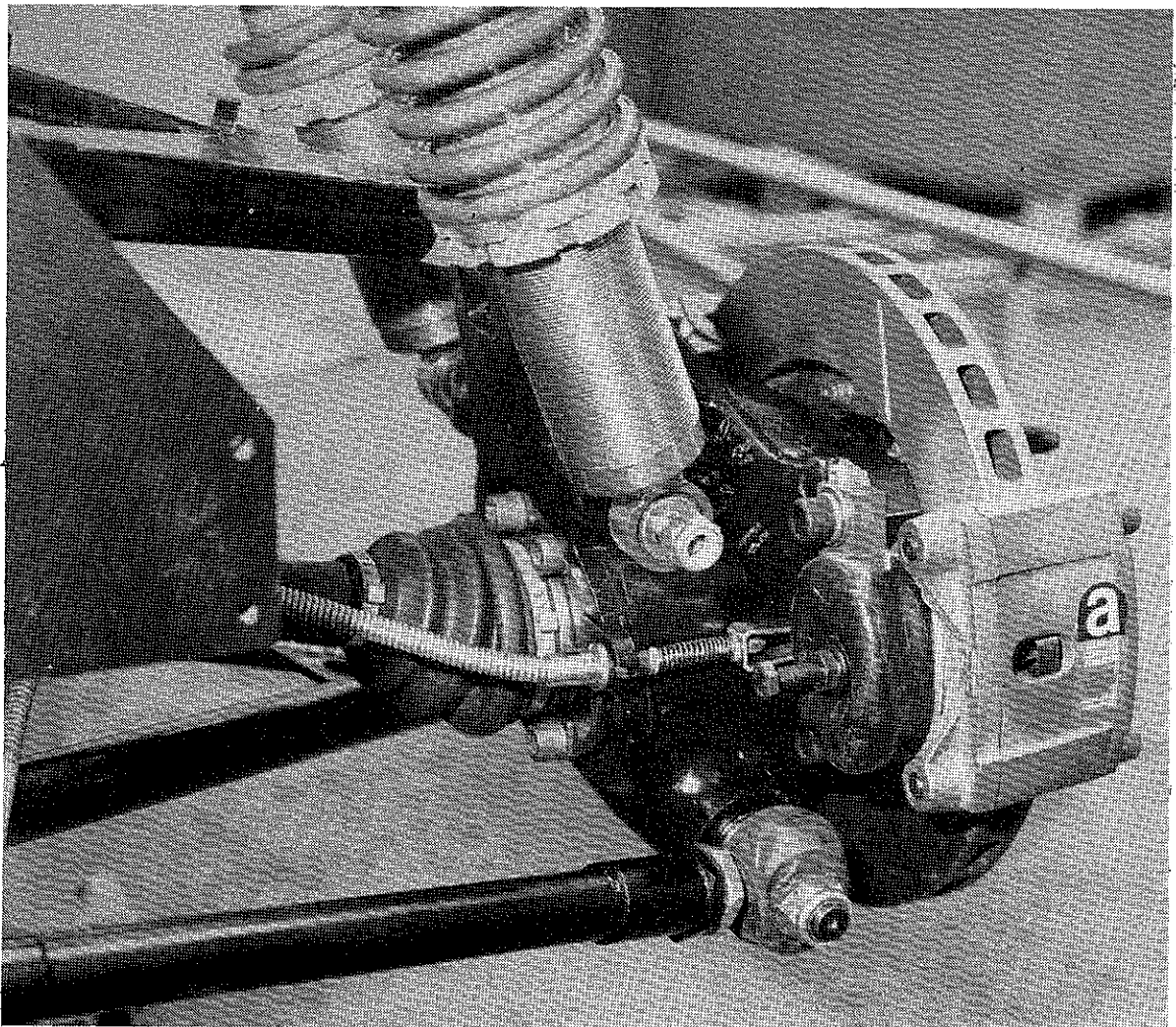

Rear hub bearing

Instructions regarding the changing of rear hub bearings will be issued at a later date, when the full range of replacement bearing spacers becomes available.

WWW.RS200.ORG

BRAKING SYSTEM

Index

	Page Nos.
Brake bleeding procedure	71
Brake pads – footbrake calipers	72
Brake pads – handbrake calipers at rear wheels	73
Brake master cylinder	74
Brake discs, front and rear	75
Handbrake lever	76
Primary handbrake cable	77
Secondary handbrake cable	78

WWW.RS200.ORG

Brake bleeding procedure

The procedure for bleeding the brakes of the RS200 is conventional, as for any other car with hydraulic brakes, except for:

To avoid putting unnecessary strain on the brake balance mechanism (which is located in the pedal box assembly), when carrying out any bleeding operation, always ensure that one front *and* one rear brake line are open, and being bled, at the same time.

WWW.RS200.ORG

Brake Pads: Hydraulically operated footbrake calipers

The same brake discs, footbrake calipers, and pads are fitted to the front and rear wheels of the RS200, and the changing procedure is the same for front or rear brakes.

Removal:

1. Jack up the car, and remove the appropriate wheel.
2. Remove four nuts from the caliper end plate, which covers the pads.
3. Push back the hydraulic pistons, into their cylinders, before disturbing the pads, and ensure that no fluid is displaced out of the top of the brake reservoir in the front compartment of the car.
4. Remove the worn pads.
5. At this point, check that the pistons are free to move in their calipers, and that the discs themselves are in good condition. Check that the pad location areas are clean, and use a touch of approved lubricant to allow pads to move freely.

Re-assembly is in the reverse order, checking that the new pads seat properly, and that the pistons are still free to move correctly.

Upgrading for serious motorsport

See *Optional Ford Motorsport Parts* section.

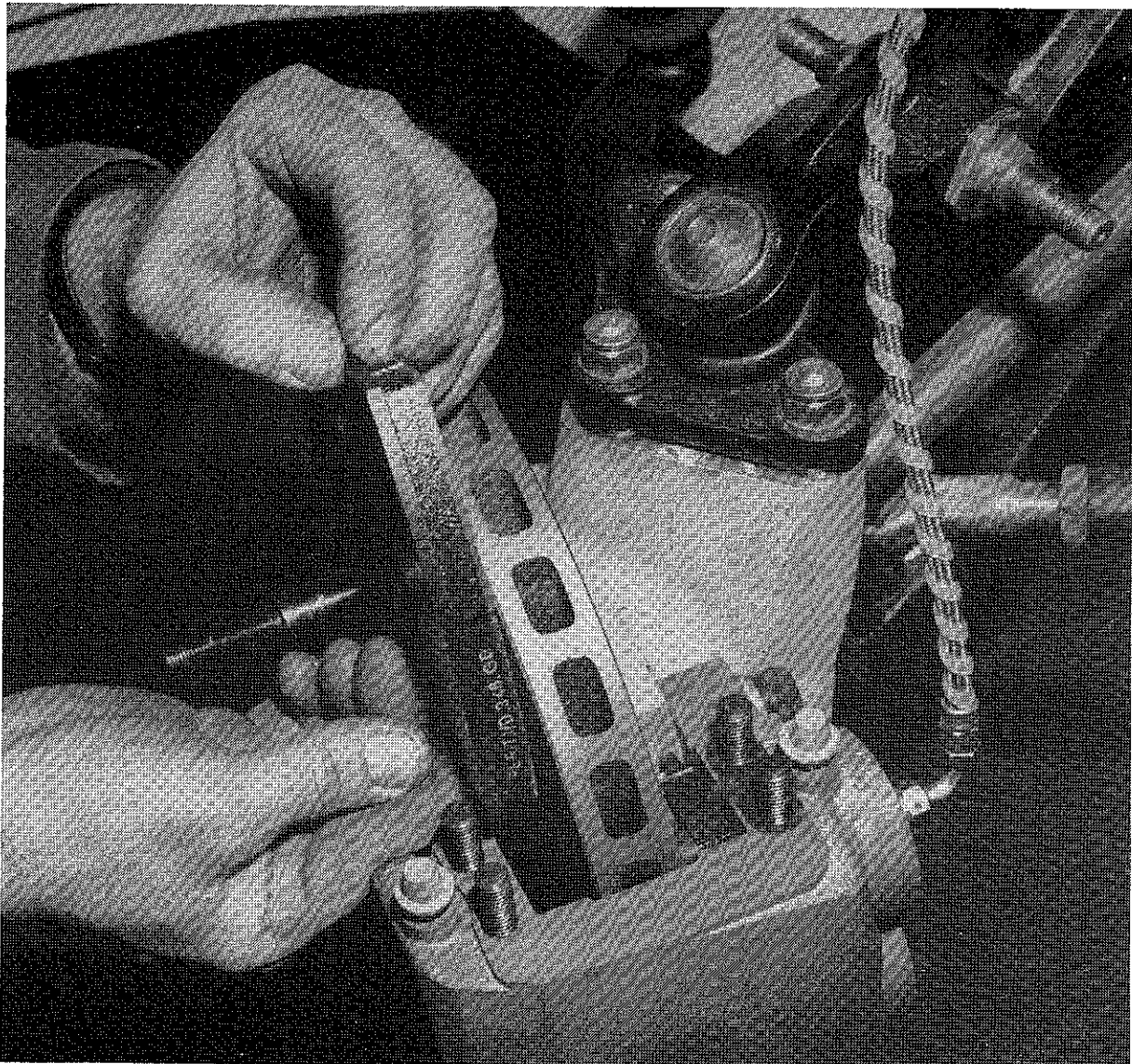

Brake pads: Handbrake calipers at the rear wheels

The handbrake operates, mechanically, on a separate pair of calipers, mounted behind the line of the rear drive shafts. Although these AP units operate on the same brake discs, they are completely independent of the footbrake caliper system.

Removal:

1. Jack up the car, and remove the appropriate wheel.
2. Ensure that the handbrake is in the fully 'OFF' position.
3. Slacken off, and remove, the two Allen socket bolts on the outside of the calipers.
4. Withdraw the caliper end plate, and centre spacer, complete with pads and pins, noting details at this stage.
5. Slacken off the adjustment on the inside of the caliper, until the inner pad plate rests against the caliper body.
6. Thoroughly clean all components before reassembly.
7. Fit new pads, and re-assemble in reverse order.

Adjustment:

1. Take up the adjustment until the disc is clamped.
2. Undo the adjustment by one quarter of a turn, when the disc should be able to rotate freely.
3. Relock the adjustment.
4. By actuating the handbrake lever, check that the operation is satisfactory, and that the disc rotates freely after the lever is released.

Installation

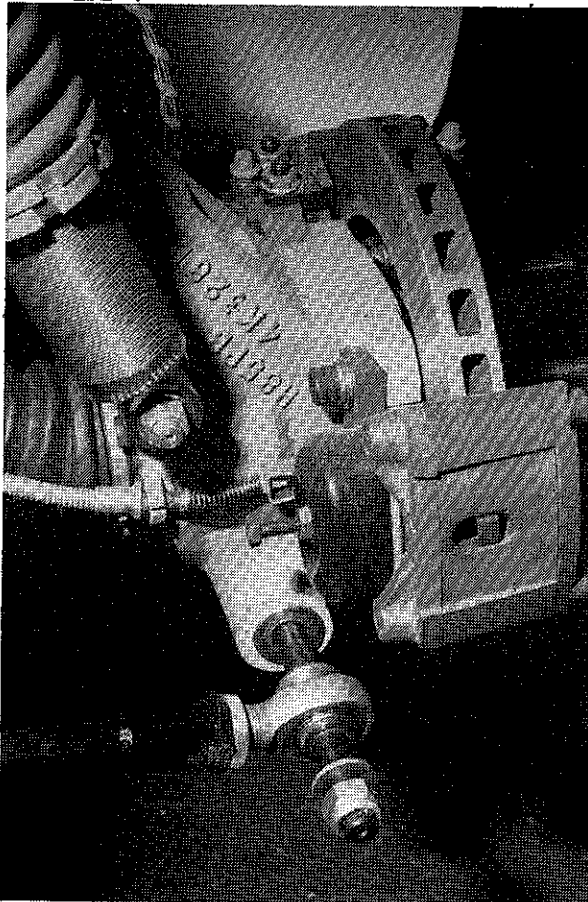

Caliper Removal

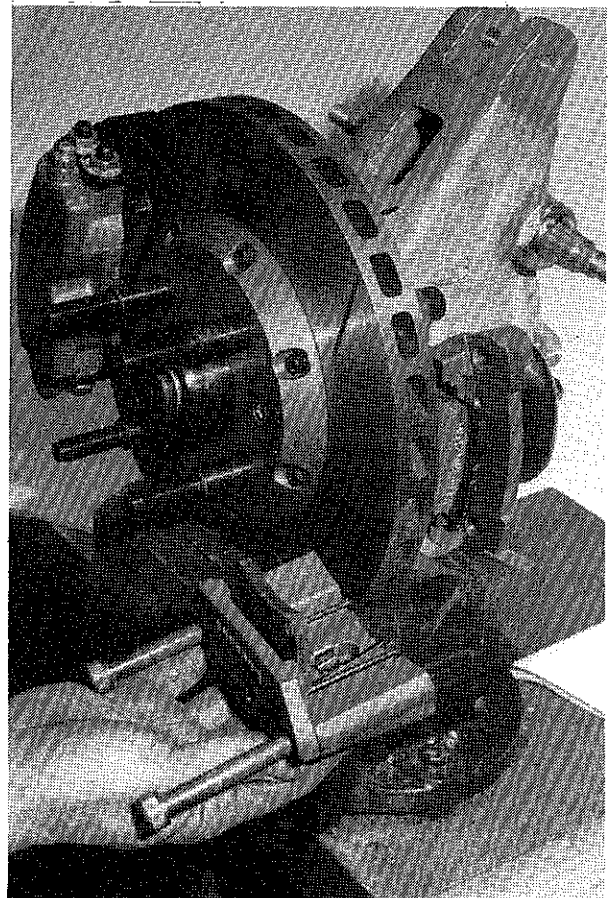

Brake master cylinder

Two master cylinders are mounted, side by side, ahead of the driver's toeboard, and the pedal box. Each has its own separate hydraulic fluid reservoir. One controls braking effort to the front wheels, and the other to the rear wheels. Both are connected to the brake pedal by a fixed balance bar, which is located behind the toeboard, in the pedal box.

Removal:

Note: If any brake fluid is spilled on paintwork, the affected area should immediately be washed down with cold water.

1. Drain the appropriate hydraulic system, by opening one caliper bleed nipple, and pumping to clear. It is **IMPORTANT** to note that extra resistance will be felt on the pedal, part-way down the pedal stroke. Do **NOT** attempt to press the pedal further down than this when clearing the system, as this may derange the balance bar.
2. Locate the brake balance bar, which is to be found inside the pedal box, in the driver's footwell, close to the pedal pivots.
3. Remove the circlip from the end of the balance bar, then slide the pushrod yoke off the balance bar.
4. Disconnect the reservoir pipe from the master cylinder, and the brake line from the master cylinder.
5. Undo both retaining bolts, and withdraw the master cylinder for attention.
6. Note that, for re-assembly purposes, the dimension from the master cylinder/pedal box mounting face to the centre line of the yoke should be accurately retained.

Re-assemble in reverse order, noting our advice about bleeding methods.

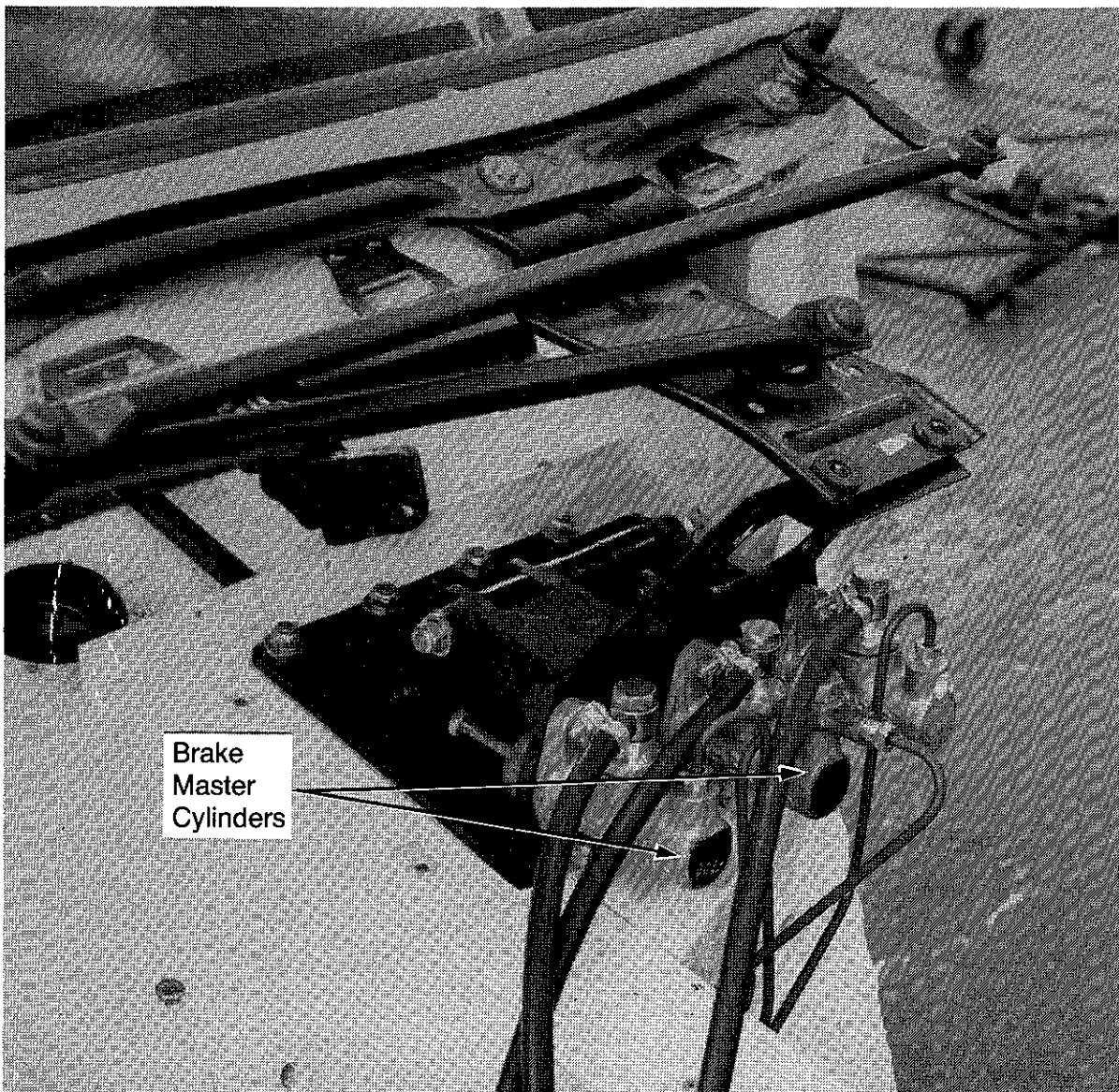

Brake discs – front and rear

The discs are ventilated, are only attached to the hub by locating Posidriv screws, but firmly clamped into place by the road wheels.

Removal:

1. Jack up the appropriate wheel, and support that corner of the car on stands.
2. In the case of the rear wheels and discs, ensure that the handbrake is in the 'OFF' position.
3. Remove the appropriate road wheel.
4. Remove the hydraulic brake caliper by removing two bolts, securely wedge the pads in place, ensuring that this causes no spillage of hydraulic fluid from the reservoir in the front compartment, and hang-up the calipers. By using this method, no brake bleeding is needed when re-assembly takes place.
5. (This applies to rear wheel discs only). Remove the mechanical handbrake caliper, by undoing two bolts.
6. Loosen the two Posidriv screws, and ease the brake disc over the wheel dowel studs.

Re-assemble in reverse order, ensuring that the hydraulic (and where appropriate) mechanical handbrake calipers operate correctly. If fitting new discs, ensure that they are oil and grease free after assembly to the car.

 The skimming down of individual discs is not recommended as this will cause unequal braking during medium and heavy use.

Showing Rear Handbrake Caliper

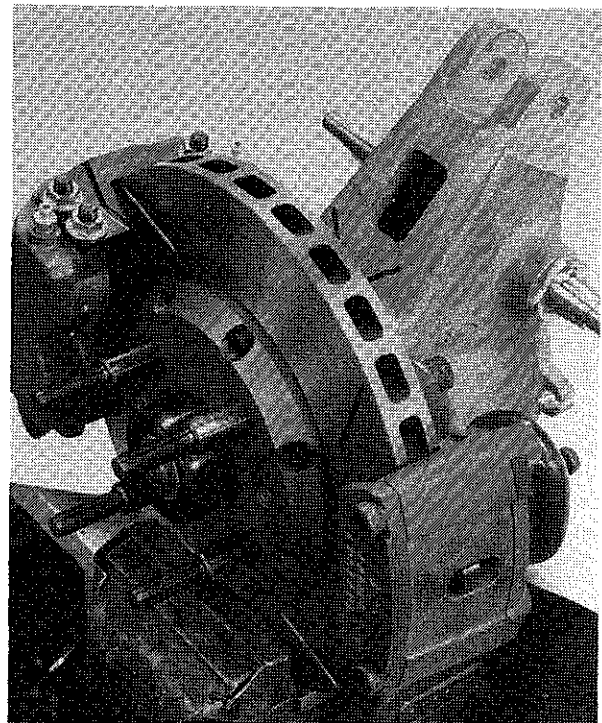
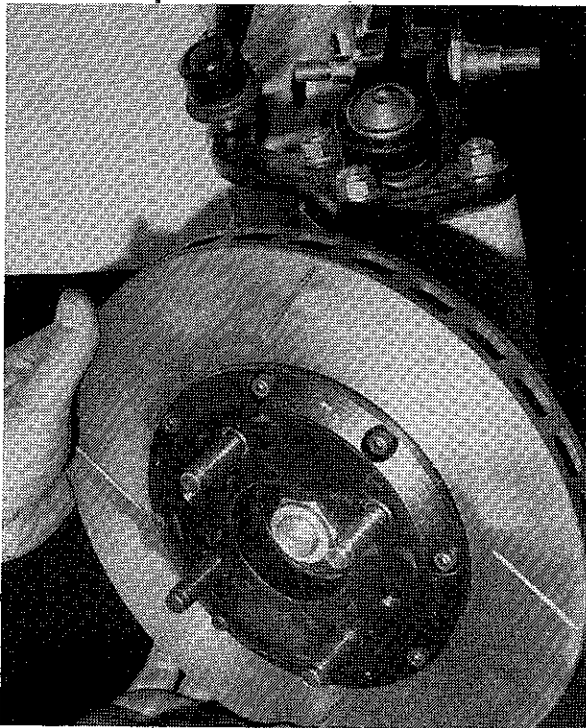

Handbrake lever

This is a standard FORD Sierra component, first used on 1983 model-year examples, and the assembly includes an electrical device, connected to a facia warning lamp, to warn the driver if the handbrake has been left in the ON condition.

Once the lever has been pulled up to apply the brake, and the button has been released, it stays in the ON position. To release the brake, hold the lever, pull it up slightly, depress the button, then push the lever down towards the transmission tunnel.

If it ever becomes necessary to *remove* the handbrake lever:

1. Raise the car on a ramp, or stands, chock the rear wheels, and fully release the handbrake. The lever should now be down, and parallel with the top of the tunnel.
2. Slacken off the primary cable adjuster, from underneath the car. This is located near the clutch bell housing. This releases the cable tension.
3. Peel back the carpet on each side of the handbrake gaiter, to expose the screws holding down the leather, and rubber, gaiters. Remove the six screws, and remove the gaiters.
4. Disconnect the handbrake warning light switch connector, and tape up the wires, so that they are not later mislaid, or damaged.
5. Undo the two handbrake retaining bolts, which fix the lever assembly to the transmission tunnel.
6. Lift the handbrake sufficiently to allow access, from above, to the primary cable fixing, ensuring that the inner cable does not become kinked.
7. Remove the clevis pin. This frees the cable from the lever.
8. Remove the handbrake lever from the car.
9. Remove the handbrake warning lamp switch, if a substitute handbrake lever is to be used.

Re-assemble in reverse sequence. Before driving the car, re-adjust the tension of the primary cable, to take up any slack in handbrake actuation.

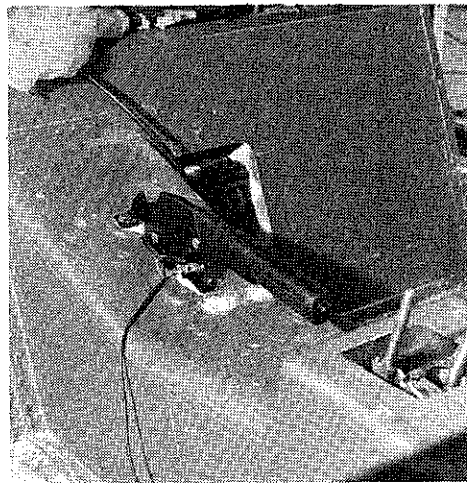

Primary handbrake cable

This connects the handbrake lever, which is positioned between the seats, to the quadrant, where the secondary handbrake cable is attached.

Removal:

Access to this part is from underneath the car.

1. Slacken off the primary cable adjuster, which is located on the cable, close to the clutch bell housing. This releases cable tension.
2. Remove the quadrant retaining clip, and slide the quadrant away from the chassis fixing.
3. Remove the clevis pin from the primary cable clevis, and withdraw the abutment from the bracket.
4. Remove the clevis pin from the handbrake lever, and withdraw the cable.

Re-assemble in the reverse order, then re-set cable tension (so that handbrake operates with handbrake lever in the correct attitude). Set the quadrant position – see illustration.

 The cable assembly must run between the radiator pipe and the tunnel side, to ensure that it does not foul the adjacent drive shaft.

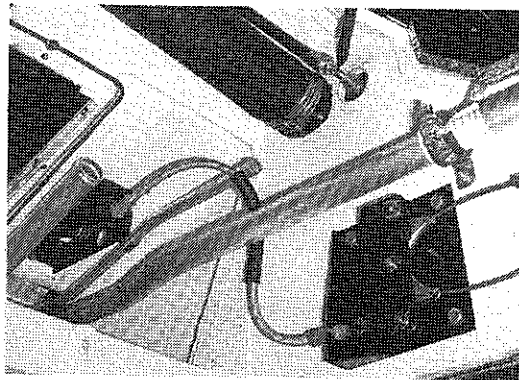

Secondary handbrake cable

This connects the handbrake calipers to each other, and is linked to the primary cable at the quadrant.

Removal:

Access is from the underside of the car.

1. Ensure that the handbrake is in the 'OFF' position.
2. Slacken off the cable adjuster, which is located on the chassis, ahead of the rear final drive flange.
3. Remove the quadrant retaining clip, and slide the quadrant away from the chassis fixing.
4. Remove the clevis pin from the 'horseshoe', remove the 'horseshoe' from the quadrant, and unhook the cable abutments.
5. Unclip the handbrake cables from their chassis fixings.
6. Remove the clevis pin, and clevis, from the handbrake calipers at each rear wheel hub.
7. Unhook abutments, and withdraw the cable.

Re-assemble in reverse order, ensuring that the handbrake calipers are correctly re-adjusted.

WWW.RS200.ORG

Upgrading for serious motorsport - the brake system

Where the RS200 is fitted with a rally-tuned engine, it may be necessary to provide enhanced braking performance. It is intended to offer a range of fittings, which should be fitted together. Refer to the Optional Motorsport Parts section.

WWW.RS200.ORG

FUEL SYSTEM

Index

	Page Nos.
Fuel tanks	81
Fuel pumps and filters	82

WWW.RS200.ORG

Fuel tanks

The standard RS200 is fitted with two aluminium alloy fuel tanks, which have one filler cap and neck, but which are fitted with balance pipes to allow speedy filling.

The filler cap is located on the left side of the car, immediately behind the passenger door, and has a lockable cap.

The left side tank, behind the left side seat, has a capacity of 30 litres/6.6 Imperial gallons. The right side tank, behind the right side seat, has a capacity of 60 litres/13.2 Imperial gallons. Total capacity is 90 litres/23.1 Imperial gallons. Note that the fuel contents gauge, on the instrument panel, measures the total contents of both fuel tanks.

Both tanks are fitted to the chassis/monocoque by being offered up from underneath, and are held securely in place by rubber padding above them, and by the closing plates in the floor of the vehicle itself.

Before attempting to remove either tank, it is important to realise that there are two cross-over connecting pipes – a large diameter balance pipe across the car, over the top of the engine's clutch bell housing, and a small-diameter pipe under that housing. Both must be disconnected before disassembly begins.

A suitable fire extinguisher should always be on hand.

! Normal 'No Smoking' or 'Naked Flame' precautions should be taken when working on the fuel system.

To remove either tank:

This work is best done over a pit, or on a ramp, to allow the bulky tank to be removed downwards.

1. Completely drain the fuel system, using the engine's electrical pumps to hasten the process.
2. (Left side tank only). Disconnect the filler neck from the left side tank, by unscrewing the appropriate connectors.
3. Bung the orifice exposed, to ensure that no dirt, or foreign matter, enters the tank while it is being removed.
4. Remove the cross cover over the upper, large diameter, flexible balance pipe, then disconnect and remove the balance pipe itself. Remove breather pipe and union, and bung the orifice.
5. Unscrew the tank connector exposed by removing this flexible pipe, and bung the orifice exposed.
6. (Left side tank only). Detach the fuel feed pipe to the low pressure fuel pump, and cover the exposed hole into the tank, with tape. Plug the feed pipe and tank connection to the fuel pump.
7. Carefully remove all the fixings which hold the tank support closing plate under the chassis/monocoque. As the final fixings are removed, support the plate (and the weight of the empty fuel tank) so that it does not suddenly fall down.
8. Remove the closing plate, but do not allow the tank to drop down at this stage.
9. Disconnect the small diameter cross-feed balance pipe connection and cover the exposed holes.
– The tank is now free to be withdrawn downwards.
10. Gently withdraw the tank, making sure that the rubber support angles are not damaged, and remain in place. Then disconnect the electrical wiring to the tank sender unit, and tape the wires out of the way.

– While the tank is out of the car, inspect the tank location cavity to ensure that there is no foreign matter trapped inside. Renew, or supplement, any of the support padding, as necessary.

Re-assemble in reverse sequence.

! If a new tank sender unit is fitted, ensure that the 'transport' float locking pin and tape are removed.

Note: Before using the car again, insert some fuel into the system, and check that there are no leaks from any of the connections, and that the fuel contents gauge is still working (and reading) properly.

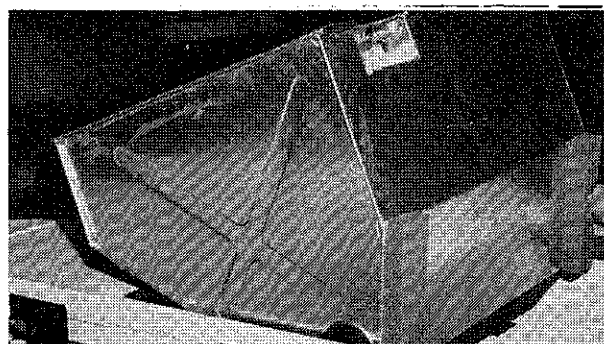
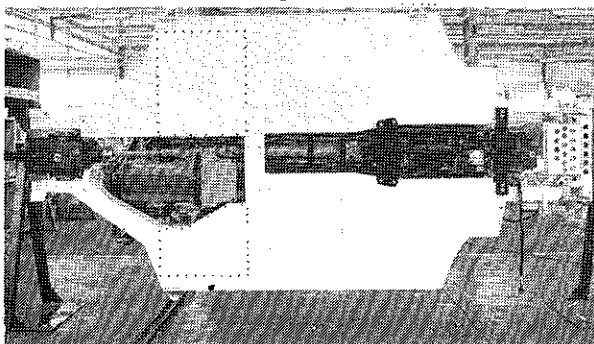

Upgrading for serious motorsport

It is intended that a kit of Premier foam-filled rubber bag tanks will be made available as an optional item.

See Optional Motorsport Parts section.

Fuel pumps and filters

The fuel pumps and filters of the RS200 are all grouped on the chassis/monocoque on the left side of the engine bay, behind the passenger bulkhead, and close to the filler neck to the fuel tanks.

The system works as follows:

Fuel is drawn from the fuel tanks by a low-pressure electric pump, which then delivers it to a swirl pot; by the nature of its design, this swirl pot is always kept full, so that air is not pumped into the fuel injection system.

There is a small fuel filter at the inlet end of the low-pressure pump.

From the swirl pot, fuel is piped to the high-pressure electric pump, which pushes it through an in-line fuel filter to the fuel injection system.

No normal maintenance is needed, apart from ensuring that the fuel filters are kept clean.

Note: Whenever any work is done on the fuel pumps, ensure that the electrical battery (situated low down, in the front of the car, between the chassis legs) is disconnected, and always have a suitable fire extinguisher to hand.

To remove filters:

Filter in the low-pressure pump

1. Disconnect the fuel feed pipe from the fuel tanks, and bung the end to prevent fuel from escaping, and to prevent contamination of any kind.
2. The coarse filter is at the inlet end of the low pressure pump. This may now be removed, cleaned out, and/or renewed..
3. After reconnection, check that there are no fuel leaks at the joints.

Separate Filter

This is a FORD component, found on fuel injection models such as the Granada and Sierra XR4i models, and is clamped to a bracket in the vicinity of the fuel pumps.

1. Disconnect the fuel feed pipe from the high-pressure pump, using an absorbent cloth to soak up any fuel which escapes, and plug the end of the pipe to ensure that the supply is kept clean and uncontaminated.
 2. Disconnect the fuel feed pipe to the fuel injection system, taking similar precautions.
 3. Loosen the clamp bracket screw sufficiently to allow the filter to be withdrawn from the bracket.
- Re-assemble in reverse sequence. After re-connection, check that there are no fuel leaks from the joints.

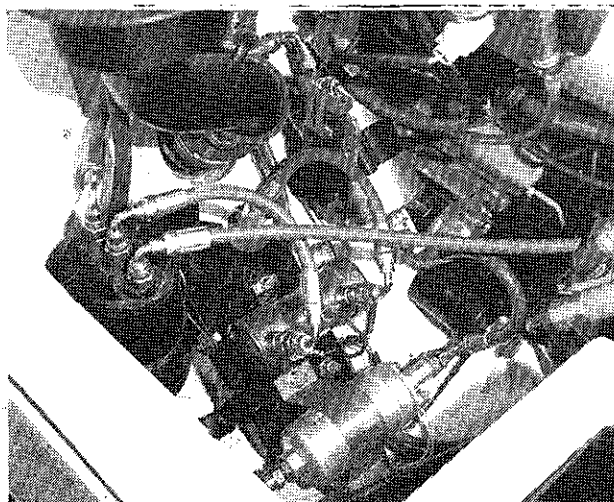

BODY SHELL AND PANELS

Index

	Page Nos.
Front body section	84
Front body apron	85
Rear body section	86
Passenger door	87
Door mechanism and fittings	88
Windscreen	89
Passenger compartment rear window	89
Seats	90
Safety belts	91
Instrument and facia panels	92
Paint repairs	93

WWW.RS200.ORG

FRONT BODY SECTION

Front body section

This large moulding is made from an advanced composite material and covers all the mechanical components ahead of the two-seater passenger cabin. It is a one-piece component, which also incorporates the inner front wheel arches, the exit ducting for the cooling radiator, and supports the headlamps and sidelamps.

It is hinged low down at the front, from the front body shell apron, and is latched by a lock fixed to the cross bar linking the front suspension spring pivots. This lock is unlatched by operating a lever which is positioned under the shroud of the steering column.

At regular intervals, make sure that the lock mechanism is still well greased, and that it continues to operate freely.

Removal

1. Unlatch the front section in the normal manner, by pulling down the red lever under the steering column shroud.
2. Lift up the body section, and stabilise it, in its over-centre position.
3. Disconnect the electrical battery leads. The battery is also in the nose of the car, mounted low between the front chassis extensions.
4. Disconnect the multi-plug electrical connections joining the headlamp/sidelamp, and the indicator side repeater lamps to the main loom.
5. At this point, and for the rest of the operation, have two helpers supporting the body section - one at each side.
6. Undo the front hinge pivot bolts - two each side.
7. Disconnect the over-centre safety catches, which are of FORD Fiesta type. These are placed at each side of the car, outboard of the radiator position. Care - these are spring loaded.
8. Lift off the bonnet, and store it carefully where its paintwork will not be damaged.

Caution: This operation should not be carried out, out of doors, in case gusting winds take command, and damage the body section.

Re-assemble in the reverse sequence.

Uprating for serious motorsport

Lightweight body sections are available for use in serious motorsport. See *Optional Ford Motorsport Parts* section.

Lubrication

When re-assembling the body section to the structure, clean and grease the locking catch, and grease the hinge pivots. Check, at regular intervals, that grease is still present in these locations.

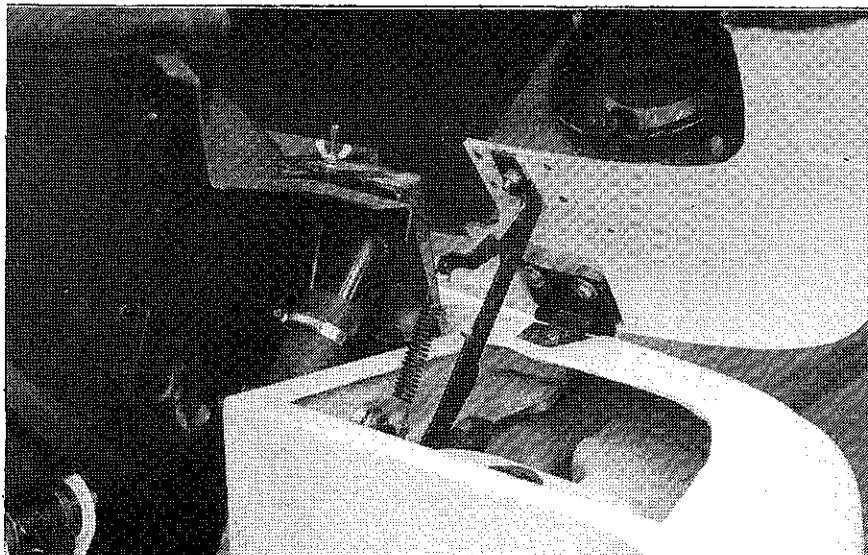

Front body apron

This is an advanced composite moulding, and acts as a cowling, and also a receptacle for the front turn indicator lamps, the twin fog lamps, the horns and the hinge supports for the front lift-up body section. It also surrounds, and channels cooling air, to the water cooling radiator and the oil cooler for the transmission.

It is fixed to the front of the body/chassis structure.

Apart from being regularly inspected, to look for stone chipping of the paintwork, or other minor accidental damage, no periodic maintenance is required.

Removal

1. Disconnect the electrical battery leads. The battery is in the nose of the car, mounted low between the front chassis extensions.
2. Remove the lift-up front body section (this is described elsewhere).
3. Disconnect all electrical wiring and withdraw the main loom, taking a careful note of the position of this wiring, for re-assembly purposes.
4. Disconnect water piping, and electrical wiring connections, from the windscreen-washer reservoir, mounted inside one of the side pods.
5. After noting the position of all spacers (where fitted), remove the six bolts (three each side of the car) which fix the apron to the radiator/body support frame.
6. With help, gently remove the apron forwards, and downwards, taking particular care to avoid contact with the radiator, transmission cooler, and cooling fan.

Re-assembly is in the reverse sequence.

Uprating for serious motorsport

Lightweight body sections are available for use in serious motorsport. See *Optional Ford Motorsport Parts* section.

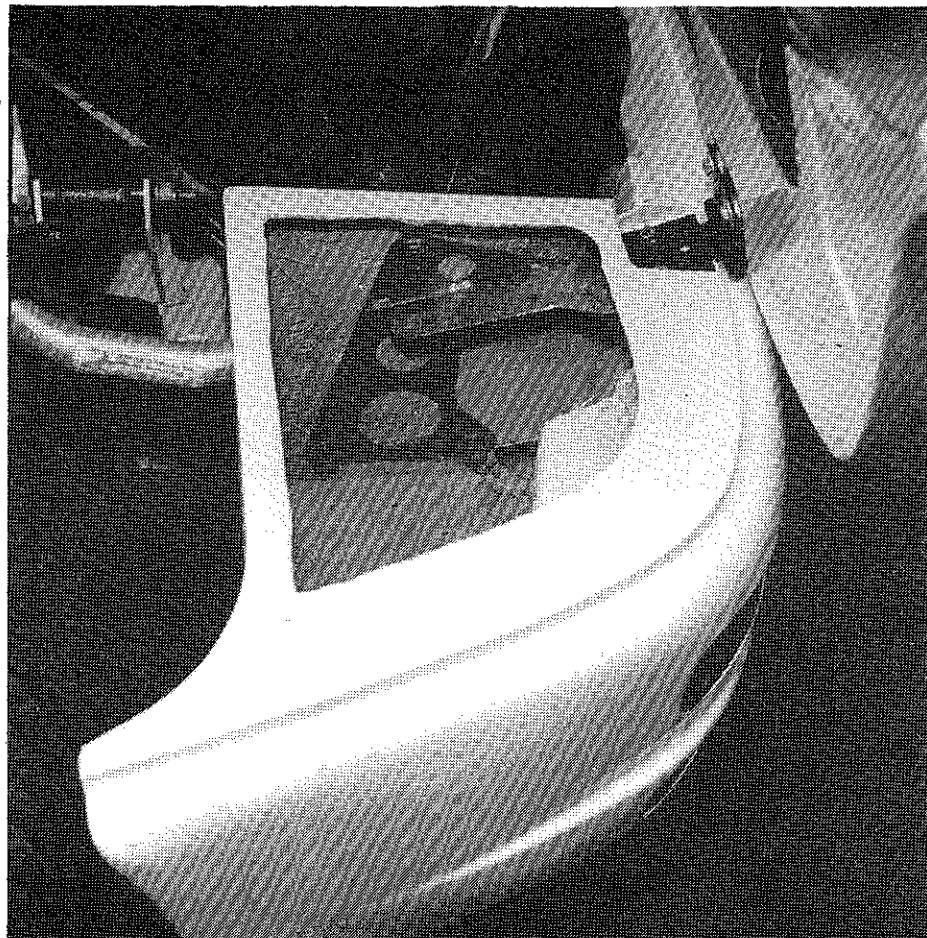

WWW.RS200.ORG

REAR BODY SECTION

This large moulding is made from advanced composite material and covers all the mechanical components behind the two-seater passenger cabin. It is a one piece component, which also incorporates the inner rear wheel arches, covers the spare wheel mounting position, and supports the tail/turn indicator/reverse lamp cluster, along with the rear number plate position, and the lights for that plate.

It is hinged at the front, from the top rear of the passenger compartment roof, and is latched by a lock in the tail fixed to the rearmost tubular chassis extension. This lock is unlatched by operating a lever, which is positioned internally, behind the left side seat.

As the lock is in a position in the tail where dust may swirl, make regular checks that the lock is kept well greased, and operates freely.

Removal:

1. Disconnect the electrical battery leads. The battery is situated in the nose of the car, mounted low between the front chassis extensions.
2. Unlatch the body section, by operating the pull lever in the passenger compartment, behind the left-side passenger seat.
3. Disconnect the multi-plug electrical connection which links the tail lamps and number plate lamps to the main loom. This is located near the left hand hinge.
4. Raise the body section, and prop it into the open position.
5. Disconnect both the gas-filled struts (which assist the opening of the body section) at the body end. – From this point, two people are needed to support and manoeuvre the body section.
6. Lower the section near to the closed position, but do not allow the locking catch to operate.
7. Remove the two hinge pivot bolts, which are situated above the rear of the passenger compartment roof, at each side of the intercooler position.
8. Lift the rear body section upwards and backwards to remove it from the car.
9. When putting the section down on the ground, rest it on rags, rather than hard ground.

Caution: This operation should not be carried out, out of doors, in case winds take command, and damage the body section.

Re-assemble in the reverse sequence.

Upgrading for serious motorsport

Lightweight body sections are available for use in serious motorsport. See *Optional Ford Motorsport Parts* section.

Lubrication

When re-assembling the body section to the structure, clean and grease the locking catch at the extreme tail. Make sure the gas-filled struts operate smoothly, and keep their spindles clean. Grease the hinge pivot bolts when re-assembling, and at regular intervals check that lubricant is still present.

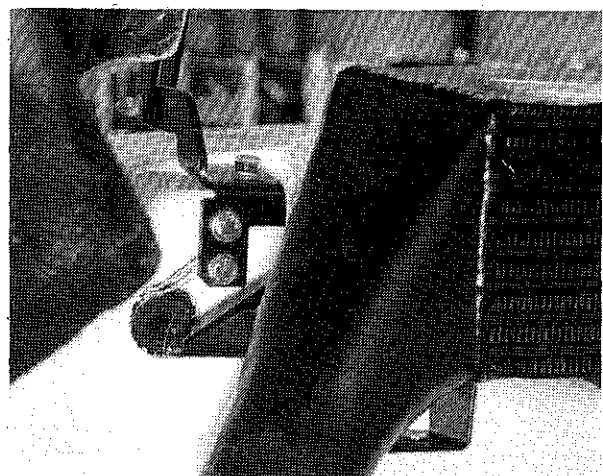
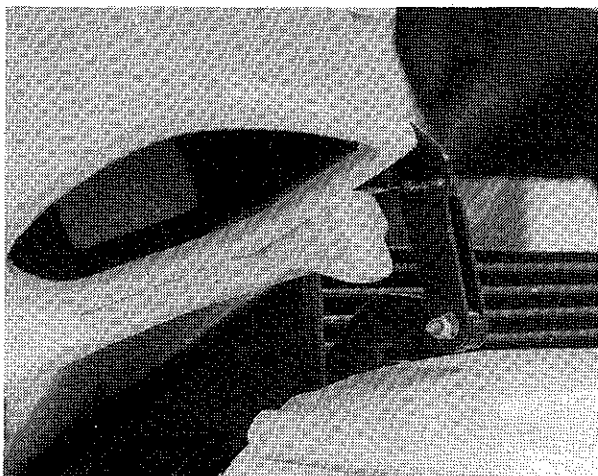

PASSENGER DOOR

Although, superficially, the door style resembles that of a Ford Sierra model, and uses much of that model's internal componentry, locks, and handles, the structure is a lightweight composite material. The door has two hinges at the front.

At regular intervals, see that the hinges, and the door locks, are properly lubricated, and check that the door seals (which prevent water and dust from entering the passenger compartment) are intact.

Removal:

1. Unlock and unlatch the front body section, lift it and prop it open. This gives complete access to the door hinges.
2. Open the door, and undo the bolt holding the check strap to the door pillar.
3. Wind down the window in the door (this will make it easier to hold the door in the operations which follow), then close the door again.
4. After carefully noting the position of any spacers, undo the four nuts (two per hinge) holding the hinges to the door pillar.
5. Unlatch the door, and – with help – gently support it, and ease it away from the body aperture.

Note: When storing the door, protect its sharp edges, the glass and the rear-view mirrors, from accidental damage.

Re-assemble in reverse sequence, making sure that the hinges are well greased, and that the spacers are re-placed in their correct positions.

Upgrading for serious motorsport

Lightweight doors are available for use in serious motorsport. See *Optional Ford Motorsport Parts* section.

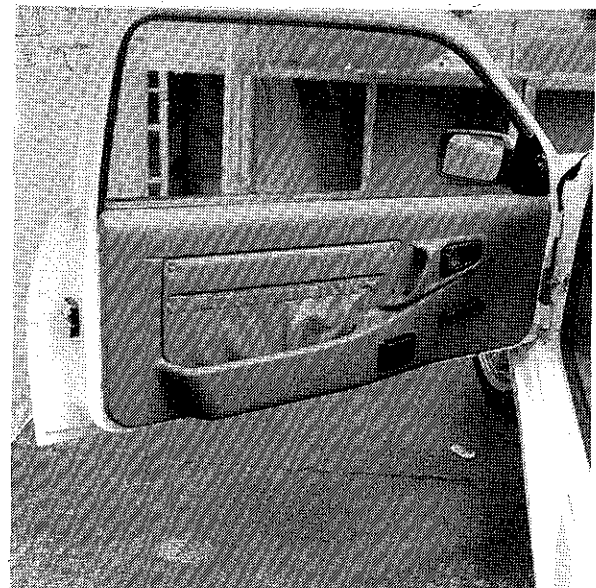
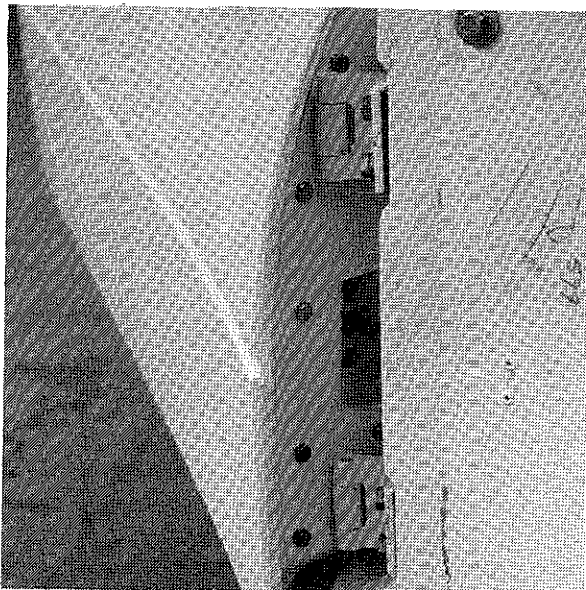

DOOR MECHANISM AND FITTINGS

Each door assembly of the RS200 uses many FORD Sierra front door components and fittings. Refer to the Complete Parts List for details of part numbers and Finis codes.

The door glass may be manually wound down by means of the handle near the front of the door. The internal locking button for the door is in the combined handle/door pull area. There is remote control adjustment for the exterior door mirror, by the joy stick at the front corner of the door.

To remove the door trim panel:

1. Remove the window wind-down regulator handle.
2. Remove the remote control handle assembly shroud.
3. Remove the trim panel-to-door fixing screws around the edge, and the other fixings to door components.
4. The panel may now be removed, and this exposes the remote control handle assembly and the remainder of the door mechanism.

Re-assemble in reverse sequence, replacing any clips which may have been damaged in the removal operation.

Removal of door locks and latches

This procedure is as fully described in the FORD Sierra Workshop Manual, pages 41/3, 41/13 to 41/17, and 42/5.

Removal of door window glass:

1. Remove the door trim panel, as described above.
2. Unscrew the remote control door mirror operating bezel, and remove it.
3. Carefully prise off the door mirror inner cover trim, from the front edge, to release the clip, and remove the cover.
4. Remove one screw and unclip the door glass run extension.
5. Lower the window, by temporarily re-fitting the window winding handle, until the ball-and-socket joints connecting the window bracket to the regulator are visible through the inner door aperture. Separate the ball-and-socket joints, and lower the window to the bottom of the door.
6. Detach the silent channel from the window aperture, taking care not to damage the aluminium formers. Remove the glass from the exterior of the vehicle.

Re-assemble in reverse sequence.

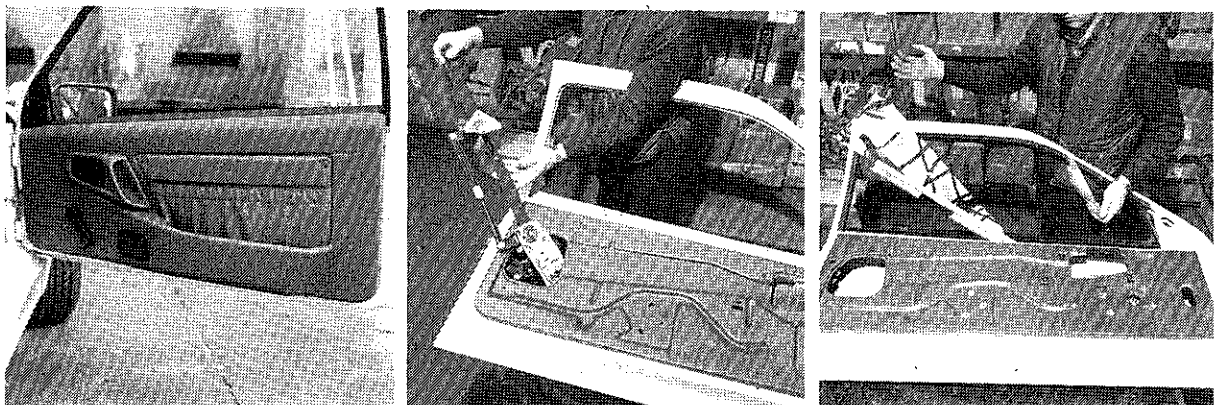

WINDSCREEN

The windscreen of the RS200 is made from laminated glass, and is a FORD Sierra 'aftermarket' component. (See the Complete Parts List for details). It is fixed to the body shell by way of a conventional rubber windscreen surround.

Removal, and installation of a replacement screen, should be carried out in the usual manner.

Upgrading for serious motorsport

For conditions of extreme cold, in rallying, it is intended to make a heated front windscreen available as an option. See *Optional Motorsport Parts* section.

Passenger compartment rear window

The rear window in the passenger compartment separates the occupants from the engine bay. Rear vision to the road is through this window, and through the Perspex cover in the top of the rear body section.

WWW.RS200.ORG

SEATS

SEATS

The RS200 is fitted with fixed-rake competition-style seats, which incorporate slots intended to accommodate full-harness safety belts, if these are fitted by the owner.

They have fore-and-aft adjustment only, and this is effected by moving the lever which is ahead of the seat frame to unlatch the mechanism, sliding the seat to its desired position, then locking the mechanism once again.

After doing this, check that the seat slide lock has properly re-engaged.

Removal:

The seat is fixed to the floor of the body/chassis structure by four bolts, through a frame.

1. Slide the seat all the way back. This exposes the front pair of bolt fixings, which should be removed.
2. Now slide the seat all the way forward. This exposes the rear pair of bolt fixings, which should be removed.
3. The seat, complete with its frame, can now be lifted clear of the shell.

Re-assemble in the reverse sequence, double checking the tightness of the fixing bolts after completing the operation.

Uprating for serious motorsport

To facilitate speedy access to the transmission, it is proposed to offer a quick-release seat runner kit. See *Optional Motorsport Parts*.

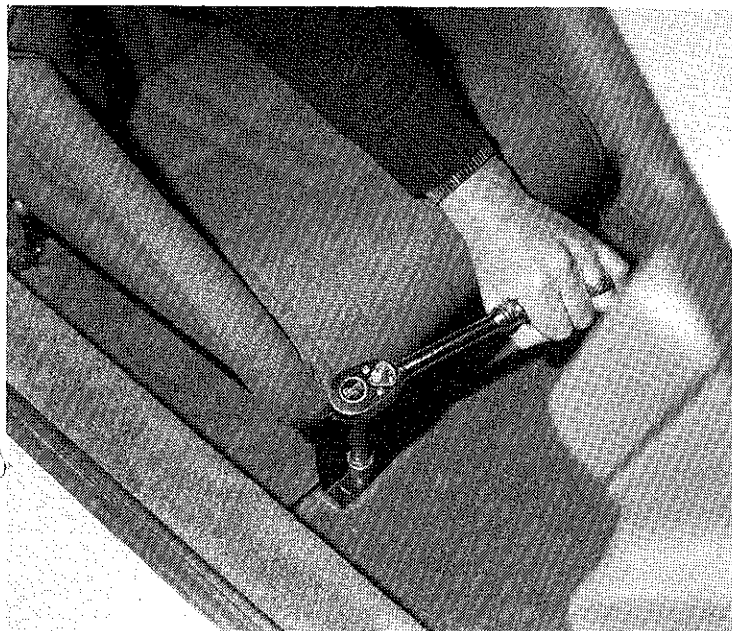

WWW.RS200.ORG

SAFETY BELTS

The RS200 is fitted with conventional three-point fixing, inertia-reel safety belts. In this installation, the inertia reel itself is mounted behind, and outboard of the seat, the shoulder pivot is from the safety roll cage above it, and the lower outer pivot is on the sill outboard of the base of the seat. The safety belt stalk, with standard FORD type of buckle, is mounted on the flank of the transmission tunnel.

If the reel is correctly mounted, no routine service of this component is required. At regular intervals, however, check that the locking mechanism is working correctly (a sharp tug on the webbing should cause the reel to lock at once), and that the retraction operation is firm and progressive.

Removal:

Although the belt may be removed without disturbing the seat itself, access to the lower mountings is much easier with the seat out of the way. Accordingly:

1. Remove the seat by undoing the four mounting bolts holding the frame to the floor.
2. If necessary, remove the inner fixed-length stalk, carefully noting, and preserving, the sequence of washers, and spacers, on the fixing.
3. Remove the lower outer fixing bolt, once again noting and preserving the sequence of washers and spacers.
4. Unclip the plastic moulding over the shoulder pivot, and remove the fixing bolt, preserving and noting the sequence of washers and spacers.
5. Unfasten the inertia reel from its mounting on the rear bulkhead. The belt assembly may now be removed from the car.

Re-assemble in reverse sequence.

Important: After the vehicle has been involved in an accident, in which the belts have come under severe strain, they should be discarded, and new belt assemblies should be fitted. This is necessary because the webbing may have been stretched beyond its useful limits during the impact.

Upgrading for serious motorsport

RS200 owners intending to use their cars in motor sports events will want to fit specialised full-harness belts.

For advice on such belts, and on fixing positions, consult the *Ford Motorsport Parts Division*.

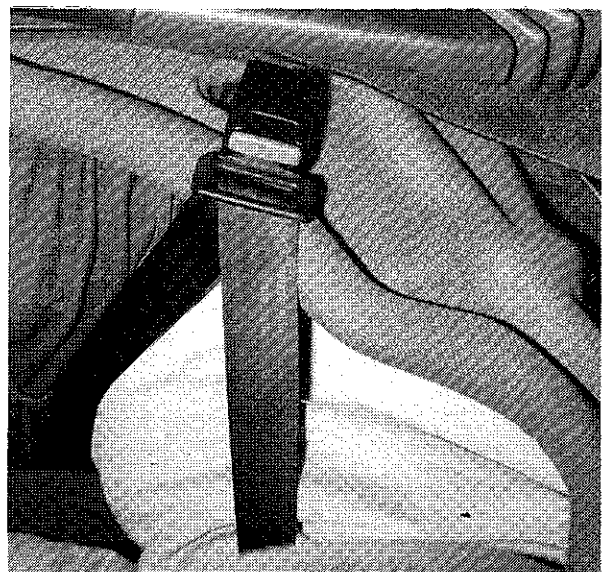
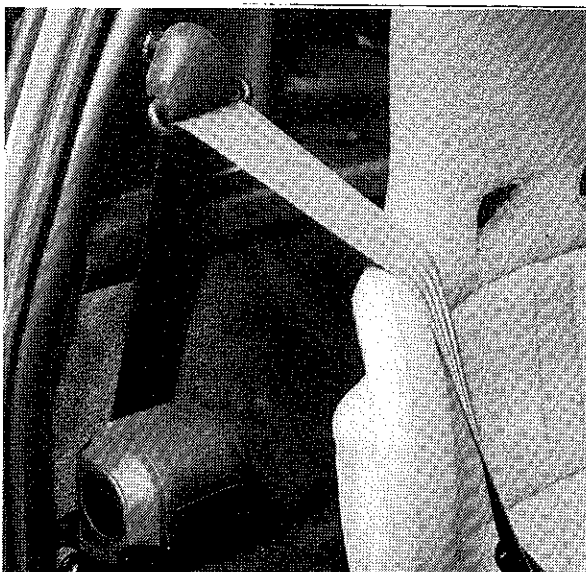

INSTRUMENT AND FACIA PANELS

INSTRUMENT AND FACIA PANELS

If it becomes necessary to remove any of the panels on the facia, to allow access to the electrical wiring, the fuse-relay box, or to the instruments and controls themselves, proceed as follows:

Driver's Instrument Console

1. If you intend to make changes to the electrical wiring, first disconnect the battery.
2. Remove the five self-tapping screws (four at the extremities of the panel, one close to the steering column cowl) which secure the panel to the main facia moulding after removing the black trim insert which is retained by self adhesive pads.
3. Gently withdraw the panel into the car, as far as required, taking care not to over-stretch, or break, the electrical wiring and the speedometer drive cable.

Stowage Compartment (facing the passenger)

This need only be removed, if it is desired to gain access to the main electrical fuses and relays, whose box is positioned on the bulkhead ahead of the stowage compartment moulding.

1. Locate and remove the two self-tapping screws which are under the bottom flange of the stowage compartment and the one at the top.
2. The compartment itself may now be unhooked from the main facia moulding, and removed, allowing easy access to the fuse/relay box.

Instrument Panel, Centre Console

This supports four auxiliary gauges, the heating and ventilation controls, eight electrical switches, and the blanking plate covering space for the radio installation.

The four instrument gauges are mounted on a separate bezel, fixed to the centre console by four self-tapping screws. This bezel, therefore, may be removed without disturbing the console itself.

The heater blower fan switch, similarly, is mounted to the centre console by two self-tapping screws, and may be withdrawn without disturbing the console itself.

The bank of switches is also located by its own separate bezel, which is held in place by two self-tapping screws, and two tags on its upper edge. This bezel may be withdrawn without disturbing the console itself.

If it is necessary to remove the main console moulding, it is affixed to the main facia moulding by four self-tapping screws. Two of these are near the bottom of the moulding, under the line of the switches, and each one is aligned, pointing sideways, close to the edges of the separate instrument gauge bezel. Once these have been removed, the entire moulding may gently be removed into the passenger compartment.

In each case, re-assembly is in reverse sequence.

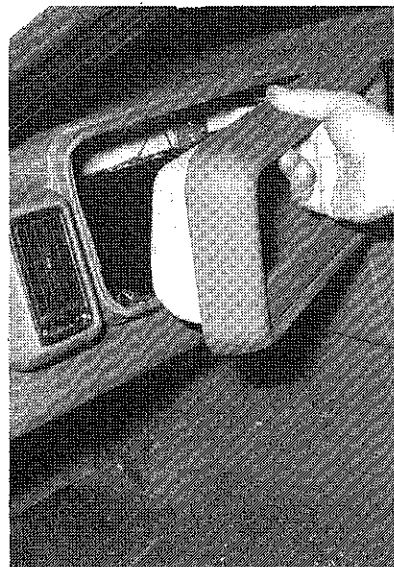

PAINT REPAIRS

As stated elsewhere in this publication, the RS200 is painted in FORD Diamond White, coded XSC 691. If ever it becomes necessary to respray a part, or all, of the body shell, it is essential to remember that several major body sections of this car are built from an advanced composite material, containing Glass Reinforced Plastic (Glassfibre); this means that under no circumstances should the car be baked in an oven after spraying, for this process will make those panels distort. If it is ever necessary to strip body sections back to bare material, it is recommended that a spray filler should be used before the priming and painting process begins.

WWW.RS200.ORG

ELECTRICAL EQUIPMENT

Index

	Page Nos.
Windscreen wiper motor and linkage	95
Windscreen washer installation	96
Battery	97
Horns	98
Headlamp/sidelamp units	99
Fog lamps	100
Indicator assembly, front	100
Indicator repeater lamp, side	101
Rear lamp/turn indicator, cluster	102
Steering column switchgear	103
Instruments, gauges, switches on facias	104
Interior lamps, front and rear	105
Electronic Engine Management System	106
Starter motor	107
Alternator	108
Distributor	109
Radio installation	110

WWW.RS200.ORG

ELECTRICAL EQUIPMENT

Windscreen wiper motor and linkage

This is a FORD Sierra component, and has a normal speed wipe, a high speed wipe, and a variable-speed intermittent wipe facility.

The entire installation – wiper motor, linkage, and wiper blade spindles – is based on that of the Sierra, and there are important installation differences between Left Hand Drive, and Right Hand Drive models.

To remove the wiper motor:

The following applies to *LHD cars only*:

1. Remove card cover centre panel.
2. Operate the wiper motor, so that the linkage is positioned to give access to Nut 'B' in the centre of the mounting.
3. Switch OFF the ignition switch, and disconnect the battery.
4. Remove Nut 'B' securing the wiper linkage to the motor spindle.
5. Remove the three securing bolts 'A', detach the motor from the bracket, and disconnect the electrical multi-plug.

For *RHD cars*, it is first necessary to *remove the linkage*, to allow access to the motor itself:

Removing the wiper linkage:

1. Pull the cover to expose the wiper arm spindles, then remove nuts, washers, and wiper arms.
2. Remove the windscreen wiper plastic cowl, by disconnecting the windscreen washer feed pipes, removing one screw at each end of the cowl top panel. Then carefully remove eight screw covers in the cowl, loosen and remove the eight plastic screws which hold the cowl to the body shell, and remove the cowl top panel.
3. Remove the bolts securing the wiper linkage assembly to the bulkhead. Withdraw the wiper linkage, and (on right hand drive cars) the motor assembly from the vehicle.
4. On right hand drive cars only, remove the three bolts securing the motor to the linkage assembly, and the centre nut securing the motor to the linkage. The motor may now be separated from the linkage. Disconnect the electrical multi-plug to completely free the motor from the car.

Re-assemble in reverse sequence.

Recommended torque settings are:

Motor to linkage brackets – 5 to 6 Nm (3.7-4.7 lb.ft.)

Linkage nut to motor – 12 to 14 Nm (8.8-10.3 lb.ft.)

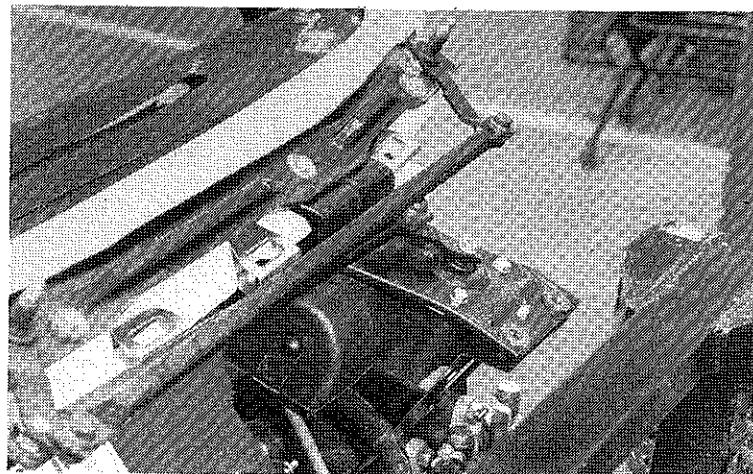

Windscreen washer installation

The windscreen washer reservoir is mounted low down, in the front body apron, on the right side of the car. There is an electrically driven pump, which supplies water under pressure to two nozzle positions at the base of the windscreen.

To remove the reservoir:

1. Drain or syphon any remaining water from the reservoir. Disconnect supply wires and hoses from the pump.
2. Undo and remove the reservoir retaining screws. Remove the reservoir from the front apron, and detach the pump.

To remove the nozzle from the windscreen surround:

[This is a standard FORD Sierra item, and procedure]

1. To unclip the nozzle, pull it forward (towards the nose of the car), disconnect the hose, and remove the nozzle from the car. It may be necessary to use a screw driver at the bottom slot of the front face. Re-assemble in reverse sequence, checking for leaks once the pipes, and the pump, have been re-connected.

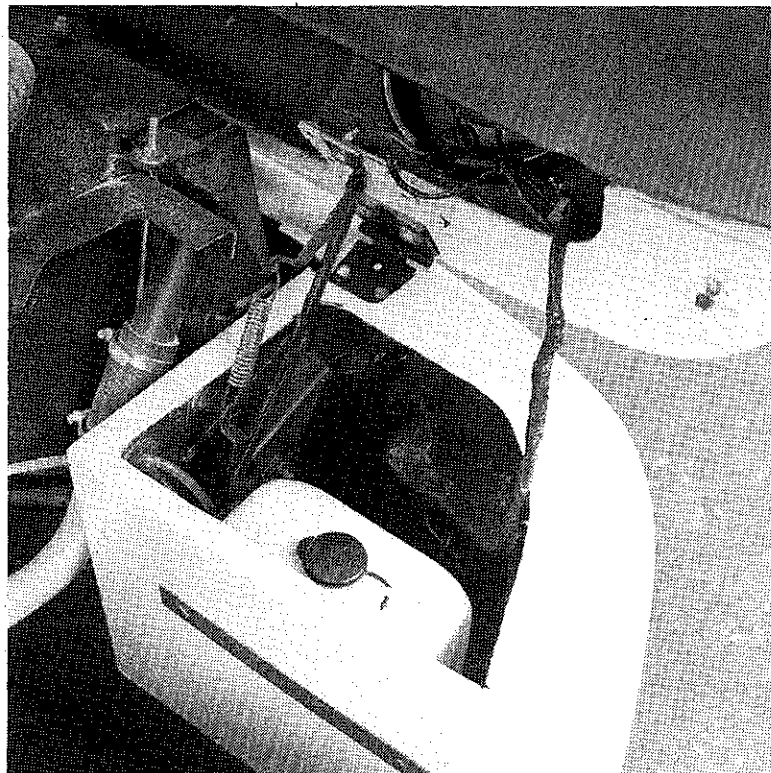

WWW.RS200.ORG

Battery

This is a standard 'No-Maintenance' Motorcraft 12-volt component, and is located in a cradle, low down, behind the chassis front cross-member.

It is not necessary to check its condition before 4 years of life, or 60,000 miles/100,000 km of use, under normal operating conditions.

At regular intervals, however, check the battery's general condition and charge, and be sure that the terminals are well-greased with petroleum jelly.

Typical battery voltage conditions, when checked, are:

12.5V	Poor condition
12.6V	Normal
12.7V +	Good

Removal

1. To make the lifting easier, unlatch and remove the lift-up front body section.
2. If the optional luggage stowage container is fitted to your car, this must also be removed from the chassis.
3. Undo, and remove the two retaining screws, one at each side of the battery, and lift off the retaining plate.
4. Remove the negative (black) earth connection *first*. Then remove the positive (red) cable connection.
5. Carefully withdraw the battery, upwards, being sure not to spill any battery acid.

Note: The cables should never be disconnected, or reconnected, when the car's engine is running.
Re-assemble in reverse order, connecting the red cable *first*.

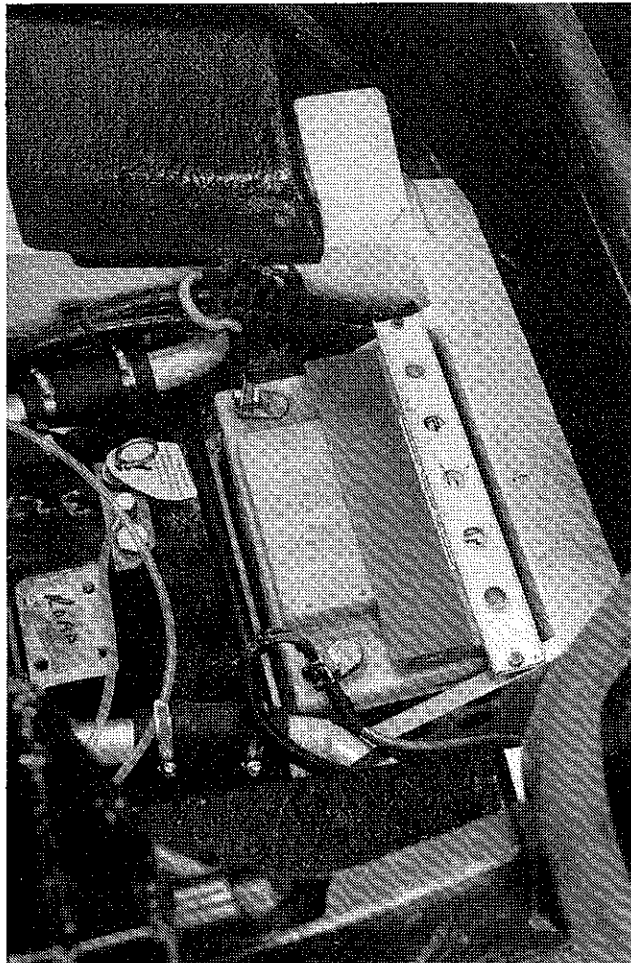

WWW.RS200.ORG

Horns

These are normal FORD Sierra High-Line units, and are located in the boxes of the front apron of the body shell, one to each side of the radiator/transmission oil cooler support bracketry.

To exchange horns, it is only necessary to raise the front body section, disconnect the battery, and remove two bolts from each horn support bracket.

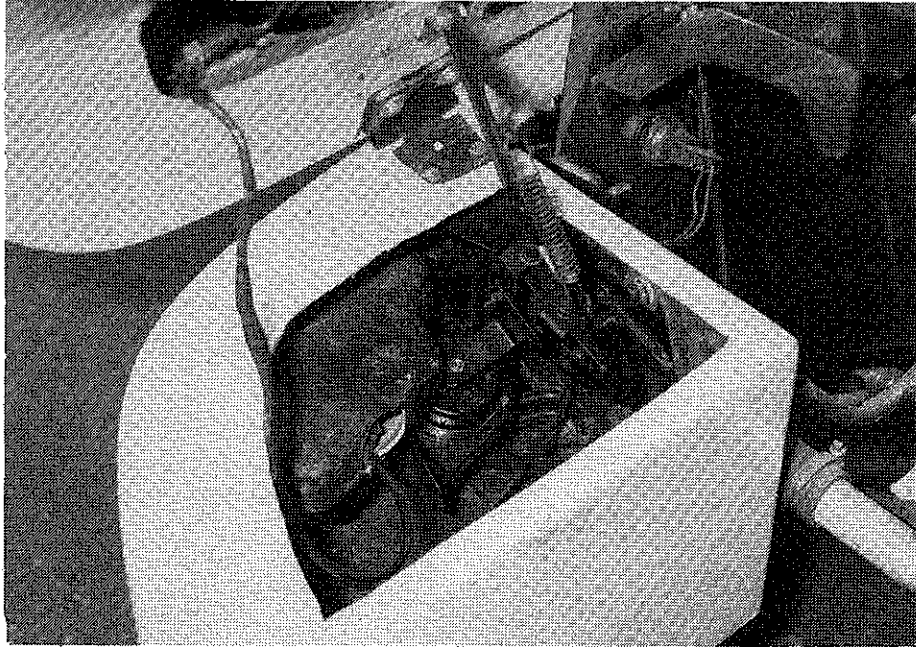

Front headlamp/sidelamp units

The RS200 is fitted with two circular headlamps, containing quartz-halogen bulbs, and the lens reflectors also incorporate positions for the side/parking lamps.

It is possible to exchange headlamp and side lamp bulbs from the inside of the front body section but it is most convenient to withdraw the headlamp unit from the body section before doing this. See Section 04-90.

Accordingly, to exchange bulbs, or to exchange headlamp units:

1. Remove the GRP headlamp bezel surrounding the headlamp unit, by taking out the self-tapping screws.
2. Undo three self-tapping screws which secure the headlamp clamping ring to the headlamp frame.
3. Withdraw the ring, forwards, out of the car. The headlamp reflector/lens unit may now be withdrawn, exposing the bulbs and wiring.
4. Disconnect the electrical wiring plug, and the unit may now be removed from the car.

To withdraw a headlamp bulb.

5. Release the bulb, by rotating the locating clamp anti-clockwise; the old bulb may now be removed from the reflector.

To withdraw a sidelamp bulb (which is in the side of the reflector):

6. Twist the sidelamp's plastic holder anti-clockwise. This allows the holder, and the bulb itself, to be withdrawn.

Re-assemble in reverse order.

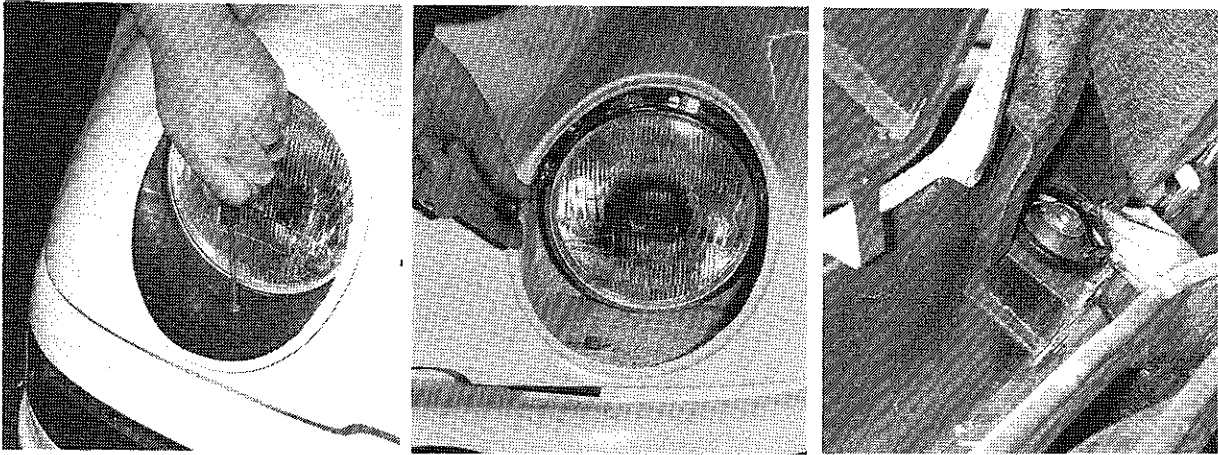

Note: Always hold the glass section of a new bulb with a clean cloth (to prevent finger contact). If the glass is touched, it should be wiped clean with methylated spirits.

Fog Lamps

Where fitted, a pair of Carello fog lamps are mounted low down, in the front body apron of the car. They are operated by a switch in the central instrument panel, and may be illuminated whenever the side lamps and/or the headlamps are in use.

The lamps are mounted vertically from the body apron itself, and their alignment may be adjusted by loosening the clamping load on the mounting nut and bolt. Access to the mounting bolt is best achieved by a box spanner through a hole in the apron's underside.

To remove the lamps:

1. Ensure that the lamps switch (which operates BOTH lamps) is OFF.
2. Undo and remove one slotted-head screw holding the lens clamping ring, supporting the ring as you do so.
3. Withdraw the clamping ring forwards, and the lens/reflector assembly may be withdrawn at the same time.
4. Disconnect the electrical connection to the main loom.
5. The clamping nut is now exposed, at the base of the lamp body.
6. Loosen and remove the bolt through the lamp's mounting spindle, supporting the lamp body as you do so.
7. The lamp may now be removed, forwards.

Re-assemble in the reverse sequence, making sure that no grit or foreign matter is trapped in the apron hole whilst this is being done. Adjust the alignment of the lamp before finally tightening up the mounting bolt.

Indicator Assembly, front

This is a standard FORD Sierra saloon component, first used on 1983 model-year cars.

Removal:

1. Push the lamp assembly rearward into its front body apron mounting, until the plastic tang is locked audibly into the depressed position. The indicator can now be extracted from the front of the car.
Disconnect the electrical loom plug.

Re-assembly:

1. Press the lever to release the locking tang on the indicator assembly.
Reconnect the loom plug, and refit assembly into front body apron, ensuring that the pivot locates into the slot, then push in to secure. Reconnect electrical connections.

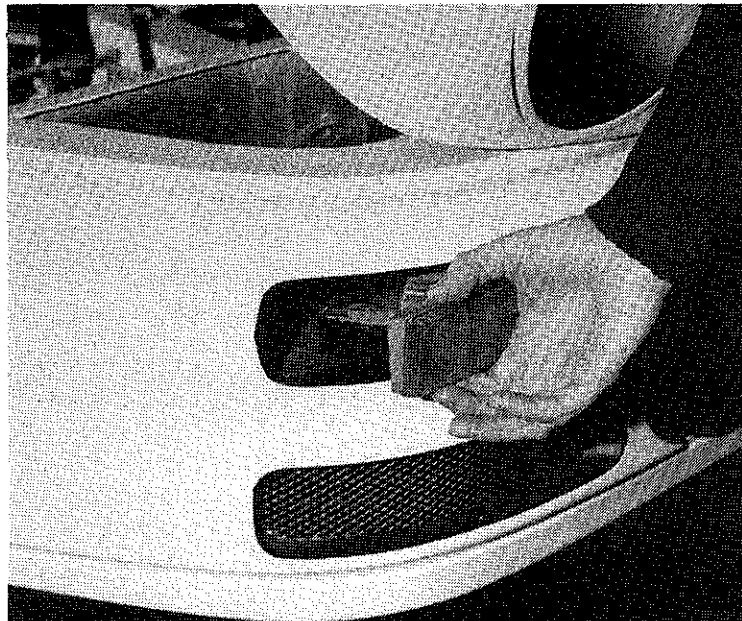

Indicator repeater lamp, side

This indicator is mounted in the front body section, behind the front wheel arch cut out. It flashes simultaneously with the front indicator. This is a standard FORD Sierra component, first used on 1983 model-year cars.

Removal:

1. Unlatch and raise the front body section. Access to the side repeater is now gained from inside the panel.
2. Depress the retainers, and withdraw the lamp unit from the body section. Twist the bulb holder, anti-clockwise, to remove it. The bulb is a push fit.

Re-assembly is in reverse order to the above.

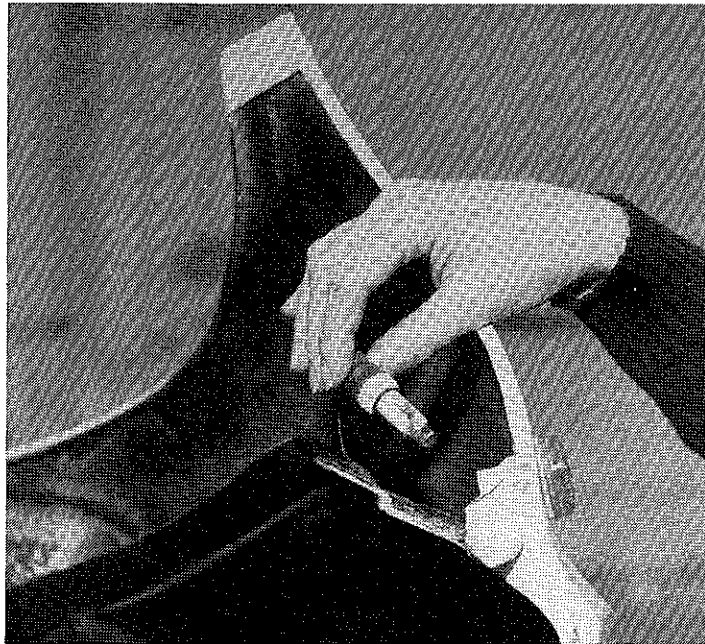

Rear lamp/turn indicator cluster

This is a standard FORD Sierra saloon component, first used on 1983 model-year cars. It incorporates the tail lamp, turn indicator lamp, reversing lamp, and high-intensity rear fog warning lamp.

Removal:

1. Unlatch the rear body section, raise it, and prop it securely. (Access to the lamp cluster is now gained from the inside of the raised rear section).
2. Remove the bulb holder assembly, at the same time disconnecting the multiplug.
3. Remove four nuts securing the lamp assembly, and remove the assembly from the body.

Re-assemble in the reverse order.



Steering column switchgear

This assembly is a standard FORD Sierra component, mounted to the FORD Sierra upper steering column, and first used on 1983 model-year cars.

Removal:

1. Remove steering wheel.
2. Unscrew retaining screws, and remove steering column upper and lower shrouds.
3. Remove two crosshead screws, and guide the multi-switch assembly away from the steering column.
4. Remove two crosshead screws, and guide the indicator switch assembly away from the steering column.
5. Disconnect the loom multiplugs (two each side) from the switch assemblies.
6. Disconnect the earth lead from the multi-switch assembly.
7. Both switch assemblies may now be removed from the car.

Reassembly is in the reverse order.

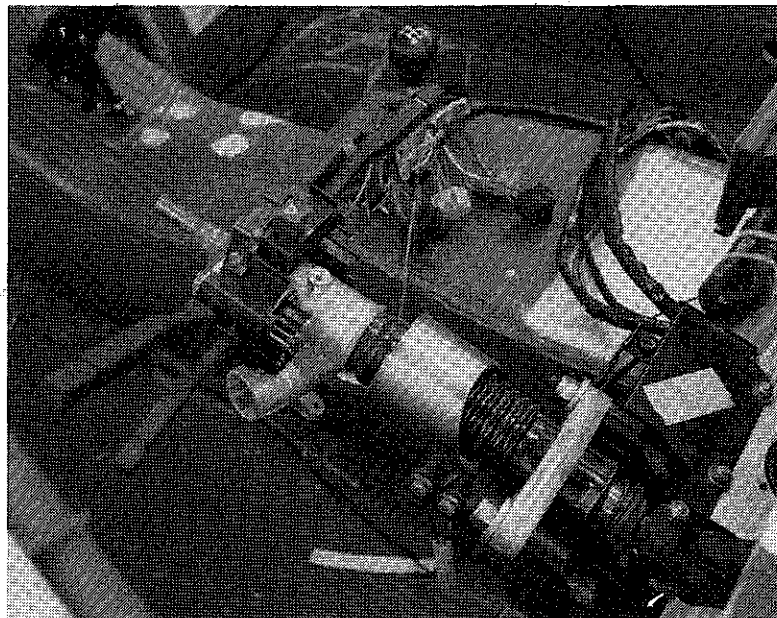

INSTRUMENTS, GAUGES AND SWITCHES ON FACIA

The layout of the facia, and the display of gauges and controls, is detailed in the KNOW YOUR CAR section of this Manual.

To gain access to the various components, and the electrical wiring to which they are connected, it is necessary to remove the appropriate panels:

To remove the driver's instrument console:

[This supports the speedometer, rev-counter, oil pressure and water temperature gauges, plus warning lights for brake system, oil pressure, ignition warning, main beam warning and indicator repeaters]

1. Disconnect the battery, to eliminate any danger of electrical short-circuits.
2. After removing the trim insert remove the five self-tapping screws (four at the corners of the panel, one close to the steering column cowl) which secure the panel to the main facia moulding.
3. Gently withdraw the panel into the car, as far as is necessary to gain access to the gauge or warning light in question, taking care not to over-stretch any electrical wires, or the speedometer drive cable.

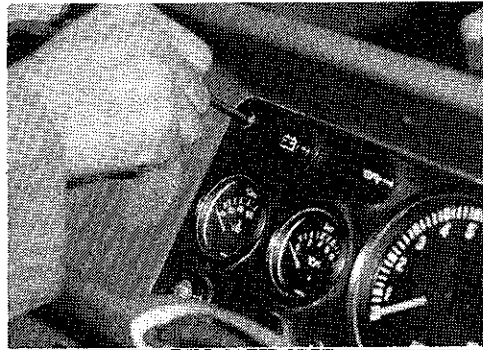

To remove the instrument panel, centre console:

[This supports the fuel contents, fuel pressure, voltmeter and turbocharger boost gauges, the heater controls and the heater fan motor control, switches for fog, auxiliary, and rear fog warning lamps, and a bank of four spare switches]

The four instrument gauges are mounted on a separate bezel. This may be removed by unscrewing four self-tapping screws, after which each gauge may be detached, as required after removing the trim insert. The heater blower fan switch is mounted to the centre console by two self-tapping screws, and may be withdrawn without disturbing the centre console itself.

The bank of switches is located by its own separate bezel, which is held in place on the console by two self-tapping screws, and two tags on its upper edge. This bezel may be withdrawn without disturbing the console itself.

To remove the main console, it is necessary to locate, and remove, four self-tapping screws. Two of these are near the bottom of the console, under the line of switches, and one each is aligned, pointing sideways, close to the edges of the separate instrument gauge bezel. Once these have been removed, the entire console moulding may gently be removed, into the passenger compartment.



Interior lamps – front and rear

One lamp is situated at the centre of the screen rail, and is close to the digital clock. A second lamp is situated at the rear of the passenger compartment, above and behind the passenger seats. Each lamp has a three position switch:

Light comes on automatically when a door is opened.

Off.

Light permanently illuminated.

– In the 'automatically illuminated' positions, both lamps are actuated by the opening of the same door.

To remove the lamps, to gain access to the bulb:

1. Ensure that the lamp switch is in its central, 'OFF' position.
2. Carefully insert a screwdriver into locating holes in the side, under the rim of the lamp, and gently prise the interior lamp assembly out of its aperture.
3. Unclip the bulb, and disconnect the wires. For the rear unit, detach the connections for the map lamps before removing the unit.

Swivelling map reading lamps (rear lighting console, only)

Two swivelling map reading lamps are provided, one at each side of the interior lamp in the rear-mounted console. These give an adjustable, directional, light, useful for studying maps, or other written material, at night. Each map reading lamp has its own individual switch mounted alongside.

To remove a map reading lamp:

1. Remove the interior lamp assembly, alongside, as described above.
2. Carefully prise out the map reading lamp, using a thin-edged screwdriver.
[Alternatively, the map reading lamp can be detached from the roof console by inserting a finger through the interior lamp slot, and pushing the map lamp body outwards from behind the panel.]
3. Disconnect the map lamp wires from the interior lamp, and remove the bulb.

Re-assemble in reverse sequence.

ELECTRONIC ENGINE MANAGEMENT SYSTEM COMPUTER

Like other modern FORDs, the RS200 is fitted with a FORD EEC IV Electronic Engine Management System. The computer which forms the central part of this installation is mounted on the rear passenger bulkhead, above and between the backrests of the passenger seats.

Two relays connected with this system are located in the wiring loom on the other side of the passenger bulkhead, but physically close to the computer itself.

No special service attention is required to this computer. Fault finding should be carried out in the same way as for the EEC IV installations in other EEC IV-equipped FORD cars.

Experience shows that most electrical problems are immediately blamed on the Engine Management System, but that the fault is invariably elsewhere, in the wiring, or with a component. Before deciding to remove the Management System itself, therefore, check and double check the components concerned.

If it is necessary to remove the Management System Module:

1. Disconnect the battery earth cable.
2. Loosen and remove one self-tapping screw holding the multiplug, and wiring loom, to the main body of the module.
3. Loosen the self-tapping screws securing the module to the rear passenger bulkhead. The module may now be removed from the car.

*Note: If it is necessary to recharge the battery, disconnect **both** positive and negative terminals of the battery, as otherwise the module will be destroyed.*

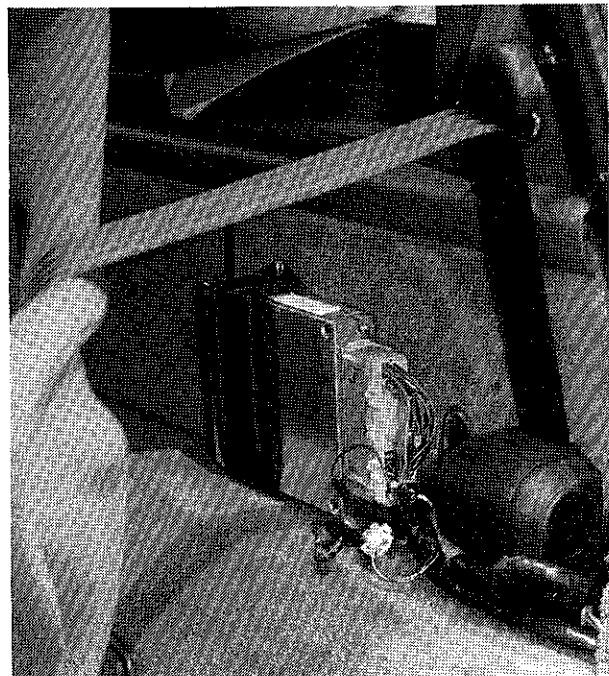
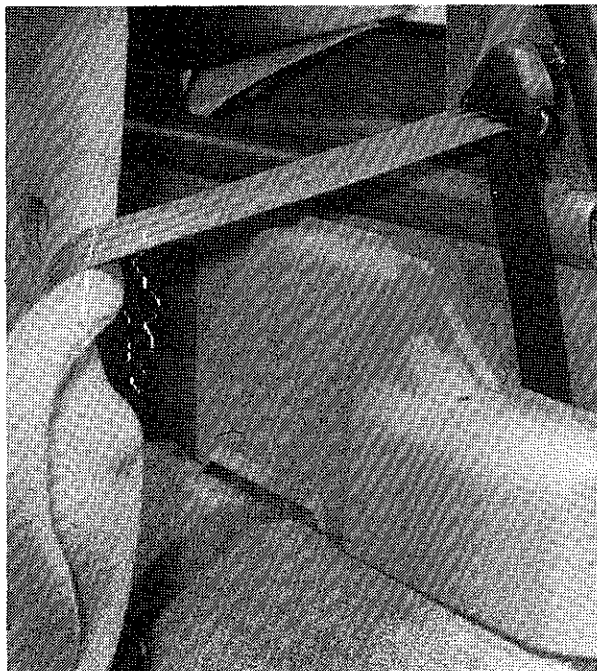

STARTER MOTOR

The starter motor is a Japanese Nippondenso unit, and is mounted on the inlet side of the engine, at the forward end of the engine as it is installed in the car. It operates by driving the starter ring, which is around the perimeter of the flywheel.

No normal maintenance is required, except to ensure that the moving parts are kept clean. Especially if the RS200 is habitually used in dusty or muddy conditions, the starter motor should be kept free of contamination.

Removal:

Note that access to the fixings of the starter motor is from above, *and* below, the car.

1. Unlatch and raise the rear body section. Prop it securely.
2. Jack up the rear end of the car, and use stands.
3. Disconnect the battery.
4. Remove the upper starter motor retaining bolt, from above.
5. Working from underneath the car, disconnect the electrical wiring.
6. Working from underneath, remove the lower starter motor retaining bolt.
7. Remove the starter motor, from the underside of the car.

Re-assembly is in the reverse order.

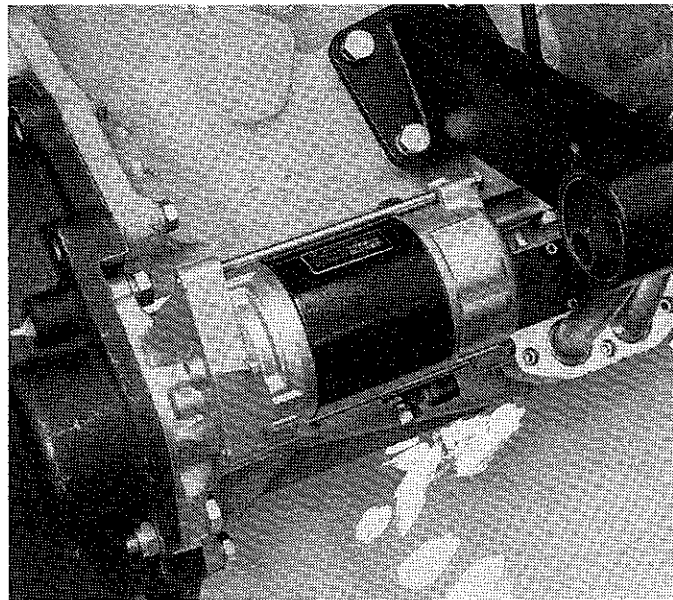

Engine alternator assembly

The alternator, which produces the electrical power to run the car's systems, and which keeps the main battery charged-up, is a 75 Ampere rating Lucas component, and is mounted on the inlet side of the engine, under the inlet manifold, and to the rear of the engine unit as installed in the car. It is driven by a multi-vee belt from a pulley on the end of the crankshaft; the same belt also drives the water pump pulley.

No normal maintenance is required, except to ensure that the moving parts are kept clean, and that the correct belt tension is maintained at all times.

Removal:

1. Disconnect the battery.
2. Remove the electrical connection from the rear of the alternator.
3. Slacken the long through-bolt fixing, on which the alternator pivots.
4. Disconnect the alternator adjusting strap from the alternator, taking a careful note of the clamp fixing layout.
5. Remove the alternator drive belt.
6. Undo the alternator mounting bracket (to sump) fixing screws.
7. Remove the alternator, complete with its mounting bracket from the engine.
8. On the workbench, transfer the mounting brackets to the replacement alternator.

Re-assembly is in the reverse order, ensuring that the adjusting strap clamp fixings are correctly positioned.

Finally, adjust the drive belt tension so that total free movement, laterally, measure on the longest belt span, should be approximately 10mm (0.4in.) applying normal fingertip pressure.

Upgrading for serious motorsport

Where a car is prepared for use in motorsport, with extra electrical equipment – lamps, electrically heated windscreen, and other fittings - a heavy-duty alternator is recommended.

It is intended to offer a 110 Amp alternator kit, complete with mounting brackets. See *Optional Motorsport Parts* section.

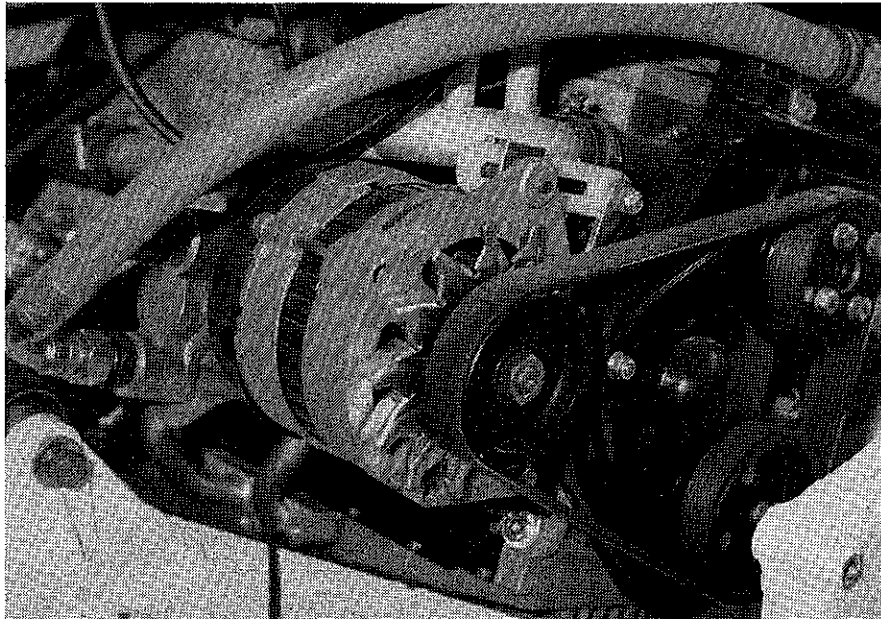

Distributor

This is a four-cylinder FORD unit, located on the inlet side of the engine cylinder block, affixed to the side of the cylinder block, under the inlet manifold itself.

It is driven by skew gears from the engine jackshaft, and has five High Tension cables fixed to its cap – one from the coil, and one each going to a sparking plug.

The engine timing may be adjusted by rotating the body of the distributor about its shaft. Because the RS200 has a FORD EEC IV Electronic Engine Management System, there is no make-and-break mechanism in the distributor body.

If it is necessary to change the distributor, it is recommended that this is done when the engine is cold – merely to obviate the possibility of the mechanic's hands being burnt on the hot castings.



Removal:

1. Ensure that the ignition switch is OFF, and the key removed.
2. Disconnect the battery.
3. Unlatch, lift, and prop the rear body section. Access to the distributor is gained from the inlet side of the engine.
4. Rotate the engine to the Top Dead Centre position on the compression stroke for No. 1 cylinder. This is ideally done by removing the engine's camshaft drive belt top cover, and seeing that the timing marks on the two camshaft pulleys are in alignment.
5. Remove the distributor cap. Note the marked position of the rotor arm to the distributor body at this juncture.
6. Set up the same relative alignment of rotor arm to distributor body on the new distributor.
7. Loosen and remove the bolt holding the distributor clamp plate to the cylinder block.
8. Withdraw the distributor and its drive shaft from the skew gear on the jackshaft, noting the direction of rotation of the distributor body as this is being done.
(When preparing to fit the new distributor set up its alignment to coincide with this).
9. Ensure that the O-ring on the distributor housing is not damaged, and replace it with a new ring if necessary.

Re-assemble in reverse sequence. Before closing up the engine front cover, check to ensure that the distributor is at its marked Top Dead Centre position when the two camshaft pulleys also indicate that the engine is at TDC.

Timing:

To adjust the spark timing, it is necessary to set up the spark to a nominal 10 degrees before Top Dead Centre, according to the following procedure:

1. Pull out the electrical plug, which is situated in the wiring loom close to the fuel pumps and the passenger bulkhead, on the engine bay side of that bulkhead. This converts the Electronic Engine Management System to what is known as the 'Limp Home' mode.
2. Remove the upper camshaft drive belt cover, thus exposing the camshaft drive pulleys, and their timing notches on the periphery.
3. Start up the engine, allow it to warm through, and for the idle speed to stabilise.
4. Slacken off the distributor locking ring, so that the timing may be adjusted if necessary.
5. Using the Top Dead Centre marks on the camshaft drive pulleys as a datum, and employing a suitable adjustable strobe timing light, re-set the position of the distributor so that the spark occurs at 10 degrees before TDC at this engine speed.
6. Lock up the distributor in its required position, and after doing so, once again check the timing. If necessary, repeat Operation No. 5.
7. Replace and refix the camshaft drive belt cover.
8. Replace the electric plug in the wiring loom close to the fuel pumps and the passenger bulkhead.

Radio installation, receiver, and aerial and aerial

No radio, cassette, or other form of In-Car Entertainment is fitted to the RS200 as standard.

Provision, however, has been made in the packaging of the design for suitable equipment to be fitted, and the standard H.T. Ignition leads are properly suppressed so that satisfactory radio reception may be achieved.

No basic radio wiring is included in the standard wiring loom.

Installation of the I.C.E., therefore, is left to the individual owner. The following basic advice is offered:

Receiver: Space for the standard-sized receiver has been provided behind the Instrument Panel Centre Console, and a blanking plate is positioned below the fresh air ventilation outlets, and above the bank of eight electrical switches.

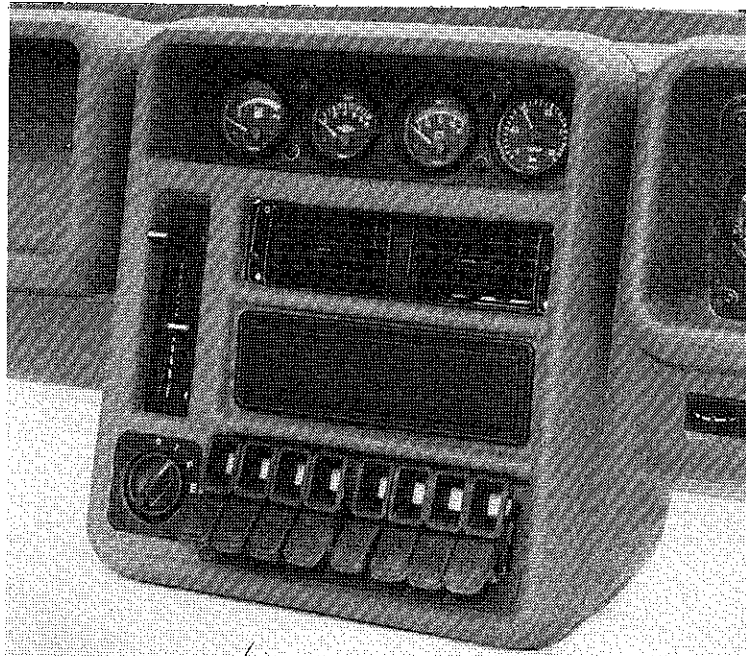

Aerial: Because of the way that the front body section hinges forward from the base of the windscreen, and because of the way the rear body section hinges up from pivots at the rear of the roof of the passenger cabin, there is no space for a conventional vertical aerial. It is suggested that a central roof aerial should be used. The roof section of the car as constructed of advanced composite materials. To improve radio reception, a cross of aluminium foil, has been laminated into the roof. To contact this cross, place the base of the aerial in the centre of the roof, 400 mm \pm 20 mm (15.75 in. \pm 0.75 in.) back from the edge of the windscreen aperture.

For electrical and earthing purposes, note that some sections of the RS200 chassis and body structure are in non-metallic materials, which do not conduct electricity.

CHASSIS DIMENSIONS

WWW.RS200.ORG

TIGHTENING TORQUES

WWW.RS200.ORG

RS200 TORQUE SETTINGS IN LBF/FT

INSPECTION ITEM	PART No.	DESCRIPTION	TORQUE	
Chassis Build Axle Mtg	E600420	2-M14 Bolt and Nyloc Nut-Axle to chassis	100-110	
	E600416	2-M12 Bolt-Axle to Axle Mtg Brkt		
Rear Driveshafts	MS180603-S72	4-M8 Screws D/S Assy to T/Box input shaft	23-25	
	304637-S80	4-3/8" UNF bolts D/S Assy to Centre Section	17-21	
	E400044-S80	4-3/8" UNF bolts D/S Assy RR to RR Diff	17-21	
	55674-ES80	4-3/8" UNF Locknut Assy RR to RR Diff	17-21	
	E600215-S72	4-M8 Bolts Centre Brg to Clutch Hsg	15-19	
	MS180613-S72	12-M10 Bolt Driveshaft to Diff	46-50	
	MS180613-S72	12-M10 Bolt Driveshaft to Spindle	46-50	
	Rear Suspension	MS180021-S72	2-M12 Bolt plt R/Susp Mtg F/Most to chassis	60-66
		MS182039-S72	2-M12 Locknut R/Susp Mtg F/Most to chassis	60-66
		MS180023-S72	2-M12 Bolt Brkt L/L Mtg to R/Susp Mtg plt R'most	60-66
MS180025-S72		2-M12 Bolt supp rear Top Wishbone Assy to Rr mounting frame rearward	60-66	
MS180027-S72		2-M12 Bolt support rear Top Wishbone Assy to rear mtg frame rearward	60-66	
E602209-S72		2-M10 Bolt support rear top Wishbone Assy to rear supp mtg plate rearward	33-37	
E626434-S72		2-Locknut M10 support rear top Wishbone Assy to rear supp mtg plate rearward	33-37	
MS182050-S72		2-M24 Locknut on rear spindles	171-189	
MS180625-S72		4-M12 Bolt caliper to upright	81-89	
E602230-S72		4-M12 Bolt H/Brake Caliper to upright	81-89	
MS182040-S72		2-M16 Locknut Assy rear upright lower stud	147-162	
MS172002-S72		1-3/4" UNF Thin nut wishbone rear upper	24-26	
MS180027-S72		2-M12 Bolt W/B Rear upper to rear upright	60-66	
MS182039-S72		2-M12 Locknut Rear upper to rear upright	60-66	
MS180030-S72		2-M12 Bolt supp Mtg Assy to Mtg plate r'ward	60-66	
MS182039-S72		2-M12 Locknut Mtg Assy to Mtg plate r'ward	60-66	
MS1820024-S72		2-M12 Bolt W/B Rear lower to chassis r'ward	60-66	
MS182039-S72	2-M12 Locknut Rear lower to chassis r'ward	60-66		
MS180024-S72	2-M12 Bolt W/B Rear lower to chassis f'ward	60-66		

RS200 TORQUE SETTINGS IN LBF/FT

INSPECTION ITEM	PART No.	DESCRIPTION	TORQUE
Front Suspension	H85PB 5497 AA	1 -7/8" UNF Nut rod end Brg R/H thread	91-99
	H85PB 5495 AA	1 -7/8" UNF Nut L/H thread rod end Brg	60-66
	MS180022-S72	2-M12 Bolt link lower to Brkt link lower	60-66
	MS182039-S72	2-M12 Locknut lower to Brkt link lower	6-8
	MS182032-S72	4-M6 Locknut clamp to Mtg plate rear most	15-19
	E620433-S72	2-Locknut bolt drop link	
	MS180621-S72	2-M12 Bolt Stay to Frame	85-93
	MS180029-S72	2-M12 Bolt to Frame Chassis	60-66
	MS182039-S72	2-M12 Locknut Frame to Chassis	60-66
	MS182039-S72	2-M12 Locknut Ball Joint to Steering Arm	60-66
	MS180625-S72	2-M22 Locknut Front Wheel Hub	M171-189
	MS182035-S72	2-M12 Bolt Caliper to Upright	81-89
	MS182035-S72	4-Locknut M10 Mounting Block to Upright	35-39
	MS180601-S72	3-M10 Locknut Assy Frt Upr to Strg Arm to Upright Assy	35-39
	MS182029-S72	5-M8 Socket Head Screw Front Brg	23-25
	E620436-S72	1-M18 Nut Arm W/bone Lower R'most to Rod End Brg	91-99
	MS182022-S72	2-M16 Locknut Block Assy to Lower Susp Arm	60-66
	MS180612-S72	2-M18 (twin) Nut Arm to End Fitting Locking	91-99
	MS180028-S72	4-M10 Bolt Upper Arm to Strut	48-52
	MS182039-S72	4-M12 Bolt Upper Wishbone to Chassis	60-66
MS182039-S72	4-M12 Locknut Upper Wishbone to Chassis	60-66	
MS180028-S72	2-M12 Locknut Lower Fr W/bone F'most to R'most	60-66	
MS182039-S72	2-M12 Bolt Lower W/bone to Foremost Chassis	60-66	
MS180027-S72	2-M12 Locknut W/bone to Foremost Chassis	60-66	
MS182032-S72	2-M12 Bolt Lower W/bone to Rearmost Chassis	60-66	
E602433-S72	4-M6 Locknut as Clamp Assy to Chassis	6-8	
MS180604-S72	2-M8 Locknut Anti-Roll Bar Drop Link	15-19	
E820011-S72	12-M8 Bolt Driveshaft to Diff	23-25	
E620455-S72	2-M14 as Track Rod End to Track Rod	91-99	
MS180022-S72	2-Locknut M12 as Track Rod End to Stg Arm	56-62	
		2-M12 Bolt Steering Rack to Chassis	60-66
Front Drive Shafts			
Steering Rack			

RS200 TORQUE SETTINGS IN LBF/FT

INSPECTION ITEM	PART No.	DESCRIPTION	TORQUE	
Engine Mountings	MS182039-S72	2-M12 Locknut Steering Rack to Chassis	60-66	
	E600214-S72	1-M8 Bolt Strg Col Brkt Supp to Tube Assy	15-19	
	E620433-S72	1-M8 Locknut Strg Col Brkt Supp to Tube Assy	15-19	
	E600212-S72	4-M8 Bolt Strg Coupling to Strg Shafts	15-19	
	E620433-S72	4-M8 Locknut Coupling to Strg Shafts	15-19	
	E602168-S72	7-M6 Screw Brkt Assy Strg Col Mtg to Scuttle	6-8	
	E6204322-S72	7-M6 Locknut Brkt Assy Strg Col Mtg to Scuttle	6-8	
	E822025-S72	2-M10 Locknut Brkt Strg Col Supp to Brkt Assy Steering Column Mounting	32-36	
	E600122-S72	2-M6 Bolt Supp Ring Strg Col to Brkt Assy Strg Column Mounting	6-8	
	E620432-S72	2-M6 Locknut Ring Strg Col to Brkt Assy Strg Column Mounting	6-8	
Seat Belts	MS170011-S80	10-7/16 UNC Bolt, Engine Mtg to Eng L/H & R/H	28-32	
	MS180021-S72	2-M12 Bolt Plain Shank Eng Mtg to Chassis	60-66	
	E620333-S72	1-8M Thin Nut Rose Joint Supp Tube Lower	15-19	
	E600218-S72	1-8M Bolt Supp Tube Rose Joint to Eng Mtg Brkt	15-19	
	E620433-S72	1-M8 Locknut Tube Rose Joint to Eng Mtg Brkt	15-19	
	E600214-S72	1-M8 Bolt Supp Tube to Throttle Body Supp Brkt	15-19	
	E620433-S72	1-M8 Locknut Tube to Throttle Body Supp Brkt	15-19	
	E802278-S100	4- Socket Head Bolt Seat Belt to Seat	18-26	
	E602188-S72	8-M8 Screw Seat Assy to Floor	15-19	
	E600212-S72	8-M8 Screw Seat Slide to Seat	15-19	
Seats				
Steering Sheel	E822058-S72	1-M14 Nut Wheel to Column	91-99	
Door Assembly	E605273-S72	4-M6 Screw Striker Assy to Body	6-8	
	E602168-S72	18-M6 Screw Hinge Assy to door RH & LH	6-8	
	E602144-S72	4-M5 Screw Checkstrap Assy to Door RH & LH	3-5	
	E602549-S72	2-M8 Bolt Checkstrip Assy to 'A' post RH & LH	15-19	
	E600212-S72	8-M8 Bolt Hinge Assy to Pillar RH & LH	15-19	

RS200 TORQUE SETTINGS IN LBF/FT

Rear Body	E822013-S71 E602187-S72 E602187-S72	2-M6 Nut Hinge Assy RH & LH 6-M8 Screw Hinge Assy RH/LH to Rear End 6-M8 Screw Hinge Assy RH/LH to Centre Section	6-8 15-19 15-19
Front Dampers	MS180031-S72 MS182080-S72 MS182080-S72	4-M12 Bolt Fr Shock Assy to Frt Susp Mtg Frame 4-M12 Locknut Shock Assy to Frt Susp Mtg Frame 4-M12 Locknut Frt Shock Assy to Pin Damper Front	60-66 60-66 60-66
Rear Dampers	AS FRONT DAMPERS		

ALL NUT, BOLT AND SCREW HEADS TO BE MARKED ONCE CORRECT TORQUE SETTINGS HAVE BEEN ESTABLISHED

YOUR PERSONAL CONTACT AT FORD

08

WWW.RS200.ORG

To learn more about your RS200.....

We hope that this Manual, and the Newsletters which are circulated to registered RS200 owners, will give you a great deal of detailed knowledge about the specification and upkeep of this very special type of car.

There may, however, be some aspects of the design, or some detail of its behaviour in your hands, which encourage you to seek further information.

Although your FORD Rallye Sport Dealer may be able to help you, it is likely that the FORD factory has even more intimate knowledge of the car's behaviour, particularly in motorsport events.

If you want to know more, please contact:

**Ford Motor Company Limited,
Motorsport Parts Division,
Arisdale Avenue,
South Ockenden,
Essex,
England. RM15 5TJ
Telephone: 0708-858310
Telex: 897007**

WWW.RS200.ORG

AFTER-SALES NEWSLETTERS, AND BULLETINS 9

In the months and years following the building of the RS200 model in 1985, many improvements will be made to its specification, not only to optimise it for competition use, but to make it an even better and more satisfying road car.

As new parts and optional equipment, additional information, and competitions experience all become available, we plan to tell all our registered RS200 owners about them. To make sure of this, we need to keep a record of every car's owner, and this is why we have invited you to complete the Owner's Registration Form at the front of this booklet, and return it to us.

Whenever a newsletter, or bulletin, is produced, we will send it to the last registered owner of the car, completely without charge, and you will be able to add it to this manual, in the space allocated, immediately after this page.

We urge every RS200 owner to take advantage of this service, as it will enable him or her, and any subsequent owner, to keep up with developments, and help him always to have his car in the best, and the most reliable, condition.

WWW.RS200.ORG

ORIGINAL RS200 'PRESS PACK' INFORMATION 10

When the RS200 project was first revealed to the public on 12 November 1984, the company issued a comprehensive pack of information to members of the motoring press, so that they could tell their readers all about this exciting car.

Development of the car had not been completed, at that time, so certain details differed from the specification of your own car.

As a memento, however, and to remind you of the car in its original form, we have included a complete copy of the Press Pack in this manual. In years to come, it may remind you of the way FORD chose to tell the world about their very first mid-engined, four-wheel-drive, turbocharged, two-seater sports Coupe.

WWW.RS200.ORG

PARTS LIST 11

Index

	Page Nos.
Introduction.....	2
Model Identification.....	3
Parts List.....	3-6
Bill of Material.....	7

WWW.RS200.ORG

PARTS LIST

Introduction

Because the RS200 is only being built in limited numbers, and because there are so many special features in its design, we have included a complete list of all the parts, component assemblies, used to build the standard car.

Accordingly if the RS200 owner needs replacement parts for his car, even though it is normally housed many miles away from a specialist FORD motorsport dealer with expert knowledge of the model, he will be able to identify these parts, accurately, and secure replacements.

The list of parts printed below not only describes each item, and the number of them which are used in one car, but it defines each item in two different ways. One of these is the Part Number, and the other is the company's Finis Code.

Here is an example of the way that a component may be described:

68 VB 2K016 AA	(This is the Part No.)
1561895	(This is the Finis code)

If the Finis Code starts with the numbers: 909... , this means that the part is a special Motorsport item, and is serviced only by:

**Ford Motor Company Limited,
Motorsport Parts Division,
Arisdale Avenue,
South Ockenden,
Essex,
England. RM15 5TJ
Telephone: 0708-858512
Telex: 897007**

Should you or your dealer encounter difficulty in the supply of any Motorsport parts please call the RS200 24 hour - 'Hot Line' Answerphone Service - Telephone: 0708-858318.

Parts carrying any other Finis Code should, however, be serviced through the normal Ford service network, and not through Motorsport Parts.

Identification of FORD parts from other models

Every Part Number starts with a four-character, or five-character, prefix, which defines the model year, and the Ford vehicle, on which it was first used.

In the example quoted, therefore, the prefix 68 VB refers to a part first used in the 1968 model year. VB, in fact, was the Ford Transit.

Some Part Numbers begin with the letter 'H'. This denotes a special motor sport item, rather than one used on a 'mainstream' Ford product.

WWW.RS200.ORG

Model Identification

All European FORD Cars, and light commercial vehicles, are identified in the following way:

The First prefix letter refers to the vehicle product range.

The Second prefix letter refers to where it was built, or to the Assigning Location. In many cases this is also the location which had design responsibility for the item:

B = Britain, G = West Germany, and M = Motorsport

The various FORD models are as follows:

Escort/Orion	{ AB
	{ AG
	{ AM
Sierra	{ BB
	{ BG
Capri	{ EB
	{ EG
Fiesta	{ FB
	{ FG
Granada	{ GB
	{ GG
Overhead camshaft (German) engine range	HM
RS200 (ex-Escort RS1700T part)	MS
RS200 (special part)	PB
General Service part	SX
German engine range	TM
German transmission	TT
Transit range	VB

Parts List (Bill of Material) summary

The list of parts is arranged in the following order:

System	Sub-System	Description
00.02		Jack Tools & Misc. Safety Items
01.00	01.00.1	Body System
01.00	01.00.1	Body System
01.00	01.00.1	Body System
01.01	01.01.1/3	Body Structure
01.01	01.01./3/4/6	Body Structure
01.02	01.02.2	Front End
01.03		Doors & Mounting
01.04	01.04.1	Head Deck & Mounting
01.04	01.04.1/2	Head Deck & Mounting
01.04	01.04.2	Head Deck & Mounting
01.05		Trim
01.05		Trim
01.06		Heat Control
01.07	01.07.5/6	Body Sealing
01.07	01.07.5/6	Body Sealing
01.10		Seat, Seat Trim & Track
01.11	01.11.1/3	Glass Frames & Mechanism

System	Sub-System	Description
01.11	01.11.3/4/5	Glass Frames & Mechanism
01.11	01.11.5	Glass Frames & Mechanism
01.12		Instrument Panel & Console
01.13		Interior Ornamentation
01.14	01.14.3	Door Handles, Locks & Mechanism
01.14	01.14.3	Door Handles, Locks & Mechanism
01.14	01.14.3	Door Handles, Locks & Mechanism
01.15		Exterior Ornamentation
01.16		Windshield Wiper & Washer
01.16		Windshield Wiper & Washer
01.18		Body Paint
01.20		Safety Restraining
02.03		Engine Mounting
03.00		Engine
03.02	03.02.1	Engine Lubrication – Filter etc.
03.02	03.02.1/2/3	Engine Lubrication – Oil Tank & Seal
03.02	03.02.4	Engine Lubrication – Gasket
03.03		Engine Cooling
03.03		Engine Cooling
03.04	03.04.1/2/4	Induction Air – Intercooler – Air Cleaner Pipes
03.04		Throttle
03.06		Engine Starting
03.07		Engine Ignition
04.01	04.01.1	Front Suspension – Members
04.01	04.01.1	Front Suspension – Members
04.01	04.01.1	Front Suspension – Front Anti-Roll Bar
04.01	04.01.1	Front Suspension – Front Anti-Roll Bar
04.01	04.01.1	Front Suspension – Wishbone Upper
04.01	04.01.1	Front Suspension – Wishbone Upper
04.01	04.01.1	Front Suspension – Wishbone Lower
04.01	04.01.1	Front Suspension – Wishbone Lower
04.01	04.01.2	Front Springs
04.01	04.01.3	Front Hubs
04.01	04.01.3	Front Hubs
04.02	04.02.1	Rear Suspension Members – Frame
04.02	04.02.1	Rear Suspension Members – Frame
04.02	04.02.1	Rear Suspension Members – Frame
04.02	04.02.1	Rear Suspension Members – Frame
04.02	04.02.1	Rear Suspension – Rear Anti-Roll Bar

System	Sub-System	Description
04.02	04.02.1	Rear Suspension—Rear Anti-Roll Bar
04.02	04.02.1	Rear Suspension – Wishbone Upper
04.02	04.02.1	Rear Suspension – Wishbone Lower
04.02	04.02.2	Rear Springs
04.02	04.02.3	Rear Hubs, Bearings & Seals
04.02	04.02.3	Rear Hubs, Bearings & Seals
04.03		Shock Absorbers
04.03		Shock Absorbers
04.04		Wheels & Tyres
05.01		Driveshaft
05.01		Driveshaft
05.02		Rear Drive Axle
05.02		Rear Drive Axle
05.03		Front Drive Axle
06.01		Brakes
06.01		Brakes
06.01		Brakes
06.01		Brakes
06.01		Brakes
06.01		Brakes
06.02		Parking Brake
06.02		Parking Brake
07.03		Manual Transmission
07.03		Manual Transmission
07.06		Manual Transmission External Controls
07.06		Manual Transmission External Controls
07.06		Manual Transmission External Controls
07.06		Manual Transmission External Controls
07.07		Transfer Box
08.01		Clutch & Housing
08.01		Clutch & Housing
08.02		Clutch Controls
08.02		Clutch Controls
09.00		Exhaust System
09.00		Exhaust System
10.00		Fuel Tank & Lines
10.00		Fuel Tank & Lines
10.00		Fuel Tank & Lines

WWW.RS200.ORG

System	Sub-System	Description
10.00		Fuel Tank & Lines
10.00		Fuel Tank & Lines
11.01		Manual Steering
11.01		Manual Steering
11.05		Steering Column & Wheel
11.05		Steering Column & Wheel
11.05		Steering Column & Wheel
12.01		Body Ventilation
12.02		Heating & Distribution
13.02		Speedometer
13.03		Fuel Gauge
13.04		Electrical Power Gauges
13.05		Engine Operation Gauges
13.06		Horn
13.07		Misc. Gauges
14.01		Battery Support
14.02		Generator/Alternator
14.08		Battery Cables & Fixings
14.09		Low Tension, Low Current Distribution – Wiring
14.10		Low Tension, Low Current Distribution – Switches
15.01		Sound Receiving
15.02		Radio Aerial
17.01		Front Lighting
17.02		Interior Lighting
17.03		Rear Lighting
		Miscellaneous

WWW.RS200.ORG